

SELECTAkit®

Waste
collectors

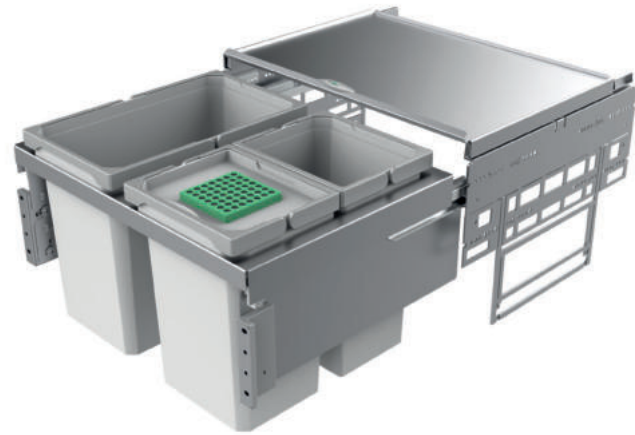

Waste
collectors

Intelligence



Clean waste separation conserves natural resources. At the same time, keeping the base cabinet well organised saves time and is conveniently sustainable. In this way, SELECTAkit® waste separation systems make responsible ecological thinking simple!

Because the SELECTAkit® waste collector range, creatively developed over many years, provides the optimum waste separation system with precisely fitting storage space organisation for every kitchen base unit. They are highly practical, versatile and flexible: Cox® Base, Cox StandUP®, Cox Clan®, Cabbi® ... And with Cox Base-Board® and Cox Work® you have tailor-made organisation and storage systems on top.

That means: undreamt-of storage possibilities for accessories and utensils, combined with highly functional and ergonomic design.

SELECTAkit®

Waste collectors

Innovative technology
is developed from new thinking



Waste
collectors



SELECTAkit®
Pull-out technology for front pull-outs
The sophisticated
pull-out technology Page 139–180



SELECTAkit®
Pull-out technology for existing pull-outs
The flexible
waste system Page 181–208



SELECTAkit®
Pull-out technology for rotating doors
The perfect supplement for
functionality and ergonomics Page 209–232



SELECTAkit®
Swivel technology for rotating doors
The technology
of shorter distances Page 233–242



SELECTAkit®
Built-in containers/Waste disposal units
Extremely practical
and shapely Page 243–246

Collectors overview

Pull-out technology for front pull-out

Page 139–180



Full front
Front panel with one division

Depth 320 mm	Page
Cox® Base 360 K	152–153, 155
Cox Base-Board®	148–151, 154
Depth 330 mm	Page
Pullboy Soft Comm®	161–164
Pullboy Soft Fusion®	165–166
Depth 400 mm	Page
Cox® Base 360 S	141–143, 149–150
Cox® Base Q+	145
Cox® Base Q	146
Cox Base-Board®	148–151, 154
Cox Base-Board® 900	151
Cox® Base 360 S/900–4	151
Cox Cick-E® 600	150
Cox Cick-E® 600 K	155
Cox® Base 460 S	156–158
Cox Cick®	159
LED Fußkick Libero 3.0	159
Cox® Base 360 R	167–168
Cox® Base 460 R	169–170
Depth > 400 mm	Page
Cox Clan®	172–175
Cox Cick®	173
Profiline Double-Boy® 410 S/300–2	178
Traditionline Double-Master® 585 S/400–2	178
Traditionline Trio-Master® 410 S/400–3	178
Müllex Boxx 55/60–R Bio	179
Müllex Euro Boxx 55/60 R	179
StopMatic	179
KickMatic	180

Pull-out technology for existing pull-outs

Page 181–208



Full front
Front panel with one division
Front panel with one division
Front panel with two divisions

Depth 310 mm	Page
Cox Stand-UP® 350 K	192–193
Depth 400 mm	Page
Cox Stand-UP® 250 S	183–185
Cox Stand-UP® 280 S	186–188
Cox Stand-UP® 350 S	189–191
Depth > 400 mm	Page
Tandem 2	193
Pullboy Vario 335 S/300–2	195
Pullboy Vario 320 S/400–2	195
Pullboy Vario 320 S/450–2	196
Pullboy Vario 320 S/500–3	197
Pullboy Vario 320 S/600–4	196
Pullboy Vario 300 S/800–4	196
Pullboy Versa® 265 K/500–2	199
Pullboy Versa® 265 K/500–3	199
Pullboy Versa® 265 K/600–2	200
Pullboy Versa® 265 K/600–3	200
Pullboy Versa® 265 K/600–4	200
Pullboy Versa® 265 K/800–4	201
Pullboy Versa® 265 K/900–4	201
Pullboy Versa® 265 K/1000–4	201
Pullboy Versa® 265 S/500–3	202
Pullboy Versa® 265 S/500–4	202
Pullboy Versa® 265 S/600–4	203
Pullboy Versa® 265 S/800–4	203
Pullboy Versa® 265 S/900–4	203
Pullboy Versa® 265 S/1000–4	204
Cox® Giallo	205
X-LINE	206–207

Pull-out technology for rotating doors

Page 209–232



Full front
Front panel with one division

	Page
Clap 1–3	210–212
Traditionline Double-Boy® 410 X	213
Traditionline Double-Boy® 410 ECO	213
Traditionline Double-Boy® 410 S	213
Traditionline Trio-Boy® 410 S	214
Traditionline Single-Boy® 485 K	214
Traditionline Single-Boy® 545 S	214
Traditionline Single-Boy® 550 S	215
Traditionline Double-Master® 410 S	215
Traditionline Trio-Master® 410 S	215
Traditionline Double-Master® 345 S	216
Traditionline Double-Master® 485 S	216
Traditionline Trio-Master® 345 S	216
Traditionline Double-Shorty® 345 K	217
Traditionline Trio-Shorty® 345 K	217
Traditionline Double-Shorty® 345 K	218
Profiline Double-Boy® 345 S	218
Profiline Double-Boy® 410 S	218
Profiline Trio-Boy® 345 S	219
Profiline Trio-Boy® 410 S	219
Profiline Double-Master® 345 S	219
Profiline Double-Master® 410 S	220
Profiline Trio-Master® 345 S	220
Profiline Trio-Master® 410 S	220
Solo 3635/3636	221
Tandem 8	221
Cleaning agent pullout Carry	222
Tandem 7 K/S	222–224
Tandem 4/5	224
Easy Cargo 1	225
Corner solutions	Page
Traditionline Double-Master® Corner	226
Rondo® plus	227–228
Rolling cart DS	230
Profiline Double-Master® DS	230–231
Traditionline Double-Master® DS	231

Collectors overview

Swivel technology for rotating doors

Page 233–242



Full front



Front panel with one division

	Page
Cabbi® junior	235
Cabbi®	236–237
Cox® Beep	238
Müllex Single 35	239
Müllex Euro Flexx	239
Klassikline Single-Junior®	240
Klassikline Double-Junior®	240
Rondo® 2	241
Uno 3418	242
Duo 3416	242

Built-in containers/ Waste disposal units

Page 243–246



	Page
Dassa	244
Premium 700 EC	245
Premium 550 EC	246

SELECTAkIt®

Pull-out technology for front pull-out

The sophisticated pull-out technology



Waste collectors

Cox® Base 360 S	Page 141–143	Pullboy Soft Comfort® 495 K	Page 164
Cox® Base Q	Page 144–146	Pullboy Soft Fusion® 320 K	Page 165
Cox Base-Board®	Page 147–148	Pullboy Soft Fusion® 480 K	Page 166
Cox® Base 360 S with Base-Board®	Page 149–150	Foot kick	Page 166
Cox Cick-E® 600	Page 150	Cox® Base 360 R	Page 167–168
Cox Base-Board® 900	Page 151	Cox® Base 460 R	Page 169–170
Cox® Base 360 S/900-4	Page 151	Cox Clan® 490	Page 171–173
Cox® Base 360 K	Page 152–153	Cox Cick®	Page 173
Cox Base-Board®	Page 154	Cox Clan® 580	Page 174–175
Cox® Base 360 K with Base-Board®	Page 155	Replacement bucket and lid overview	Page 176–177
Cox Cick-E® 600 K	Page 155	Profiline Double-Boy® 410 S	Page 178
Cox® Base 460 S	Page 156–158	Traditionline Double-Master® 585 S	Page 178
Cox® Base Einzeleimer	Page 158	Traditionline Trio-Master® 410 S	Page 178
Cox Cick®	Page 159	Müllex	Page 179
LED foot kick Libero 3.0	Page 159	StopMatic	Page 179
Pullboy Soft Comfort® 335 K	Page 160–162	KickMatic	Page 180
Pullboy Soft Comfort® 360 K	Page 162–163		

Suitable for the following front layouts:



Full front



Front panel with one division

Please check the heights of the product groups.

SELECTAkit®

Pull-out technology with front pull-out

COX® Base

is the sophisticated built-in waste collector solution, convincing due to high quality, convenient handling and perfect pull-out technology.

- GRASS self-retractable full pull-out technology with synchronization, Airmatic soft-impact proven in long-term tests
- smooth operation and lateral stability even under full load (load bearing capacity 40 kg)
- reinforced metal housing frame for container holder, powder-coated
- extractable metal lid with grip clip, may be used as an additional deposit, powder-coated
- available for four cupboard widths as well as with standard and XXL containers, installation depth of only 400 mm
- optional 10 l container with bio-lid and activated charcoal filter
- exactly fitting assembly using the "quick & easy" quick assembly frame

Cox® Base – competitive edge due to perfectly attenuated pull-out technology



Cox® Base convinces due to easy assembly:



1. Insert GRASS-guide 470 mm into the side part and assemble flush with the body (quick & easy).



2. Slide depositing lid into the plastic sliding bearing.



3. Insert pull-out frame into the pull-out rails.



4. Install front attachment using the template.



5. Insert front plate into the pull-out frame and fasten it.



6. Insert container. Finished!



Cox® Base 360 S

- Waste collector as front pull-out system with soft retraction and damping.
- installation height 360 mm
- installation depth 400 mm
- **depth of the guide rail 470 mm**
- "quick&easy" installation frame for different body thicknesses (16/19 mm)
- "nova Pro" guide rail
- functional design

		Container fitting system/litres							
Cabinetbody		400	450	500		600		900	
	10			16	10	10	22	22	10
	10				10	10			10
	22		16	16	16	22	22	22	1,2
								2,7	2,7
						10	10		
						10	10		

Waste collectors

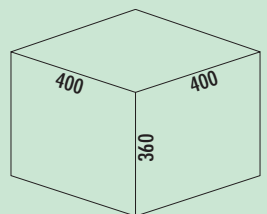

Cox® Base 360 S/400-1

- With pull-out complete lid.
- guide rail depth 470 mm
- waste capacity 22 liters
- technology: full drawer
- fitting: cabinet wall and front panel
- **with soft retraction and damping**



8012310	light grey, H 360 mm	€ 313.33
8013310	anthracite, H 360 mm	€ 313.33

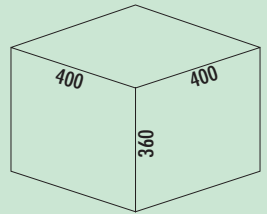

Cox® Base 360 S/400-2

- With pull-out complete lid.
- guide rail depth 470 mm
- waste capacity 20 (2 x 10) liters
- technology: full pull-out
- fitting: cabinet wall and front panel
- **with soft retraction and damping**



8012300	without bio lid, light grey, H 360 mm	€ 313.33
8013300	without bio lid, anthracite, H 360 mm	€ 313.33
8012313	with bio lid, light grey, H 360 mm	€ 318.09
8013313	with bio lid, anthracite, H 360 mm	€ 318.09

Optional accessories

8011312	Bio-lid, light grey, for 4/ 6/ 7/ 10/ 12.5 liters	€ 15.45
8013312	Bio-lid, anthracite, for 4/ 6/ 7/ 10/ 12.5 liters	€ 15.45
8011178	Bio-filter retrofitting set, black	€ 7.71

SELECTAkitt[®] Pull-out technology for front pull-out

Order no. Description

per piece excl. VAT

Waste collectors

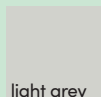
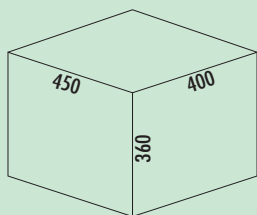

Cox[®] Base 360 S/450-2

- With pull-out complete lid.
- guide rail depth 470 mm
- waste capacity 32 (2 x 16) liters
- technology: full pull-out
- fitting: cabinet wall and front panel
- with soft retraction and damping

8012301	light grey, H 360 mm	€ 331.24
8013301	anthracite, H 360 mm	€ 331.24

Optional accessories

8012367	Cox Cick [®] , dark grey/chrome matt	€ 69.43
---------	---	---------

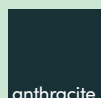
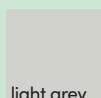
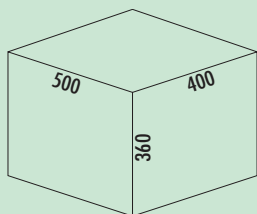

Cox[®] Base 360 S/500-2

- With pull-out complete lid.
- guide rail depth 470 mm
- waste capacity 38 (1 x 16/1 x 22) liters
- technology: full pull-out
- fitting: cabinet wall and front panel
- with soft retraction and damping

8012303	light grey, H 360 mm	€ 339.66
8013303	anthracite, H 360 mm	€ 339.66

Optional accessories

8012367	Cox Cick [®] , dark grey/chrome matt	€ 69.43
---------	---	---------

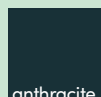
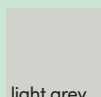
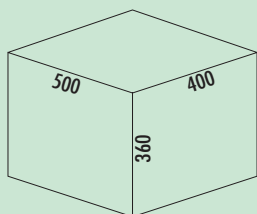

Cox[®] Base 360 S/500-3

- With pull-out complete lid.
- guide rail depth 470 mm
- waste capacity 36 (2 x 10/1 x 16) liters
- technology: full pull-out
- fitting: cabinet wall and front panel
- with soft retraction and damping

8012302	without bio lid, light grey, H 360 mm	€ 339.66
8013302	without bio lid, anthracite, H 360 mm	€ 339.66
8012314	with bio lid, light grey, H 360 mm	€ 344.45
8013314	with bio lid, anthracite, H 360 mm	€ 344.45

Optional accessories

8011312	Bio-lid, light grey, for 4/ 6/ 7/ 10/ 12.5 liters	€ 15.45
8013312	Bio-lid, anthracite, for 4/ 6/ 7/ 10/ 12.5 liters	€ 15.45
8011178	Bio-filter retrofitting set, black	€ 7.71
8012367	Cox Cick [®] , dark grey/chrome matt	€ 69.43

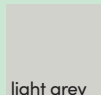
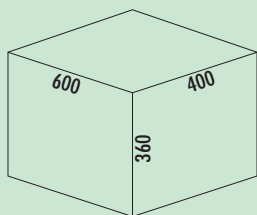

Cox® Base 360 S/600-2

- With pull-out complete lid.
- guide rail depth 470 mm
- waste capacity 44 (2 x 22) liters
- technology: full pull-out
- fitting: cabinet wall and front panel
- with soft retraction and damping

8012304	light grey, H 360 mm	€ 339.66
8013304	anthracite, H 360 mm	€ 339.66

Optional accessories

8012368	Cox Cick-E® 600, W 600 mm, dark grey/chrome matt	€ 490.71
8012367	Cox Cick®, dark grey/chrome matt	€ 69.43

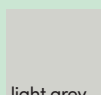
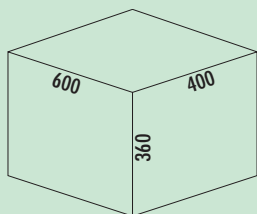

Cox® Base 360 S/600-3

- With pull-out complete lid.
- guide rail depth 470 mm
- waste capacity 42 (2 x 10/1 x 22) liters
- technology: full pull-out
- fitting: cabinet wall and front panel
- with soft retraction and damping

8012305	without bio lid, light grey, H 360 mm	€ 340.54
8013305	without bio lid, anthracite, H 360 mm	€ 340.54
8012315	with bio lid, light grey, H 360 mm	€ 355.98
8013315	with bio lid, anthracite, H 360 mm	€ 355.98

Optional accessories

8011312	Bio-lid, light grey, for 4/ 6/ 7/ 10/ 12.5 liters	€ 15.45
8013312	Bio-lid, anthracite, for 4/ 6/ 7/ 10/ 12.5 liters	€ 15.45
8011178	Bio-filter retrofitting set, black	€ 7.71
8012368	Cox Cick-E® 600, W 600 mm, dark grey/chrome matt	€ 490.71
8012367	Cox Cick®, dark grey/chrome matt	€ 69.43

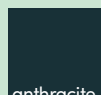
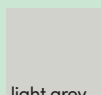
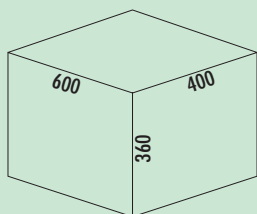

Cox® Base 360 S/600-4

- With pull-out complete lid.
- guide rail depth 470 mm
- waste capacity 40 (4 x 10) liters
- technology: full pull-out
- fitting: cabinet wall and front panel
- with soft retraction and damping

8012316	without bio lid, light grey, H 360 mm	€ 381.87
8013316	without bio lid, anthracite, H 360 mm	€ 381.87
8012317	with bio lid, light grey, H 360 mm	€ 384.41
8013317	with bio lid, anthracite, H 360 mm	€ 384.41

Optional accessories

8011312	Bio-lid, light grey, for 4/ 6/ 7/ 10/ 12.5 liters	€ 15.45
8013312	Bio-lid, anthracite, for 4/ 6/ 7/ 10/ 12.5 liters	€ 15.45
8011178	Bio-filter retrofitting set, black	€ 7.71
8012368	Cox Cick-E® 600, W 600 mm, dark grey/chrome matt	€ 490.71

Waste collectors

SELECTAkit®

Pull-out technology with front pull-out

Cox® Base Q+/ Cox® Base Q



Waste collector systems from Naber combine optimum storage space organisation with maximum ease of use. Cox® Base Q+/Cox® Base Q enables space-saving accommodation of waste containers and Quooker water tanks in the base cabinet of the sink.

The convenient dispensing of boiling hot and chilled sparkling water simply by operating the Quooker faucet is based on the water tank plus hoses and water connections. With Cox® Base Q+/Cox® Base Q, the equipment is accommodated in a stable frame next to the waste collectors.

Cox® Base Q+/Cox® Base Q provides at least 20 litres of waste volume. The portable utensil box Cox Work® can be integrated into one variant, and the special lid for compostable organic waste into another. The waste system is equipped with a complete lid where utensils can be stowed.

- Accommodation of the Quooker PRO3, COMBI, COMBI+ boiling water tank and the Quooker CUBE cold water tank with CO2 cylinder.
- including an organisation aid for the cable and hose routing
- with a separate mount for the Quooker water filter
- for 600 mm wide base cabinets
- technology: full pull-out with soft retraction and damping
- colour of frame/rack/guide/complete lid: anthracite
- mounting on cabinet wall, cabinet base and front panel
- connection of the Quooker tank and the faucet to the corner valve is executed in front of the furniture. After that, the frame element with Cube, PRO3 tank, COMBI, COMBI+ and CO2 cylinder is inserted and fastened with screws.
- simple removal by loosening two screws for maintenance work



Cox® Base Q+ 360 S/370-1



Cox® Base Q 360 S/400-2



Cox® Base Q+ **Quooker®**

The waste system Cox Base Q+ 360 S/370 allows optimum organisation of the storage space in the sink unit. Suitable for the Quooker Cube cold water reservoir and the Pro3 boiling water reservoir as well as for the 7-litre tanks of the Quooker Combi and Combi+ models. The system can be installed in a kitchen cabinet with a width of **600 mm** and a front pull-out. The waste separation system features two waste containers, each with a volume of 10 litres, making the total volume 20 litres. The housing cover is used as a lid, which also doubles as a shelf.

In addition, the waste collection system has a **separate rack for the water tank, which can be positioned either on the right or left of the cabinet**. A hose and cable management system is integrated into this for clear storage. The installation frame also enables quick and easy replacement of the CO₂ cylinder. The waste separation system is easy to operate thanks to its full pull-out technology. The integration of a soft closing mechanism and damping makes for quiet closing. The entire construction is mounted on the side panel, the bottom shelf and the front panel of the cabinet.

Container fitting system/litres	
Cabinet body	600
	22
	10
	10

Waste collectors

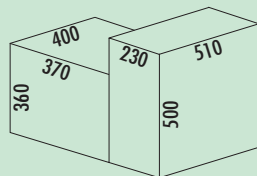

Cox® Base Q+ 360 S/370-1 **Quooker®**

For positioning in a sink base unit with a width of **600 mm**.

- simple, quick and flexible installation
- positioning of the reservoirs on the left or on the right of the Cox® Base possible
- sturdy construction for mounting on the cabinet side wall, front panel and on the underside
- integrated hose and cable management
- simple replacement of the CO₂ cylinder
- waste volume 22 litres
- waste system with soft retraction and damping



8013378 anthracite, H 360 mm	€ 520.47
-------------------------------------	-----------------

Optional accessories

1051017 Space-saving connector, white	€ 5.88
8013367 Holder for CUBE filter	€ 71.09

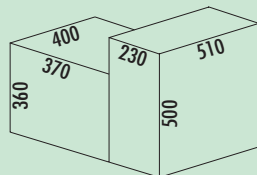

Cox® Base Q+ 360 S/370-2 **Quooker®**

For positioning in a sink base unit with a width of **600 mm**.

- simple, quick and flexible installation
- positioning of the reservoirs on the left or on the right of the Cox® Base possible
- sturdy construction for mounting on the cabinet side wall, front panel and on the underside
- integrated hose and cable management
- simple replacement of the CO₂ cylinder
- waste volume 20 (2 X 10) litres
- waste system with soft retraction and damping



8013379 anthracite, H 360 mm	€ 520.47
-------------------------------------	-----------------

Optional accessories

8013312 Bio-lid, anthracite, for 4/ 6/ 7/ 10/ 12.5 liters	€ 15.45
1051017 Space-saving connector, white	€ 5.88
8013367 Holder for CUBE filter	€ 71.09

SELECTAkIt® Pull-out technology for front pull-out

Order no. Description

per piece excl. VAT

Waste collectors

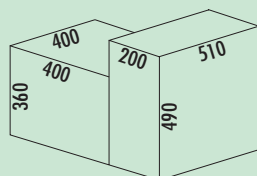

Cox® Base Q 360 S/400-1

Quooker®

For positioning in a sink base unit with a width of 600 mm.

- simple, quick and flexible installation
- positioning of the reservoirs on the left or on the right of the Cox® Base possible
- sturdy construction for mounting on the cabinet side wall, front panel and on the underside
- integrated hose and cable management
- simple replacement of the CO₂ cylinder
- Quooker system can be set up and connected in front of the cabinet. The extension hoses required for this are listed below as accessories and can be ordered directly from Quooker.
- waste volume 22 litres
- waste system with soft retraction and damping

8013347 anthracite, H 360 mm € 520.47

Optional accessories

1051017 Space-saving connector, white € 5.88

8013367 Holder for CUBE filter € 71.09

VERLKALT Supply line extension for the PRO3, 700 mm

VERLEQ60 Extension of the boiling water hose from the PRO3 to the tap, 600 mm

VERLCUBE extension of the supply line CUBE, 600 mm

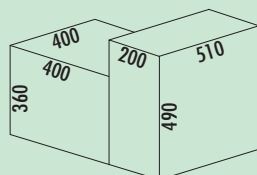

Cox® Base Q 360 S/400-2

Quooker®

For positioning in a sink base unit with a width of 600 mm.

- simple, quick and flexible installation
- positioning of the reservoirs on the left or on the right of the Cox® Base possible
- sturdy construction for mounting on the cabinet side wall, front panel and on the underside
- integrated hose and cable management
- simple replacement of the CO₂ cylinder
- Quooker system can be set up and connected in front of the cabinet. The extension hoses required for this are listed below as accessories and can be ordered directly from Quooker.
- waste volume 20(2 X 10) litres
- waste system with soft retraction and damping

8013348 anthracite, H 360 mm € 520.47

Optional accessories

8013312 Bio-lid, anthracite, for 4/ 6/ 7/ 10/ 12.5 liters € 15.45

1051017 Space-saving connector, white € 5.88

8013367 Holder for CUBE filter € 71.09

VERLKALT Supply line extension for the PRO3, 700 mm

VERLEQ60 Extension of the boiling water hose from the PRO3 to the tap, 600 mm

VERLCUBE extension of the supply line CUBE, 600 mm

SELECTAkit®

Pull-out technology with front pull-out

COX Base-Board®

Cox Base Board® is a perfect supplement to the Cox® Base waste collector, convincing due to high quality, convenient handling and perfect pull-out technology.

- GRASS self-retracting full pull-out technology with self-closing and Airmatic soft-impact proven in long-term tests
- smooth operation and lateral stability even under full load
- stable metal frame, powder-coated
- optimum fit of the plastic containers
- perfect use of space in the base cabinet due to flexible positioning of the containers
- available for cupboard widths 500 mm, 600 mm and 900 mm
- exactly fitting assembly using the "quick & easy" assembly plate, also suitable for the retrofitting of existing Cox® Base waste collectors

Cox Base-Board® – competitive edge due to perfectly attenuated pull-out technology!



Cox Base-Board® convinces due to easy assembly:



1. Pull out the depositing lid of the existing Cox® Base waste system.



2. Insert GRASS guide into the mounting plate, attach to the existing Cox® Base plastic rail and mount flush to the body ("quick & easy").



3. Replace the depositing lid of the existing Cox® Base waste system.



4. Mount the metal frame on the pull-out rails.



5. Attach container to the metal frame with the supplied brackets.



6. Mount the pull-out frame on the pull-out rails with the front connection. Finished!

SELECTAkIt® Pull-out technology for front pull-out

Order no. Description

per piece excl. VAT

Waste collectors



Cox Base-Board®

Cox Base Board® is a perfect supplement to the Cox® Base waste collector, convincing due to high quality, convenient handling and perfect pull-out technology:

- H 100 mm
- **depth of the guide rail 470 mm**
- GRASS self-retracting full pull-out technology with Airmatic soft-impact, proven in long-term tests
- smooth operation and lateral stability even under full load
- stable metal frame, powder-coated
- optimal utilisation of space of storage boxes by flexible positioning of the boxes by means of separate brackets
- available for cupboard widths 500, 600 and 900 mm
- exactly fitting assembly using the "quick & easy" assembly plate, also suitable for the retrofitting of existing Cox® Base waste collectors

Cox Base-Board® – competitive edge due to perfectly attenuated pull-out technology!

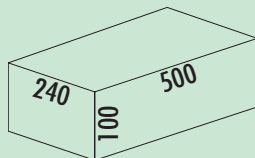

Cox Base-Board® 500

- height 100 mm
- guide rail depth 470 mm
- uniform design to Cox® Base
- technology: full pull-out
- fitting: cabinet wall
- **with soft retraction and damping**
- **boîtes de rangement 1 x 2,7 l et 1 x 1,2 l et 4 fixations incluses**

8012360 silver € 232.67

8013360 anthracite € 232.67

Optional accessories

8012362 Storage box, dark grey, 2.7 liters € 14.48

8013362 Storage box, anthracite, 2.7 liters € 14.48

8012363 Storage box, dark grey, 1.2 liters € 12.02

8013363 Storage box, anthracite, 1.2 liters € 12.02

8012364 Bracket for storage box, silver € 2.19

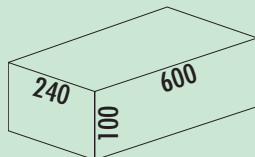
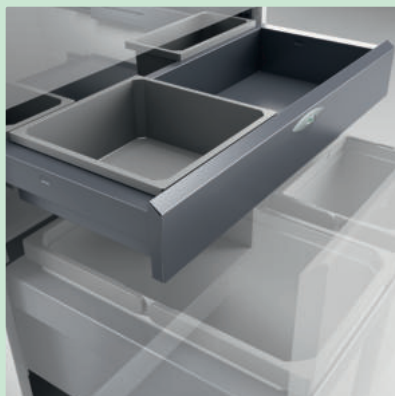

Cox Base-Board® 600

- height 100 mm
- guide rail depth 470 mm
- uniform design to Cox® Base
- technology: full pull-out
- fitting: cabinet wall
- **with soft retraction and damping**
- **1 x 2.7 l and 1 x 1.2 l storage boxes and 4 brackets included**

8012361 silver € 232.67

8013361 anthracite € 232.67

Optional accessories

8012362 Storage box, dark grey, 2.7 liters € 14.48

8013362 Storage box, anthracite, 2.7 liters € 14.48

8012363 Storage box, dark grey, 1.2 liters € 12.02

8013363 Storage box, anthracite, 1.2 liters € 12.02

8012364 Bracket for storage box, silver € 2.19



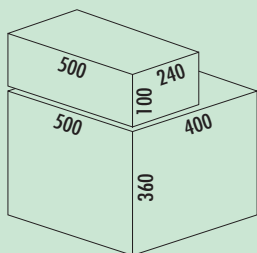

Cox® Base 360 S/500-2 with Base-Board

- guide rail depth 470 mm
- waste capacity 38 (1 x 16/1 x 22) liters
- technology: full pull-out
- fitting: cabinet wall and front panel
- **with soft retraction and damping**
- **1 x 2.7 l and 1 x 1.2 l storage boxes and 4 brackets included**

8012370	light grey, H 460 mm	€ 535.13
8013370	anthracite, H 460 mm	€ 535.13

Optional accessories

8012367	Cox Cick®, dark grey/chrome matt	€ 69.43
---------	----------------------------------	---------

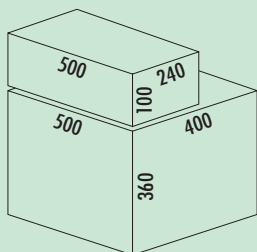
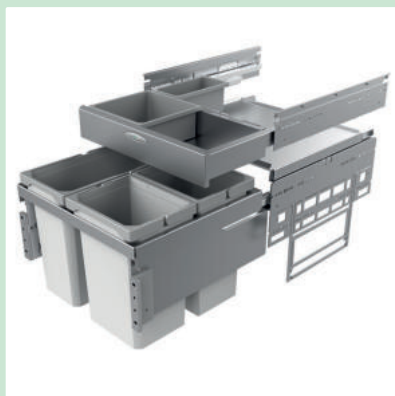

Cox® Base 360 S/500-3 with Base-Board

- guide rail depth 470 mm
- waste capacity 36 (2 x 10/1 x 16) liters
- technology: full pull-out
- fitting: cabinet wall and front panel
- **with soft retraction and damping**
- **1 x 2.7 l and 1 x 1.2 l storage boxes and 4 brackets included**

8012371	without bio lid, light grey, H 460 mm	€ 535.13
8012372	with bio lid, light grey, H 460 mm	€ 548.10
8013371	without bio lid, anthracite, H 460 mm	€ 535.13
8013372	with bio lid, anthracite, H 460 mm	€ 548.10

Optional accessories

8011312	Bio-lid, light grey, for 4/ 6/ 7/ 10/ 12.5 liters	€ 15.45
8013312	Bio-lid, anthracite, for 4/ 6/ 7/ 10/ 12.5 liters	€ 15.45
8012367	Cox Cick®, dark grey/chrome matt	€ 69.43

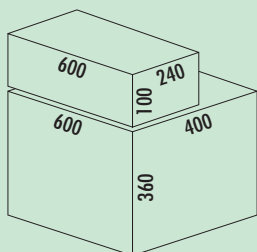

Cox® Base 360 S/600-2 with Base-Board

- guide rail depth 470 mm
- waste capacity 44 (2 x 22) liters
- technology: full pull-out
- fitting: cabinet wall and front panel
- **with soft retraction and damping**
- **1 x 2.7 l and 1 x 1.2 l storage boxes and 4 brackets included**

8012373	light grey, H 460 mm	€ 546.58
8013373	anthracite, H 460 mm	€ 546.58

Optional accessories

8012368	Cox Cick-E® 600, W 600 mm, dark grey/chrome matt	€ 490.71
8012367	Cox Cick®, dark grey/chrome matt	€ 69.43

Waste collectors

SELECTAkIt® Pull-out technology for front pull-out

Order no. Description

per piece excl. VAT

Waste collectors

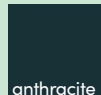
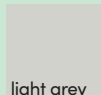
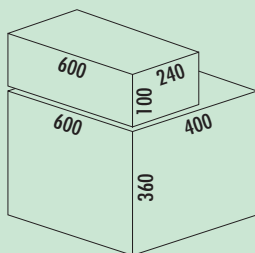

Cox® Base 360 S/600-3 with Base-Board

- guide rail depth 470 mm
- waste capacity 42 (2 x 10/1 x 22) liters
- technology: full pull-out
- fitting: cabinet wall and front panel
- **with soft retraction and damping**
- **1 x 2.7 l and 1 x 1.2 l storage boxes and 4 brackets included**

8012374	without bio lid, light grey, H 460 mm	€ 547.41
8012375	with bio lid, light grey, H 460 mm	€ 565.11
8013374	without bio lid, anthracite, H 460 mm	€ 547.41
8013375	with bio lid, anthracite, H 460 mm	€ 565.11

Optional accessories

8011312	Bio-lid, light grey, for 4/ 6/ 7/ 10/ 12.5 liters	€ 15.45
8013312	Bio-lid, anthracite, for 4/ 6/ 7/ 10/ 12.5 liters	€ 15.45
8012368	Cox Cick-E® 600, W 600 mm, dark grey/chrome matt	€ 490.71
8012367	Cox Cick®, dark grey/chrome matt	€ 69.43

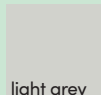
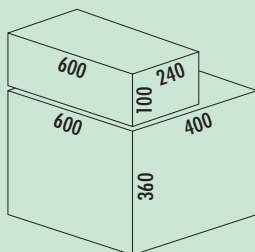

Cox® Base 360 S/600-4 with Base-Board

- guide rail depth 470 mm
- waste capacity 40 (4 x 10) liters
- technology: full drawer
- fitting: cabinet wall and front panel
- **with soft retraction and damping**
- **1 x 2.7 l and 1 x 1.2 l storage boxes and 4 brackets included**

8012376	without bio lid, light grey, H 460 mm	€ 571.53
8012377	with bio lid, light grey, H 460 mm	€ 590.62
8013376	without bio lid, anthracite, H 460 mm	€ 571.53
8013377	with bio lid, anthracite, H 460 mm	€ 590.62

Optional accessories

8011312	Bio-lid, light grey, for 4/ 6/ 7/ 10/ 12.5 liters	€ 15.45
8013312	Bio-lid, anthracite, for 4/ 6/ 7/ 10/ 12.5 liters	€ 15.45
8012368	Cox Cick-E® 600, W 600 mm, dark grey/chrome matt	€ 490.71



Cox Cick-E® 600



- **electric ejector for Cox® waste collectors**
- **suitable for Cox® Base waste collector with 400 mm installation depth and 600 mm width**
- space-saving and invisible installation behind the waste collectors
- activation of pull-out mechanism by gently touching the pull-out front
- alternative mounting positions to avoid obstacles on site (e.g. water connection)
- attachment of the crossbar to existing holes of the Cox® waste collector
- 230 V electrical connection
- compatible waste collectors: 8012304, 8013304, 8012305, 8013305, 8012315, 8013315, 8012308, 8013308, 8012316, 8013316, 8012317, 8013317, 8012373, 8013373, 8012374, 8013374, 8012375, 8013375, 8012377, 8013377, 8012376, 8013376, 8012406, 8013406, 8012446, 8013446, 8012354, 8013354

8012368	W 600 mm, dark grey/chrome matt	€ 490.71
---------	---------------------------------	----------



Cox Base-Board®

Cox Base Board® is a perfect supplement to the Cox® Base waste collector, convincing due to high quality, convenient handling and perfect pull-out technology:

- H 100 mm
- **depth of the guide rail 470 mm**
- GRASS self-retracting full pull-out technology with Airmatic soft-impact, proven in long-term tests
- smooth operation and lateral stability even under full load
- stable metal frame, powder-coated
- optimal utilisation of space of storage boxes by flexible positioning of the boxes by means of separate brackets
- available for cupboard widths 500, 600 and 900 mm
- exactly fitting assembly using the "quick & easy" assembly plate, also suitable for the retrofitting of existing Cox® Base waste collectors

Cox Base-Board® – competitive edge due to perfectly attenuated pull-out technology!

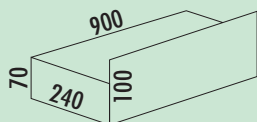

Cox Base-Board® 900

- height 100 mm
- guide rail depth 470 mm
- uniform design to Cox® Base
- technology: full pull-out
- fitting: cabinet wall
- **with soft retraction and damping**
- **2 x 2.7 l and 2 x 1.2 l storage boxes and 4 brackets included**

8012551 silver € 253.29

8013551 anthracite € 253.29

Optional accessories

8012362 Storage box, dark grey, 2.7 liters € 14.48

8013362 Storage box, anthracite, 2.7 liters € 14.48

8012363 Storage box, dark grey, 1.2 liters € 12.02

8013363 Storage box, anthracite, 1.2 liters € 12.02

8012364 Bracket for storage box, silver € 2.19

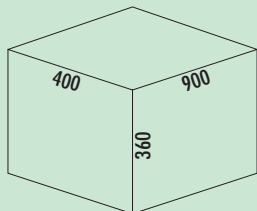

Cox® Base 360 S/900-4

With pull-out complete lid.

- guide rail depth 470 mm
- waste capacity 64 (2 x 10/2 x 22) liters
- technology: full drawer
- fitting: cabinet wall and front panel
- **with soft retraction and damping**

8012550 without bio lid, light grey, H 360 mm € 455.08

8013550 without bio lid, anthracite, H 360 mm € 455.08

8012552 with bio lid, light grey, H 360 mm € 466.99

8013552 with bio lid, anthracite, H 360 mm € 466.99

Optional accessories

8011312 Bio-lid, light grey, for 4/ 6/ 7/ 10/ 12.5 liters € 15.45

8013312 Bio-lid, anthracite, for 4/ 6/ 7/ 10/ 12.5 liters € 15.45

8011178 Bio-filter retrofitting set, black € 7.71

8012367 Cox Cick®, dark grey/chrome matt € 69.43

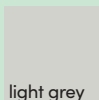



Cox[®] Base 360 K

- Waste collector as front pull-out system with soft retraction and damping.
- installation height 360 mm
 - **installation depth 320 mm**
 - **due to the reduced depth, devices can be installed behind (e.g. boiler)**
 - **depth of the guide rail 470 mm**
 - "quick&easy" installation frame for various cabinet thicknesses (16/19 mm)
 - "nova Pro" guide rail
 - functional design

Container fitting system/litres		
Cabinet body	500	600
	12 15.5	15.5 15.5

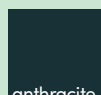
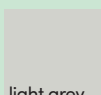
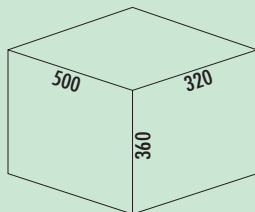

Cox[®] Base 360 K/500-2

- With pull-out complete lid.
- guide rail depth 470 mm
 - waste capacity 27.5 (1 x 15.5/1 x 12) liters
 - technology: full pull-out
 - fitting: cabinet wall and front panel
 - **with soft retraction and damping**
 - **installation depth 320 mm**

8012400	without bio lid, light grey, H 360 mm	€ 331.24
8013400	without bio lid, anthracite, H 360 mm	€ 331.24
8012401	with bio lid, light grey, H 360 mm	€ 341.39
8013401	with bio lid, anthracite, H 360 mm	€ 341.39

Optional accessories

8012343	Bio-lid, light grey, for 7.5/ 9/ 12 liters	€ 17.12
8013343	Bio-lid, anthracite, for 7.5/ 9/ 12 liters	€ 17.12
8012367	Cox Cick [®] , dark grey/chrome matt	€ 69.43

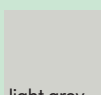
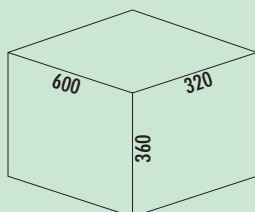

Cox[®] Base 360 K/600-2

- With pull-out complete lid.
- guide rail depth 470 mm
 - waste capacity 31 (2 x 15.5) liters
 - technology: full pull-out
 - fitting: cabinet wall and front panel
 - **with soft retraction and damping**
 - **installation depth 320 mm**

8012402	without bio lid, light grey, H 360 mm	€ 339.66
8013402	without bio lid, anthracite, H 360 mm	€ 339.66
8012403	with bio lid, light grey, H 360 mm	€ 350.07
8013403	with bio lid, anthracite, H 360 mm	€ 350.07

Optional accessories

8012344	Bio lid, light grey, for 10/ 12/ 15.5 liters	€ 17.56
8013344	Bio lid, anthracite, for 10/ 12/ 15.5 liters	€ 17.56
8012369	Cox Cick-E [®] 600 K, dark grey/chrome matt	€ 493.51
8012367	Cox Cick [®] , dark grey/chrome matt	€ 69.43

SELECTAkit® Pull-out technology for front pull-out

Order no. Description

per piece excl. VAT

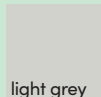
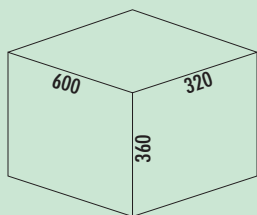

light grey

anthracite

Cox® Base 360 K/600-3

- With pull-out complete lid.
- guide rail depth 470 mm
 - waste capacity 30,5 (1 x 15,5/2 x 7,5) liters
 - technology: full pull-out
 - fitting: cabinet wall and front panel
 - **with soft retraction and damping**
 - **installation depth 320 mm**

8012489 without bio lid, light grey, H 360 mm € 339.66

8013489 without bio lid, anthracite, H 360 mm € 339.66

8012509 with bio lid, light grey, H 360 mm € 349.65

8013509 with bio lid, anthracite, H 360 mm € 349.65

Optional accessories

8012497 Bio lid, light grey, for 7.5 litres € 17.12

8013497 Bio lid, anthracite, for 7.5 liters € 17.12

8012369 Cox Cick-E® 600 K, dark grey/chrome matt € 493.51

Waste collectors

SELECTAkIt® Pull-out technology for front pull-out

Order no. Description

per piece excl. VAT

Waste collectors



Cox Base-Board®

Cox Base Board® is a perfect supplement to the Cox® Base waste collector, convincing due to high quality, convenient handling and perfect pull-out technology:

- H 100 mm
- **depth of the guide rail 470 mm**
- GRASS self-retracting full pull-out technology with Airmatic soft-impact, proven in long-term tests
- smooth operation and lateral stability even under full load
- stable metal frame, powder-coated
- optimal utilisation of space of storage boxes by flexible positioning of the boxes by means of separate brackets
- available for cupboard widths 500, 600 and 900 mm
- exactly fitting assembly using the "quick & easy" assembly plate, also suitable for the retrofitting of existing Cox® Base waste collectors

Cox Base-Board® – competitive edge due to perfectly attenuated pull-out technology!

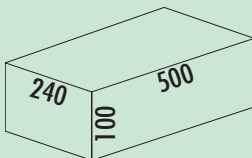

Cox Base-Board® 500

- height 100 mm
- guide rail depth 470 mm
- uniform design to Cox® Base
- technology: full pull-out
- fitting: cabinet wall
- **with soft retraction and damping**
- **boîtes de rangement 1 x 2.7 l et 1 x 1.2 l et 4 fixations incluses**

8012360 silver € 232.67

8013360 anthracite € 232.67

Optional accessories

8012362 Storage box, dark grey, 2.7 liters € 14.48

8013362 Storage box, anthracite, 2.7 liters € 14.48

8012363 Storage box, dark grey, 1.2 liters € 12.02

8013363 Storage box, anthracite, 1.2 liters € 12.02

8012364 Bracket for storage box, silver € 2.19

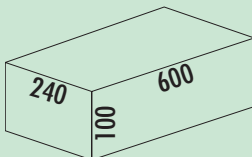

Cox Base-Board® 600

- height 100 mm
- guide rail depth 470 mm
- uniform design to Cox® Base
- technology: full pull-out
- fitting: cabinet wall
- **with soft retraction and damping**
- **1 x 2.7 l and 1 x 1.2 l storage boxes and 4 brackets included**

8012361 silver € 232.67

8013361 anthracite € 232.67

Optional accessories

8012362 Storage box, dark grey, 2.7 liters € 14.48

8013362 Storage box, anthracite, 2.7 liters € 14.48

8012363 Storage box, dark grey, 1.2 liters € 12.02

8013363 Storage box, anthracite, 1.2 liters € 12.02

8012364 Bracket for storage box, silver € 2.19



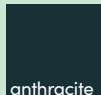
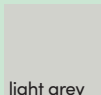
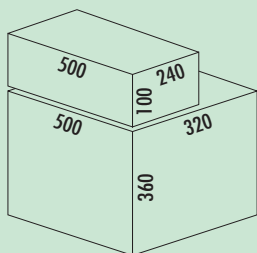
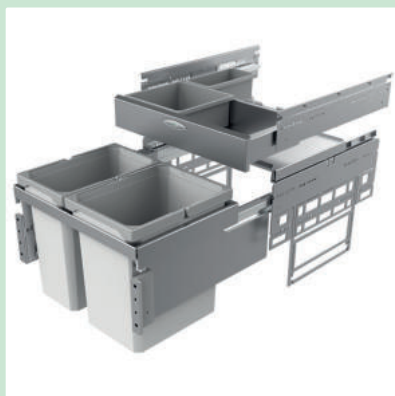

Cox® Base 360 K/500-2 with Base-Board

- guide rail depth 470 mm
- waste capacity 27.5 (1 x 15.5/1 x 12) liters
- technology: full pull-out
- fitting: cabinet wall and front panel
- **with soft retraction and damping**
- **installation depth 320 mm**
- **1 x 2.7 l and 1 x 1.2 l storage boxes and 4 brackets included**

8012800	without bio lid, light grey, H 460 mm	€ 528.66
8013800	without bio lid, anthracite, H 460 mm	€ 528.66
8012801	with bio lid, light grey, H 460 mm	€ 538.89
8013801	with bio lid, anthracite, H 460 mm	€ 538.89

Optional accessories

8012343	Bio-lid, light grey, for 7.5/ 9/ 12 liters	€ 17.12
8013343	Bio-lid, anthracite, for 7.5/ 9/ 12 liters	€ 17.12

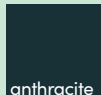
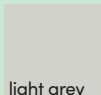
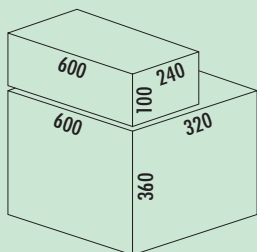

Cox® Base 360 K/600-2 with Base-Board

- guide rail depth 470 mm
- waste capacity 31 (2 x 15.5) liters
- technology: full pull-out
- fitting: cabinet wall and front panel
- **with soft retraction and damping**
- **installation depth 320 mm**
- **1x2.7 l and 1x1.2 l storage boxes and 4 brackets included**

8012802	without bio lid, light grey, H 460 mm	€ 548.01
8013802	without bio lid, anthracite, H 460 mm	€ 548.01
8012803	with bio lid, light grey, H 460 mm	€ 560.39
8013803	with bio lid, anthracite, H 460 mm	€ 560.39

Optional accessories

8012344	Bio lid, light grey, for 10/ 12/ 15.5 liters	€ 17.56
8013344	Bio lid, anthracite, for 10/ 12/ 15.5 liters	€ 17.56
8012369	Cox Cick-E® 600 K, dark grey/chrome matt	€ 493.51



Cox Cick-E® 600 K



- **electric ejector for Cox® waste collectors**
- suitable for Cox® Base waste collector with reduced installation depth (320 mm) and 600 mm width
- space-saving and invisible installation behind the waste collectors
- activation of pull-out mechanism by gently touching the pull-out front
- alternative mounting positions to avoid obstacles on site (e.g. water connection)
- attachment of the crossbar to existing holes of the Cox® waste collector
- 230 V electrical connection
- compatible waste collectors: 8012402, 8013402, 8012403, 8013403, 8012489, 8013489, 8012509, 8013509, 8012802, 8013802, 8012803, 8013803

8012369	dark grey/chrome matt	€ 493.51
----------------	-----------------------	----------

SELECTAkIt® Pull-out technology for front pull-out

Order no. Description

per piece excl. VAT

Waste collectors

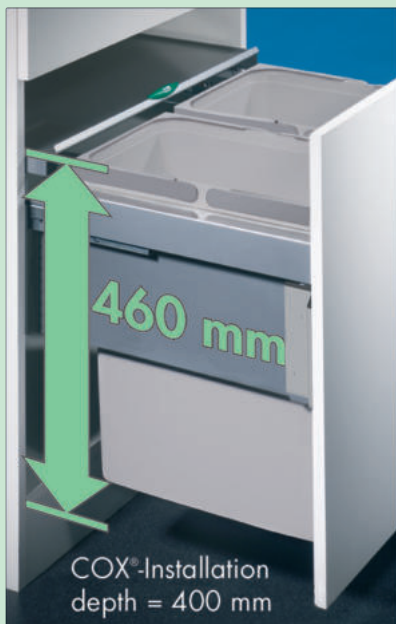

Cox® Base 460 S

- Waste collector as front pull-out system with soft retraction and damping.
- installation height 460 cm
- installation depth 400 cm
- **depth of the installation frame 470 mm**
- "quick&easy"-installation frame for different body thicknesses (16/19 mm)
- "nova Pro" guide rail
- functional design

Container fitting system/litres				
Cabinet body	400	450	500	600
	28		21 28	28 28
	12.5 12.5	21 21	21 12.5 12.5	12.5 28 12.5

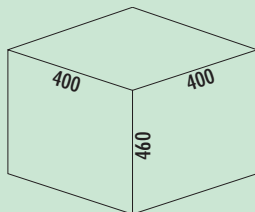

Cox® Base 460 S/400-1

- With pull-out complete lid.
- guide rail depth 470 mm
- waste capacity 28 liters
- technology: full pull-out
- frame/guide silver
- complete lid silver
- fitting: cabinet wall and front panel
- **with soft retraction and damping**

8012311 light grey, H 460 mm

€ 353.71

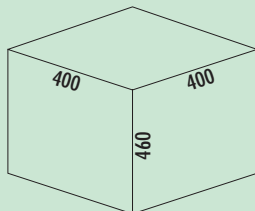

Cox® Base 460 S/400-2

- With pull-out complete lid.
- guide rail depth 470 mm
- waste capacity 25 (2 x 12.5) liters
- technology: full pull-out
- frame/guide silver
- complete lid silver
- fitting: cabinet wall and front panel
- **with soft retraction and damping**

8012356 light grey, H 460 mm

€ 355.63

SELECTAkitt[®] Pull-out technology for front pull-out

Order no. Description

per piece excl. VAT

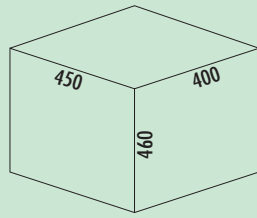

Cox[®] Base 460 S/450-2

- With pull-out complete lid.
- guide rail depth 470 mm
 - waste capacity 42 (2 x 21) liters
 - technology: full pull-out
 - frame/guide silver
 - complete lid silver
 - fitting: cabinet wall and front panel
 - **with soft retraction and damping**

8012306 light grey, H 460 mm

€ 356.51

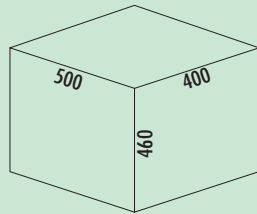

Cox[®] Base 460 S/500-2

- With pull-out complete lid.
- guide rail depth 470 mm
 - waste capacity 49 (1 x 21/1 x 28) liters
 - technology: full pull-out
 - frame/guide silver
 - complete lid silver
 - fitting: cabinet wall and front panel
 - **with soft retraction and damping**

8012307 light grey, H 460 mm

€ 364.06

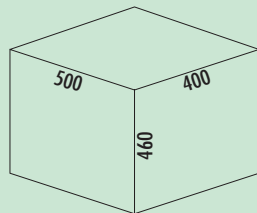

Cox[®] Base 460 S/500-3

- With pull-out complete lid.
- guide rail depth 470 mm
 - waste capacity 46 (1 x 21/2 x 12.5) liters
 - technology: full pull-out
 - frame/guide silver
 - complete lid silver
 - fitting: cabinet wall and front panel
 - **with soft retraction and damping**

8012355 light grey, H 460 mm

€ 374.32

SELECTAkitt[®] Pull-out technology for front pull-out

Order no. Description

per piece excl. VAT

Waste collectors

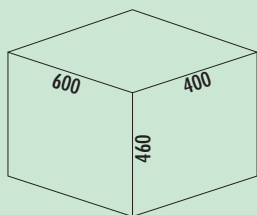

Cox[®] Base 460 S/600-2

- With pull-out complete lid.
- guide rail depth 470 mm
 - waste capacity 56 (2 x 28) liters
 - technology: full pull-out
 - frame/guide silver
 - complete lid silver
 - fitting: cabinet wall and front panel
 - **with soft retraction and damping**

8012308	light grey, H 460 mm	€ 362.12
8013308	anthracite, H 460 mm	€ 362.12

Optional accessories

8012368	Cox Cick-E [®] 600, W 600 mm, dark grey/chrome matt	€ 490.71
---------	--	----------

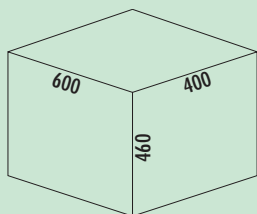

Cox[®] Base 460 S/600-3

- With pull-out complete lid.
- guide rail depth 470 mm
 - waste capacity 53 (1 x 28/2 x 12.5) liters
 - technology: full pull-out
 - frame/guide silver
 - complete lid silver
 - fitting: cabinet wall and front panel
 - **with soft retraction and damping**

8012354	light grey, H 460 mm	€ 372.48
8013354	anthracite, H 460 mm	€ 372.48

Optional accessories

8012368	Cox Cick-E [®] 600, W 600 mm, dark grey/chrome matt	€ 490.71
---------	--	----------

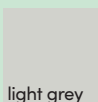

Cox[®] Base single bucket

- Optional accessories for all waste collectors of the group pull-out technology with front pull-out.
- waste capacity 4 liters
 - 144 x 230 x 191 mm (H x W x D)

8012309	light grey	€ 20.72
8013309	anthracite	€ 20.72

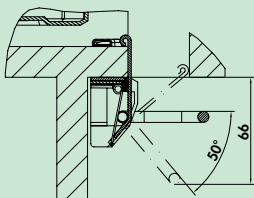

Cox Cick®

Cox Cick® is a manual foot pedal that enables effortless access to the Cox® Base and Cox Clan® waste collectors. Thanks to the ergonomically pleasantly designed pedal position, the waste system opens completely with little force. After operation, the opening mechanism automatically returns to its original position with the aid of a spring. In this way, near-silent operation is guaranteed when opening and closing. The assembly is simple and quick due to two moulded lugs with position fixing. The necessary drilling points are easily found by means of a plastic assembly aid.

- bracket projection on 16 gauge front 34 mm
- bracket projection on 19 gauge front 31 mm

8012367 dark grey/chrome matt

€ 69.43



Bio-lid

Includes 4 activated carbon filters (assumed annual requirement) as retrofitting set for Cox® Base replacement bucket 4, 6, 7, 10 and 12.5 liters.

8013312 anthracite, for 4/ 6/ 7/ 10/ 12.5 liters

€ 15.45

8011312 light grey, for 4/ 6/ 7/ 10/ 12.5 liters

€ 15.45

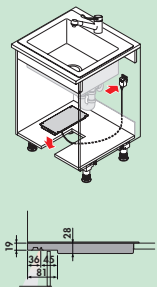

LED foot kick Libero 3.0 with voice control

Motor-controlled ejector for all pull-outs with front extension.

Compatible with Alexa (Amazon) voice control systems. Installation in the front area of the bottom of the cupboard.

Required base recess from cabinet edge: ca. 50 mm, **base height min.**

100 mm

Power supply: up to 230 volts, conventional sockets with 2000 mm cable USB-C/USB plug, drip-proof according to IP21.

- simple operation by foot sensor and/or voice control
- for base units from 300–1200 mm wide
- integrated LED indicator lighting, dimmable, can be switched off
- ejector strength adjustable, sensor sensitivity adjustable
- intelligent control, detects obstacles thanks to sliding clutch
- **product dimensions: 33 x 157 x 300 mm (H x W x D)**
- **cut-out dimensions: 127 x 286 mm (W x D)**

Setting and configuration via web browser.

8011212 white

€ 409.44

SELECTAkit®

Pull-out technology for front pull-out

Pullboy Soft Comfort®



Convincing benefits at a glance

The side-wall mounted waste collector is the ultimate in waste collection convenience:

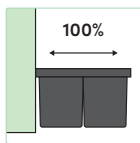

with full pull-out, incl. pull-out protection

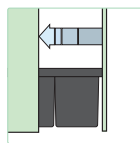

with soft retraction for gentle closing

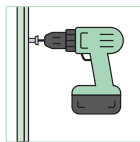

side-wall mounting

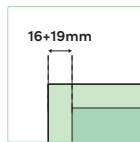

suitable for 16 and 19 mm side walls

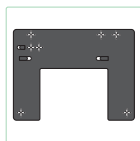

The assembly is very simple using a Comfort Plus metal-installation-template.

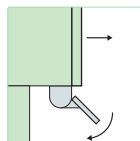

optional pedal for pull-outs with self-retracting and damping

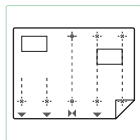

The front assembly is easily carried out with the help of a paper template.

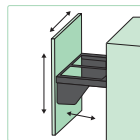

3D tilt adjustment

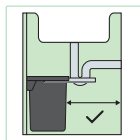

With a low frame depth of just 330 mm (rails 435 mm), there is still enough space for a siphon in the sink cabinet or other under-sink appliances.



With a single lid or alternatively with a lid pull-out system, which includes an anti-slip mat.

Divisions

Pullboy Soft Comfort® 335 K
with fixed lid, installation depth 330 mm

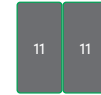

335 K/450-2



335 K/500-2



335 K/600-2



335 K/600-3

Pullboy Soft Comfort® 495 K
with fixed lid, installation depth 330 mm

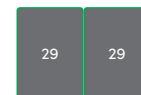

495 K/600-2

Pullboy Soft Comfort® 360 K
with lid pull-out system, installation depth 330 mm



360 K/450-2

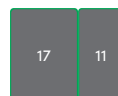

360 K/500-2



335 K/600-2

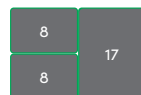

360 K/600-3



Pullboy Soft Comfort®

Waste collector as a front pull-out system with soft-closing mechanism and pull-out locking pins. Available with a fixed lid or with a pull-out lid system incl. anti-slip mat.

- full pull-out runners with self-closing mechanism + damper incl. pull-out safety lock, 30 kg load capacity, LGA tested
- due to its low depth of 330 mm, it still leaves enough space in the sink base unit for a siphon and other under-sink appliances
- the installation is very simple using the **Comfort Plus metal installation template**
- 3D positioning makes subsequent adjustment quick and easy

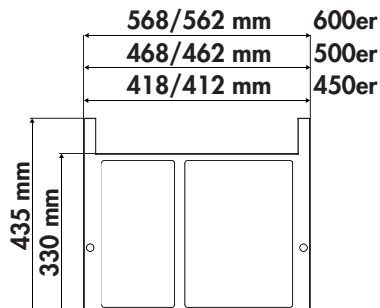

Waste collectors

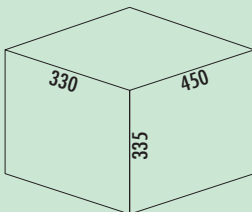

Pullboy Soft Comfort® 335 K/450-2

With a fixed lid. Incl. pull-out locking pins.

- waste volume 22 (2 x 11) litres
- dimensions: 335 x 412 x 330 mm (H x W x D)
- installation: side wall mounting with front panel
- waste system with soft retraction and damping
- for 16/19 mm side walls



8011122 anthracite

€ 264.41

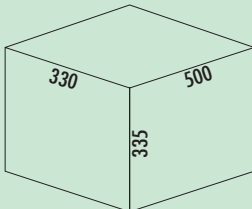

Pullboy Soft Comfort® 335 K/500-2

With a fixed lid. Incl. pull-out locking pins.

- waste system with soft retraction and damping
- waste volume 28 (17 + 11) litres
- dimensions: 335 x 462 x 330 mm (H x W x D)
- installation: side wall mounting with front panel
- for 16/19 mm side walls



8011123 anthracite

€ 269.53

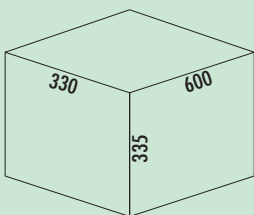

Pullboy Soft Comfort® 335 K/600-3

- With a fixed lid. Incl. pull-out locking pins.
- waste system with soft retraction and damping
 - waste volume 33 (2 x 8/1 x 17) litres
 - dimensions: 335 x 562 x 330 mm (H x W x D)
 - installation: side wall mounting with front panel
 - for 16/19 mm side walls

8011124 anthracite

€ 271.51

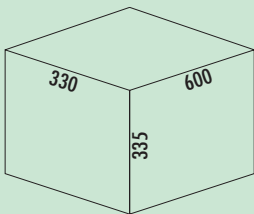

Pullboy Soft Comfort® 335 K/600-2

- With a fixed lid. Incl. pull-out locking pins.
- waste system with soft retraction and damping
 - waste volume 34 (2 x 17) litres
 - dimensions: 335 x 562 x 330 mm (H x W x D)
 - installation: side wall mounting with front panel
 - for 16/19 mm side walls

8011125 anthracite

€ 268.98

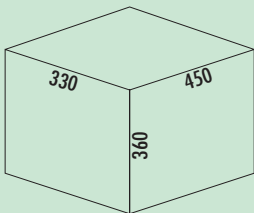

Pullboy Soft Comfort® 360 K/450-2

- With lid pull-out system and pull-out locking pins. Incl. anti-slip mat.
- waste system with soft retraction and damping
 - waste volume 22 (2 x 11) litres
 - dimensions: 360 x 412 x 330 mm (H x W x D)
 - installation: side wall mounting with front panel
 - for 16/19 mm side wall

8011126 anthracite

€ 283.17

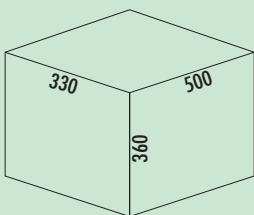

Pullboy Soft Comfort® 360 K/500-2

With lid pull-out system and pull-out locking pins. Incl. anti-slip mat.

- waste system with soft retraction and damping
- waste volume 28 (17 + 11) litres
- dimensions: 360 x 462 x 330 mm (H x W x D)
- installation: side wall mounting with front panel
- for 16/19 mm side walls

8011127 anthracite

€ 286.59

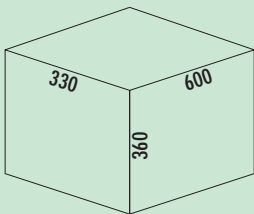

Pullboy Soft Comfort® 360 K/600-3

With lid pull-out system and pull-out locking pins. Incl. anti-slip mat.

- waste system with soft retraction and damping
- waste volume 33 (2 x 8/1 x 17) litres
- dimensions: 360 x 562 x 330 mm (H x W x D)
- installation: side wall mounting with front panel
- for 16/19 mm side walls

8011128 anthracite

€ 302.79

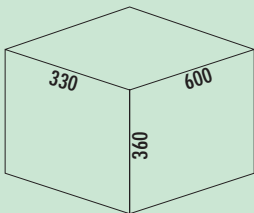

Pullboy Soft Comfort® 360 K/600-2

With lid pull-out system and pull-out locking pins. Incl. anti-slip mat.

- waste system with soft retraction and damping
- waste volume 34 (2 x 17) litres
- dimensions: 562 x 360 x 330 mm (H x W x D)
- installation: side wall mounting with front panel
- for 16/19 mm side walls

8011129 anthracite

€ 296.83

Waste collectors

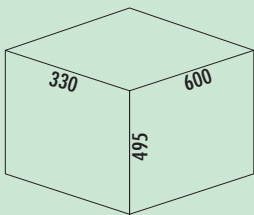

Pullboy Soft Comfort® 495 K/600-2

With a fixed lid. Incl. pull-out locking pins.

- waste system with soft retraction and damping
- waste volume 58 (2 x 29) litres
- dimensions: 495 x 562 x 330 mm (H x W x D)
- installation: side wall mounting with front panel
- for 16/19 mm side walls

Waste
collectors



8011488 anthracite

€ 303.65



Pullboy Soft Fusion®

The Pullboy Soft Comfort Fusion system is ideally suited for the joint installation of a water conditioning device with a total width of 240 mm and a corresponding waste collection system. The perfectly coordinated modules provide for the space-saving arrangement of all the necessary components in a **600 mm wide** sink base unit.

The installation is completed in just a few steps. And it can be flexibly adapted to the given installation situation. In the rear area there is sufficient space for water connections as well as hose and cable routing.

The reservoirs need to be positioned on the left.

Container fitting system/litres	
Cabinet body	600
	17
	8 8
	29

Waste collectors

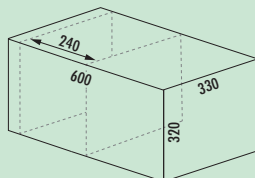

Pullboy Soft Fusion® 320 K/600-1

- waste system with soft closing and damping
- waste volume 17 (1 x 17) litres
- incl. single lid
- dimensions: 320 x 562 x 330 mm (H x W x D)
- installation: side wall mounting with front panel
- for 16/19 mm side walls
- **suitable for a reservoir with a width of 240 mm**



8011732 anthracite, installation on the right

€ 287.44

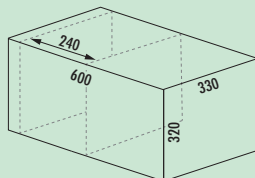

Pullboy Soft Fusion® 320 K/600-2

- waste system with soft closing and damping
- waste volume 16 (2 x 8) litres
- incl. single lid
- dimensions: 320 x 562 x 330 mm (H x W x D)
- installation: side wall mounting with front panel
- for 16/19 mm side walls
- **suitable for a reservoir with a width of 240 mm**



8011733 anthracite, installation on the right

€ 298.53

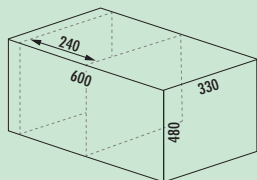

Pullboy Soft Fusion® 480 K/600-1

- waste system with soft closing and damping
- waste volume 29 (1 x 29) litres
- incl. single lid
- dimensions: 480 x 562 x 330 mm (H x W x D)
- installation: side wall mounting with front panel
- for 16/19 mm side walls
- suitable for a reservoir with a width of 240 mm

8011734 anthracite, installation on the right € 330.94

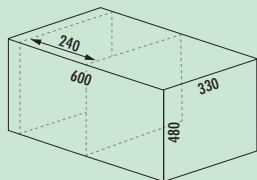

Pullboy Soft Fusion® lid system

- Lid system for Pullboy Soft Fusion®.
- dimensions: 283 x 335 mm (W x D)
 - with anti-slip mat

8011798 anthracite, H 342 mm € 72.69

8011799 anthracite, H 492 mm € 74.71

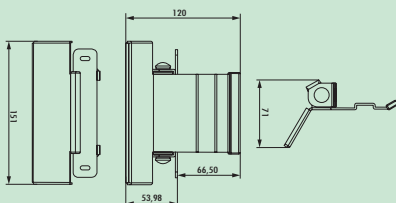

Pedal

- Retrofittable for all self-retracting waste collectors with dampers.
- min. 90 mm base height
 - min. 60 mm gap between cupboard bottom and insert or pull-out

Accessoires suitable for all waste collectors in the range pull-out technology with front pull-out.

8011187 stainless steel € 49.72



Cox® Base 360 R

- Waste collector as front pull-out system with soft retraction and damping.
- installation height 360 mm
- installation depth 400 mm
- **depth of the guide rail 470 mm**
- "quick&easy" installation frame for various cabinet thicknesses (16/19 mm)
- "nova Pro" guide rail
- functional design
- **with top frame for several bags**

Top frame with clamping hook for Cox® base 360 R:

Cox® top frame with clamping hook

As a practical accessory for the large-volume waste container the optional two-piece top frame makes it possible to conveniently insert rubbish bags of various sizes into the plastic containers. Individual and practical for every requirement.

Cox® top frame for bag attachment

The innovative two-piece clamping frame system enables the use of different sizes of rubbish bag. Depending on your preferences, two small or one large bag can be clamped in.

Mounting in a jiffy

Clip the two halves of the top frame onto the top edge of the waste collector. After inserting the rubbish bag into the container, the rubbish bag is pulled down through the support frame and fastened on the outside with the corresponding clamping hooks. Finished!

Especially for Swiss garbage bags

The Cox® Base 460 R waste container with top frame is ideally suited for standard Swiss garbage bags with 35 litres.

Container fitting system/litres		
Cabinet body	500	600
	29	16 29

Waste collectors

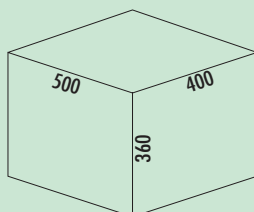

Cox® Base 360 R/500-1

- With pull-out complete lid.
- guide rail depth 470 mm
- waste capacity 29 liters
- technology: full pull-out
- frame/guide silver
- complete lid silver
- fitting: cabinet wall and front panel
- **incl. top frame for bag attachment**
- **with soft retraction and damping**



SELECTAktit® Pull-out technology for front pull-out

Order no. Description

per piece excl. VAT

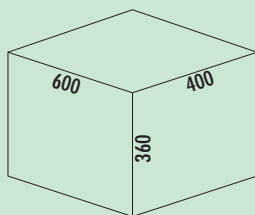

Cox® Base 360 R/600-2

- With pull-out complete lid.
- guide rail depth 470 mm
 - waste capacity 45 (1 x 29/1 x 16) liters
 - technology: full pull-out
 - frame/guide silver
 - complete lid silver
 - fitting: cabinet wall and front panel
 - **incl. top frame for bag attachment**
 - **with soft retraction and damping**

Waste collectors

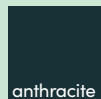
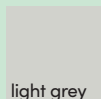

light grey

anthracite

8012406 light grey, H 360 mm € 394.07

8013406 anthracite, H 360 mm € 394.07

Optional accessories

8012368 Cox Cick-E® 600, W 600 mm, dark grey/chrome matt € 490.71

8012367 Cox Cick®, dark grey/chrome matt € 69.43



Cox® Base 460 R

- Waste collector as front pull-out system with soft retraction and damping.
- installation height 460 mm
- installation depth 400 mm
- **depth of the guide rail 470 mm**
- "quick&easy" installation frame for various cabinet thicknesses (16/19 mm)
- "nova Pro" guide rail
- functional design
- **39 litre bucket ideal for Swiss bags (bin bags)**
- **with insertion frame for several bags**

Container fitting system/litres				
Cabinet body	400	450	500	600
	39	39	39	21 39

Waste collectors

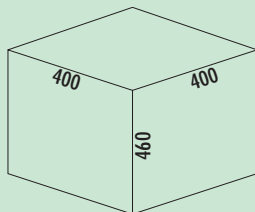

Cox® Base 460 R/400-1

- With pull-out complete lid.
- guide rail depth 470 mm
- waste capacity 39 liters
- technology: full pull-out
- frame/guide silver
- complete lid silver
- fitting: cabinet wall and front panel
- **incl. top frame for bag attachment**
- **with soft retraction and damping**



8012443 light grey, H 460 mm € 359.32

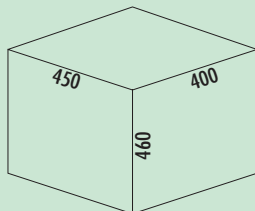

Cox® Base 460 R/450-1

- With pull-out complete lid.
- guide rail depth 470 mm
- waste capacity 39 liters
- technology: full pull-out
- frame/guide silver
- complete lid silver
- fitting: cabinet wall and front panel
- **incl. top frame for bag attachment**
- **with soft retraction and damping**



8012444 light grey, H 460 mm € 359.32

SELECTAkIt® Pull-out technology for front pull-out

Order no. Description

per piece excl. VAT

Waste collectors

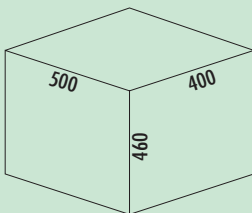

Cox® Base 460 R/500-1

- With pull-out complete lid.
- guide rail depth 470 mm
- waste capacity 39 liters
- technology: full pull-out
- frame/guide silver
- complete lid silver
- fitting: cabinet wall and front panel
- **incl. top frame for bag attachment**
- **with soft retraction and damping**

8012445 light grey, H 460 mm € 359.32

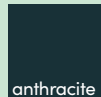
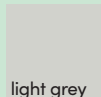
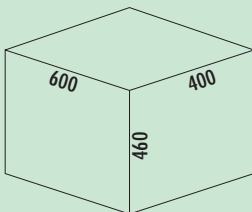

Cox® Base 460 R/600-2

- With pull-out complete lid.
- guide rail depth 470 mm
- waste capacity 60 (1 x 39/1 x 21) liters
- technology: full pull-out
- frame/guide silver
- complete lid silver
- fitting: cabinet wall and front panel
- **incl. top frame for bag attachment**
- **with soft retraction and damping**

8012446 light grey, H 460 mm € 405.31

8013446 anthracite, H 460 mm € 405.31

Optional accessories

8012368 Cox Cick-E® 600, W 600 mm, dark grey/chrome matt € 490.71

SELECTAkit®

Pull-out technology for front pull-out

Cox Clan® – Waste collectors for large waste volume

The sophisticated waste collector Cox Clan® is the continuation of the success story of the Cox® system series. As the "big brother" of the Cox® Base systems, it is ideally suited for holding high volumes of waste.

- GRASS full pull-out and over-extension technology with self-retraction and Air-matic soft-impact, proven in long-term tests
- smooth operation and lateral stability even under full load
- reinforced metal housing frame for container holder, powder-coated
- equipped with metal lid, powder-coated
- suitable for 16 mm and 19 mm side thicknesses
- available for five cupboard widths and in various heights
- installation depth amounts to 516 mm



Waste
collectors

Cox Clan® convinces due to easy assembly:



1. Transfer the mounting points in the body using the template.



2. Mount the pull-out rails and locating pins for the depositing lid.



3. Place the depositing lid on the pins and hook the pull-out frame into the pull-out rails.



4. Mount the front attachment using the template.



5. Hang the front plate into the pull-out frame and fasten it, then clip on the plastic covers.



6. Insert containers. Finished!

SELECTAkIt® Pull-out technology for front pull-out

Order no. Description

per piece excl. VAT

Waste collectors

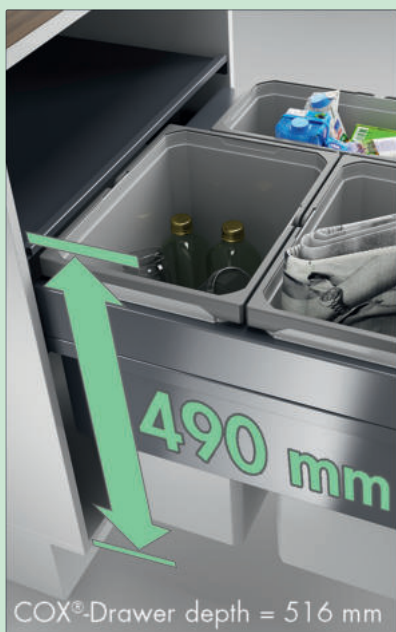

Cox Clan® 490

Waste collector front pull-out system for large waste capacity with soft retraction and impact attenuation.

- installation height 490 mm
- installation depth 516 mm
- **depth of the installation frame 510 mm**
- "quick&easy" installation frame for different body thicknesses (16/19 mm)
- "nova Pro" guide rail
- functional design

Container fitting system/litres				
Cabinetbody	450	500	600	
	29.5	29.5	29.5	21
	29.5	29.5	29.5	

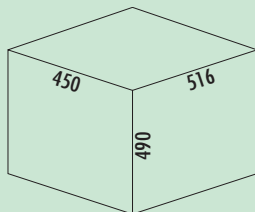

Cox Clan® 490/450-2

- guide rail depth 510 mm
- waste capacity 59 (2 x 29.5) liters
- technology: over extension
- frame/guide silver
- complete lid silver
- fitting: cabinet wall and front panel
- **with soft retraction and damping**

8012381 light grey, H 490 mm

€ 426.90

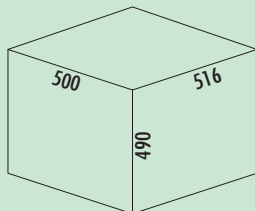

Cox Clan® 490/500-2

- guide rail depth 510 mm
- waste capacity 59 (2 x 29.5) liters
- technology: over extension
- frame/guide silver
- complete lid silver
- fitting: cabinet wall and front panel
- **with soft retraction and damping**

8012382 light grey, H 490 mm

€ 429.71

SELECTAkit® Pull-out technology for front pull-out

Order no. Description

per piece excl. VAT

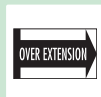
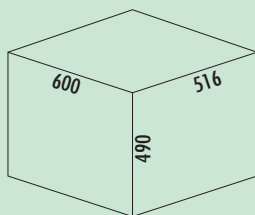

Cox Clan® 490/600-3

- guide rail depth 510 mm
- waste capacity 80 (2 x 29.5/1 x 21) liters
- technology: over extension
- frame/guide silver
- complete lid silver
- fitting: cabinet wall and front panel
- **with soft retraction and damping**

8012384 light grey, H 490 mm

€ 473.76

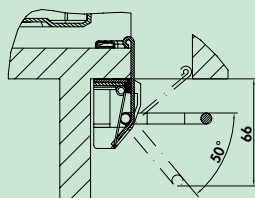

Cox Cick®

Cox Cick® is a manual foot pedal that enables effortless access to the Cox® Base and Cox Clan® waste collectors. Thanks to the ergonomically pleasantly designed pedal position, the waste system opens completely with little force. After operation, the opening mechanism automatically returns to its original position with the aid of a spring. In this way, near-silent operation is guaranteed when opening and closing. The assembly is simple and quick due to two moulded lugs with position fixing. The necessary drilling points are easily found by means of a plastic assembly aid.

- bracket projection on 16 gauge front 34 mm
- bracket projection on 19 gauge front 31 mm

8012367 dark grey/chrome matt

€ 69.43

Waste collectors

SELECTAkIt® Pull-out technology for front pull-out

Order no. Description

per piece excl. VAT

Waste collectors

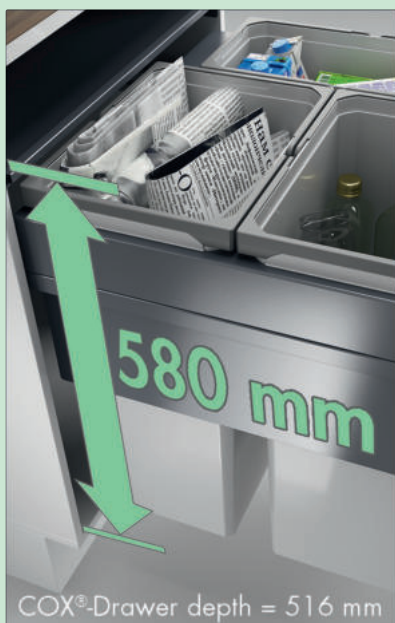

Cox Clan® 580

Waste collector front pull-out system for large waste capacity with soft retraction and impact attenuation.

- installation height 580 mm
- installation depth 516 mm
- **depth of the installation frame 510 mm**
- "quick&easy" installation frame for different body thicknesses (16/19 mm)
- "nova Pro" guide rail
- functional design

Container fitting system/litres						
Cabinet/body	300	400	450	500	600	
	1.2	1.2	35	35	35	21
	32	35	35	35	35	

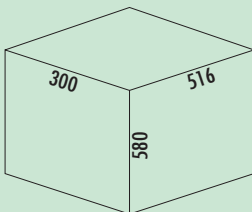

Cox Clan® 580/300-2

- guide rail depth 510 mm
- waste capacity 33.2 (1 x 32/1 x 1.2) liters
- technology: full pull-out
- frame/guide silver
- complete lid silver
- fitting: cabinet wall and front panel
- **with soft retraction and damping**



8012386 light grey, H 580 mm

€ 382.84

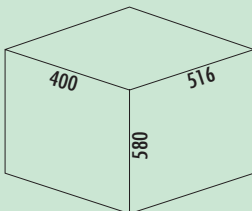

Cox Clan® 580/400-2

- guide rail depth 510 mm
- waste capacity 36.2 (1 x 35/1 x 1.2) liters
- technology: full pull-out
- frame/guide silver
- complete lid silver
- fitting: cabinet wall and front panel
- **with soft retraction and damping**



8012387 light grey, H 580 mm

€ 392.15

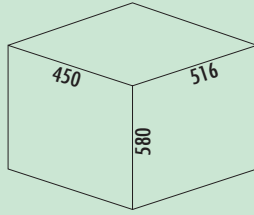

Cox Clan[®] 580/450-2

- guide rail depth 510 mm
- waste capacity 70 (2 x 35) liters
- technology: over extension
- frame/guide silver
- complete lid silver
- fitting: cabinet wall and front panel
- **with soft retraction and damping**

8012388 light grey, H 580 mm

€ 433.49

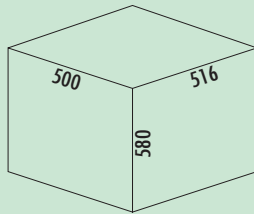

Cox Clan[®] 580/500-2

- guide rail depth 510 mm
- waste capacity 70 (2 x 35) liters
- technology: over extension
- frame/guide silver
- complete lid silver
- fitting: cabinet wall and front panel
- **with soft retraction and damping**

8012389 light grey, H 580 mm

€ 433.49

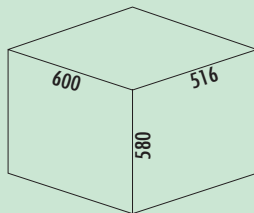











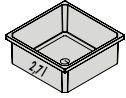

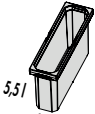

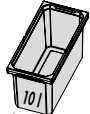

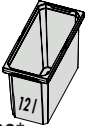
Cox Clan[®] 580/600-3

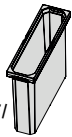
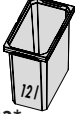
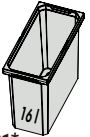
- guide rail depth 510 mm
- waste capacity 91 (2 x 35/1 x 21) liters
- technology: over extension
- frame/guide silver
- complete lid silver
- fitting: cabinet wall and front panel
- **with soft retraction and damping**

8012391 light grey, H 580 mm











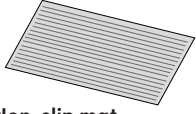

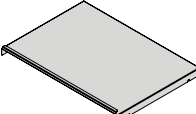





€ 487.90

Replacement bucket and lid overview for Cox® series

Width mm	102	113	183	183	204	230			
Depth mm	204	382	302	382	204	191			
	Order no.	€ per pc. excl. VAT	Order no.	€ per pc. excl. VAT	Order no.	€ per pc. excl. VAT			
Height mm	82	 8013363* 8012363	12,02			 8013362* 8012362	14,48		
	144					 8013309* 8012309	20,72		
	216		 8013325* 8012325	26,68	 8013327* 8012327	31,77	 8013329* 8012329	34,23	
	256			 8012493	33,71	 8013492* 8012492	38,97	 8013491* 8012491	29,31
	326	 8012332	33,01	 8013333* 8012333	39,23	 8013321* 8012321	42,04	 8013320* 8012320	34,32
	426					 8013323* 8012323	46,78	 8013319* 8012319	39,15
	460								
	550								
Cealing lid			 8013339* 8012339	9,12	 8013341* 8012341	9,12	 8013338* 8012338	6,23	
Bill lid			 8013343* 8012343	17,12			 8013312* 8011312	15,45	

*anthracite

Replacement bucket and lid overview for Cox® series

Width mm	230	230	230	230	250	315	Accessories
Depth mm	302	151	340	382	340	382	
	Order no. € per pc. excl. VTA	Order no. € per pc. excl. VTA	Order no. € per pc. excl. VTA	Order no. € per pc. excl. VTA	Order no. € per pc. excl. VTA	Order no. € per pc. excl. VTA	Order no. € per pc. excl. VAT
Height mm	82						 Non-slip mat up to 600 mm 8013352* 12.46 8012352
	144						up to 1200 mm 8013353* 24.76 8012353
	216	 8012328 34.66			 8013330* 8012330 40.20		 Complete lid Width 400 mm 8013153* 83.29 8010153
	256	 8012494 38.97			 8013490* 8012490 42.65		Width 450 mm 8013154* 89.61 8010154
	326	 8013334* 8012334 41.42	 8013495* 8012495 30.90		 8013322* 8012322 48.62		Width 500 mm 8013145* 99.44 8010145
	426				 8013324* 8012324 51.17	 8013335* 8012335 51.96	Width 600 mm 8013146* 103.22 8010146
	460					 8012395 54.33	Width 800 mm 8013356* 76.44 8012347
	550						Width 900 mm 8013357* 81.98 8012348
			 8012398 57.04		 8012397 58.90	Width 1000 mm 8012349 89.26 Width 1200 mm 8012350 97.60	
Sealing lid/top frame	 8012340 9.83			 8013342* 8012342 9.83		 8012337 25.63	Width 500 mm, Depth 320 mm 8013345* 97.60 8012345
Bio lid	 8013344* 8012344 17.56	 8013497* 8012497 17.12					Width 600 mm, Depth 320 mm 8013346* 99.44 8012346
							Width 600 mm, Depth 400 mm 8013351* 72.41 8012351
							Width 300 mm, Depth 516 mm 8010160 77.50

*anthracite

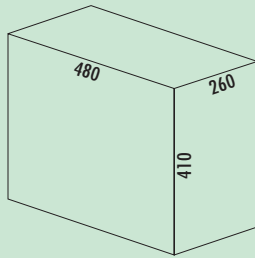

Profiline Double-Boy® 410 S/300-2 with front conn.

- waste capacity 30 (1 x 20/1 x 10) liters
- technology: full pull-out
- fitting: cabinet bottom and front panel

8012093 anthracite

€ 191.43

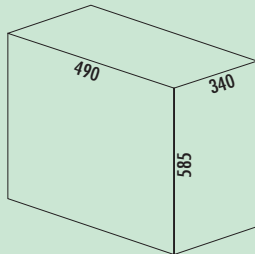

Traditionline Double-Master® 585 S/400-2 with front conn.

- waste capacity 64 (2 x 32) liters
- technology: full pull-out
- fitting: cabinet bottom
- with side wall fastening
- for cabinets up to max. 450 mm

8011464 aluminium grey

€ 235.22

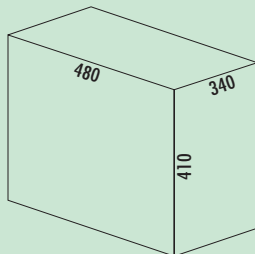

Traditionline Trio-Master® 410 S/400-3 with front conn.

- waste capacity 40 (1 x 20/2 x 10) liters
- technology: full pull-out
- fitting: cabinet bottom
- for cabinets up to max. 450 mm

8011169 aluminium grey

€ 183.43

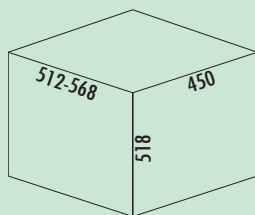

Müllex Boxx 55/60-R Bio

- low-noise, sturdy pull-out system
- waste capacity 47 (41/5/1) liters
- container with round filling of the 35-l bin bag, extended with additional container and bio-bucket 5 l
- optional two 17-l bin bags
- technology: full pull-out
- pull-out cover drawer
- in case of bulky siphon, the rear wall of the drawer can be adjusted
- adapter for 600 mm body supplied
- retraction damping as standard
- guide rail depth 520 mm
- lid anthracite
- fitting: cabinet bottom and front panel
- max. cabinet width 600 mm

8011049 anthracite

€ 561.72

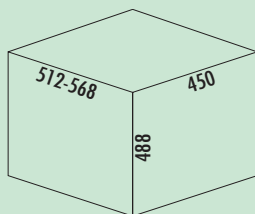

Müllex Euro Boxx 55/60 R

- low-noise, sturdy pull-out system
- waste capacity 56 (1 x 40/1 x 16) liters
- container with round filling of the 35-l bin bag
- optional two 17-l bin bags
- technology: full pull-out
- pull-out cover drawer
- in case of bulky siphon, the rear wall of the drawer can be adjusted
- extended with 16-l additional container
- adapter for 600 mm body supplied
- retraction damping as standard
- guide rail depth 520 mm
- lid anthracite
- fitting: cabinet bottom and front panel
- max. cabinet width 600 mm

8011019 anthracite

€ 530.99



StopMatic

The pull-out systems Müllex Comfort and Müllex Oekonom can be optionally equipped with the StopMatic accessories. A damper with "self-closing function" which can be inserted into the rail profile slows the pull-out just before it reaches the final position.

StopMatic and KickMatic are not combinable.

8011066 light grey

€ 39.05



KickMatic

The pull-out systems Müllex Comfort, Müllex Oekonom and Müllex Boxx can be equipped with the KickMatic accessories on request. Press lightly with your foot and the bucket slides gently out of the bottom cabinet. So you have both hands free.

StopMatic and KickMatic are not combinable.

8011070 chrome

€ 128.14

SELECTAkit®

Pull-out technology for existing pull-outs

The flexible waste system



Waste
collectors

Cox Stand-UP® 250 S	Page 182–185
Cox Stand-UP® 280 S	Page 186–188
Cox Stand-UP® 350 S	Page 189–191
Cox Stand-UP® 350 K	Page 192–193
Tandem 2	Page 193
Pullboy Vario 335 S	Page 195
Pullboy Vario 320 S	Page 195
Pullboy Vario 300 S	Page 196
Pullboy Vario 320 S	Page 196–197
Pullboy Versa® 265 K	Page 199–201
Pullboy Versa® 265 S	Page 202–204
Pullboy® complete lid	Page 204
Cox® Giallo	Page 205
X-LINE	Page 206–207

Suitable for the following front layouts:



Full front Front panel
with one
division Front panel
with one
division Front panel
with two
divisions

Please check the heights of the product groups.

SELECTAkit®

Pull-out technology for existing pull-outs



Cox Stand-UP®

Kitchen base cabinets with front pull-out are available in several widths and various frame and front heights for kitchen planning. Naber provides waste collector combinations that make perfect use of the storage space in a comparable range of sizes.

- The waste system Cox Stand-UP® offers three container heights and can be configured for four different cabinet widths.
- Cox Stand-UP® is quick and easy to install; existing front pull-outs can also be equipped without any problems.

To provide kitchen users with the largest possible container volume, Cox Stand-UP® is highly flexible in design and adapts to any cabinet situation with or without a water connection.

- The complete lid of the system can also be installed behind the top front to save space and thus maximise the total possible volume.
- Note: 350 mm high waste collectors can be safely accommodated behind a 390 mm high cabinet front.

The high-quality containers are securely positioned in a floor-mounted frame. As optional accessories, sealing lids – also in the version for organic waste – make domestic waste and recycling management even easier.



Cox Stand-UP® 250 S



Cox Stand-UP® 280 S



Cox Stand-UP® 350 S



Cox Stand-UP® 350 K



Cox Stand-UP® 250 S

The Cox-Stand-UP® waste system 250 is ideally suited for quick installation on existing pull-outs with a **nominal depth of 450 mm and 500 mm**. The total height of the system is 250 mm, whereby the **clear installation height is only 240 mm**. Depending on the installation situation, the fixed complete lid can also be mounted behind the upper front to save space. The maximum frame height (dimension from the pull-out shelf to the top edge of the frame) is 145 mm.

The Cox-Stand-UP® waste system is available in different heights, cabinet widths and bucket combinations.

Container fitting system/litres			
Cabinet body	600	800	900
	13 13	13 10 13	13 13 13
	13 6 6	13 10 6 6	13 13 6 6

Waste collectors

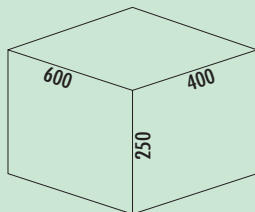

Cox Stand-UP® 250 S/600-2

For mounting on existing pull-outs with a nominal depth of 450 mm and 500 mm.

- maximum frame height (dimension from the bottom of the drawer to the top edge of the frame) 145 mm
- minimum installation depth (internal dimension of the drawer) 400 mm
- waste volume 26 (2 x 13) litres
- total height 250 mm
- installation height without complete lid 240 mm
- complete lid can be mounted behind the upper front to save space
- bucket height 216 mm

8013380 anthracite, H 250 mm € 200.82

Optional accessories

8013342 Closing-lid, anthracite, for 13/ 16/ 22/ 28 liters € 9.83

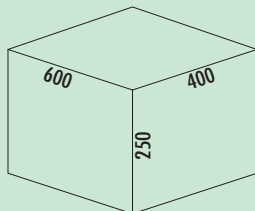

Cox Stand-UP® 250 S/600-3

For mounting on existing pull-outs with a nominal depth of 450 mm and 500 mm.

- maximum frame height (dimension from the bottom of the drawer to the top edge of the frame) 145 mm
- minimum installation depth (internal dimension of the drawer) 400 mm
- waste volume 25 (1 X 13/ 2 x 6) litres
- total height 250 mm
- installation height without complete lid 240 mm
- complete lid can be mounted behind the upper front to save space
- bucket height 216 mm

8013381 without bio lid, anthracite, H 250 mm € 218.63

8013382 with bio lid, anthracite, H 250 mm € 231.16

Optional accessories

8013312 Bio-lid, anthracite, for 4/ 6/ 7/ 10/ 12.5 liters € 15.45

8011178 Bio-filter retrofitting set, black € 7.71

8013342 Closing-lid, anthracite, for 13/ 16/ 22/ 28 liters € 9.83

8013338 Closing-lid, anthracite, for 4/ 6/ 7/ 10/ 12.5 liters € 6.23

SELECTAkit® Pull-out technology for existing pull-outs

Order no. Description

per piece excl. VAT

Waste collectors

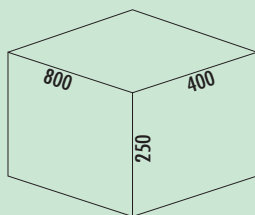

Cox Stand-UP® 250 S/800-3

For mounting on existing pull-outs with a nominal depth of 450 mm and 500 mm.

- maximum frame height (dimension from the bottom of the drawer to the top edge of the frame) 145 mm
- minimum installation depth (internal dimension of the drawer) 400 mm
- waste volume 36 (1 X 10/ 2 x 13) litres
- total height 250 mm
- installation height without complete lid 240 mm
- complete lid can be mounted behind the upper front to save space
- bucket height 216 mm

8013383 anthracite, H 250 mm € 293.67

Optional accessories

8013342 Closing-lid, anthracite, for 13/ 16/ 22/ 28 liters € 9.83

8013341 Closing-lid, anthracite, for 10/ 12/ 16/ 21 liters € 9.12

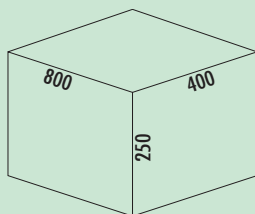

Cox Stand-UP® 250 S/800-4

For mounting on existing pull-outs with a nominal depth of 450 mm and 500 mm.

- maximum frame height (dimension from the bottom of the drawer to the top edge of the frame) 145 mm
- minimum installation depth (internal dimension of the drawer) 400 mm
- waste volume 35 (1 x 13/1 x 10/2 x 6) litres
- total height 250 mm
- installation height without complete lid 240 mm
- complete lid can be mounted behind the upper front to save space
- bucket height 216 mm

8013384 without bio lid, anthracite, H 250 mm € 311.49

8013385 with bio lid, anthracite, H 250 mm € 324.49

Optional accessories

8013312 Bio-lid, anthracite, for 4/ 6/ 7/ 10/ 12.5 liters € 15.45

8011178 Bio-filter retrofitting set, black € 7.71

8013342 Closing-lid, anthracite, for 13/ 16/ 22/ 28 liters € 9.83

8013341 Closing-lid, anthracite, for 10/ 12/ 16/ 21 liters € 9.12

8013338 Closing-lid, anthracite, for 4/ 6/ 7/ 10/ 12.5 liters € 6.23

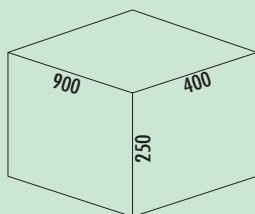

Cox Stand-UP® 250 S/900-3

For mounting on existing pull-outs with a nominal depth of 450 mm and 500 mm.

- maximum frame height (dimension from the bottom of the drawer to the top edge of the frame) 145 mm
- minimum installation depth (internal dimension of the drawer) 400 mm
- waste volume 39 (3 X 13) litres
- total height 250 mm
- installation height without complete lid 240 mm
- complete lid can be mounted behind the upper front to save space
- bucket height 216 mm

8013386 anthracite, H 250 mm € 311.49

Optional accessories

8013342 Closing-lid, anthracite, for 13/ 16/ 22/ 28 liters € 9.83

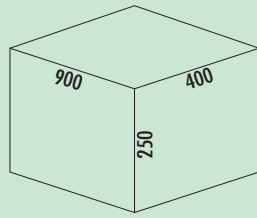

Cox Stand-UP® 250 S/900-4

- For mounting on existing pull-outs with a nominal depth of 450 mm and 500 mm.
- maximum frame height (dimension from the bottom of the drawer to the top edge of the frame) 145 mm
 - minimum installation depth (internal dimension of the drawer) 400 mm
 - waste volume 38 (2 X 13/ 2 x 6) litres
 - total height 250 mm
 - installation height without complete lid 240 mm
 - complete lid can be mounted behind the upper front to save space
 - bucket height 216 mm

8013387	without bio lid, anthracite, H 250 mm	€ 330.27
8013388	with bio lid, anthracite, H 250 mm	€ 343.13

Optional accessories

8013312	Bio-lid, anthracite, for 4/ 6/ 7/ 10/ 12.5 liters	€ 15.45
8011178	Bio-filter retrofitting set, black	€ 7.71
8013342	Closing-lid, anthracite, for 13/ 16/ 22/ 28 liters	€ 9.83
8013338	Closing-lid, anthracite, for 4/ 6/ 7/ 10/ 12.5 liters	€ 6.23

Waste collectors



Cox Stand-UP[®] 280 S

The Cox-Stand-UP waste system 280 is ideally suited for quick installation on existing pull-outs with a **nominal depth of 450 mm and 500 mm**. The total height of the system is 280 mm, whereby the **clear installation height is only 270 mm**. Depending on the installation situation, the fixed complete lid can also be mounted behind the upper front to save space. The maximum frame height (dimension from the pull-out shelf to the top edge of the frame) is 175 mm.

The Cox-Stand-UP waste system is available in different heights, cabinet widths and bucket combinations.

Container fitting system/litres			
Cabinet body	600	800	900
	16 16	16 12 16	16 16 16
	16 7 7	16 12 7 7	16 16 7 7

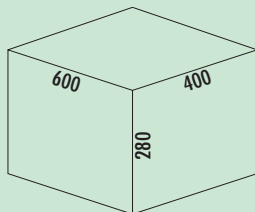

Cox Stand-UP[®] 280 S/600-2

For mounting on existing pull-outs with a nominal depth of 450 mm and 500 mm.

- maximum frame height (dimension from the bottom of the drawer to the top edge of the frame) 175 mm
- minimum installation depth (internal dimension of the drawer) 400 mm
- waste volume 32 (2 X 16) litres
- total height 280 mm
- installation height without complete lid 270 mm
- complete lid can be mounted behind the upper front to save space
- bucket height 256 mm

8013389 anthracite, H 280 mm € 208.27

Optional accessories

8013342 Closing-lid, anthracite, for 13/ 16/ 22/ 28 liters € 9.83

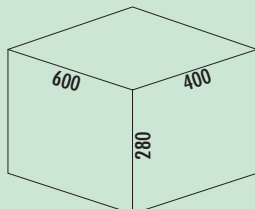

Cox Stand-UP[®] 280 S/600-3

For mounting on existing pull-outs with a nominal depth of 450 mm and 500 mm.

- maximum frame height (dimension from the bottom of the drawer to the top edge of the frame) 175 mm
- minimum installation depth (internal dimension of the drawer) 400 mm
- waste volume 30 (1 X 16/ 2 x 7) litres
- total height 280 mm
- installation height without complete lid 270 mm
- complete lid can be mounted behind the upper front to save space
- bucket height 256 mm

8013390 without bio lid, anthracite, H 280 mm € 222.41

8013391 with bio lid, anthracite, H 280 mm € 234.87

Optional accessories

8013312 Bio-lid, anthracite, for 4/ 6/ 7/ 10/ 12.5 liters € 15.45

8011178 Bio-filter retrofitting set, black € 7.71

8013342 Closing-lid, anthracite, for 13/ 16/ 22/ 28 liters € 9.83

8013338 Closing-lid, anthracite, for 4/ 6/ 7/ 10/ 12.5 liters € 6.23

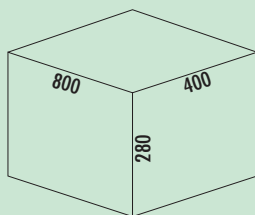

Cox Stand-UP® 280 S/800-3

For mounting on existing pull-outs with a nominal depth of 450 mm and 500 mm.

- maximum frame height (dimension from the bottom of the drawer to the top edge of the frame) 175 mm
- minimum installation depth (internal dimension of the drawer) 400 mm
- waste volume 44(2 X 16/ 1 x 12) litres
- total height 280 mm
- installation height without complete lid 270 mm
- complete lid can be mounted behind the upper front to save space
- bucket height 256 mm

8013393 anthracite, H 280 mm € 303.06

Optional accessories

8013342 Closing-lid, anthracite, for 13/ 16/ 22/ 28 liters € 9.83

8013341 Closing-lid, anthracite, for 10/ 12/ 16/ 21 liters € 9.12

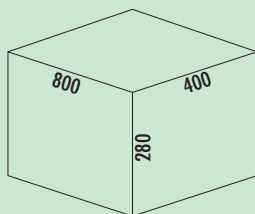

Cox Stand-UP® 280 S/800-4

For mounting on existing pull-outs with a nominal depth of 450 mm and 500 mm.

- maximum frame height (dimension from the bottom of the drawer to the top edge of the frame) 175 mm
- minimum installation depth (internal dimension of the drawer) 400 mm
- waste volume 42 (1 x 16/1 x 12/2 x 7) litres
- total height 280 mm
- installation height without complete lid 270 mm
- complete lid can be mounted behind the upper front to save space
- bucket height 256 mm

8013394 without bio lid, anthracite, H 280 mm € 317.10

8013395 with bio lid, anthracite, H 280 mm € 329.23

Optional accessories

8013312 Bio-lid, anthracite, for 4/ 6/ 7/ 10/ 12.5 liters € 15.45

8011178 Bio-filter retrofitting set, black € 7.71

8013342 Closing-lid, anthracite, for 13/ 16/ 22/ 28 liters € 9.83

8013341 Closing-lid, anthracite, for 10/ 12/ 16/ 21 liters € 9.12

8013338 Closing-lid, anthracite, for 4/ 6/ 7/ 10/ 12.5 liters € 6.23

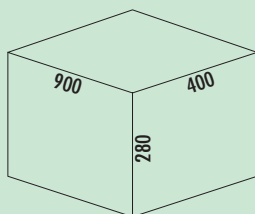

Cox Stand-UP® 280 S/900-3

For mounting on existing pull-outs with a nominal depth of 450 mm and 500 mm.

- maximum frame height (dimension from the bottom of the drawer to the top edge of the frame) 175 mm
- minimum installation depth (internal dimension of the drawer) 400 mm
- waste volume 48 (3 x 16) litres
- total height 280 mm
- installation height without complete lid 270 mm
- complete lid can be mounted behind the upper front to save space
- bucket height 256 mm

8013396 anthracite, H 280 mm € 324.65

Optional accessories

8013342 Closing-lid, anthracite, for 13/ 16/ 22/ 28 liters € 9.83

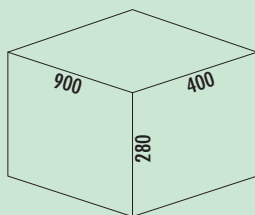

Waste collectors

Cox Stand-UP® 280 S/900-4

For mounting on existing pull-outs with a nominal depth of 450 mm and 500 mm.

- maximum frame height (dimension from the bottom of the drawer to the top edge of the frame) 175 mm
- minimum installation depth (internal dimension of the drawer) 400 mm
- waste volume 46 (2 x 16/ 2 x 7) litres
- total height 280 mm
- installation height without complete lid 270 mm
- complete lid can be mounted behind the upper front to save space
- bucket height 256 mm

8013397	without bio lid, anthracite, H 280 mm	€ 337.73
8013398	with bio lid, anthracite, H 280 mm	€ 349.65

Optional accessories

8013312	Bio-lid, anthracite, for 4/ 6/ 7/ 10/ 12.5 liters	€ 15.45
8011178	Bio-filter retrofitting set, black	€ 7.71
8013342	Closing-lid, anthracite, for 13/ 16/ 22/ 28 liters	€ 9.83
8013338	Closing-lid, anthracite, for 4/ 6/ 7/ 10/ 12.5 liters	€ 6.23



Cox Stand-UP® 350 S

The Cox-Stand-UP® waste system 350 is ideally suited for quick installation on existing pull-outs with a **nominal depth of 450 mm and 500 mm**. The total height of the system is 350 mm, whereby the **clear installation height is only 340 mm**. Depending on the installation situation, the fixed complete lid can also be mounted behind the upper front to save space. The maximum frame height (dimension from the pull-out shelf to the top edge of the frame) is 245 mm.

The Cox-Stand-UP® waste system is available in different heights, cabinet widths and bucket combinations.

Container fitting system/litres				
Cabinet Body	500	500	600	600
	16 10 10	16 22	22 10 10	22 22
Cabinet Body	800		900	
	22 16 10 10	22 22 10 10	22 22 22	

Waste collectors

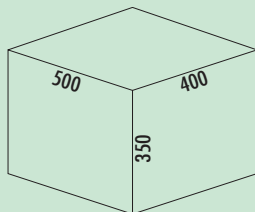

Cox Stand-UP® 350 S/500-2

For mounting on existing pull-outs with a nominal depth of 450 mm and 500 mm.

- maximum frame height (dimension from the bottom of the drawer to the top edge of the frame) 245 mm
- minimum installation depth (internal dimension of the drawer) 400 mm
- waste volume 38 (1 x 16/1 x 22) litres
- total height 350 mm
- installation height without complete lid 340 mm
- complete lid can be mounted behind the upper front to save space
- bucket height 326 mm

8013423 anthracite, H 350 mm € 213.89

Optional accessories

8013342 Closing-lid, anthracite, for 13/ 16/ 22/ 28 liters € 9.83

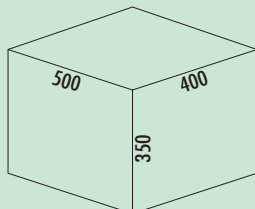

Cox Stand-UP® 350 S/500-3

For mounting on existing pull-outs with a nominal depth of 450 mm and 500 mm.

- maximum frame height (dimension from the bottom of the drawer to the top edge of the frame) 245 mm
- minimum installation depth (internal dimension of the drawer) 400 mm
- waste volume 36 (2 x 10/1 x 16) litres
- total height 350 mm
- installation height without complete lid 340 mm
- complete lid can be mounted behind the upper front to save space
- bucket height 326 mm

8013399 anthracite, H 350 mm € 222.41

Optional accessories

8013338 Closing-lid, anthracite, for 4/ 6/ 7/ 10/ 12.5 liters € 6.23

8013341 Closing-lid, anthracite, for 10/ 12/ 16/ 21 liters € 9.12

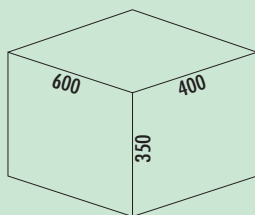

Cox Stand-UP[®] 350 S/600-2

For mounting on existing pull-outs with a nominal depth of 450 mm and 500 mm.

- maximum frame height (dimension from the bottom of the drawer to the top edge of the frame) 245 mm
- minimum installation depth (internal dimension of the drawer) 400 mm
- waste volume 44 (2 x 22) litres
- total height 350 mm
- installation height without complete lid 340 mm
- complete lid can be mounted behind the upper front to save space
- bucket height 326 mm

8013424 without bio lid, anthracite, H 350 mm € 218.60

Optional accessories

8013342 Closing-lid, anthracite, for 13/ 16/ 22/ 28 liters € 9.83

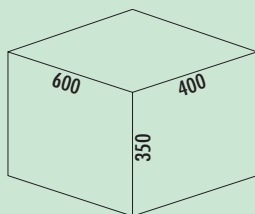

Cox Stand-UP[®] 350 S/600-3

For mounting on existing pull-outs with a nominal depth of 450 mm and 500 mm.

- maximum frame height (dimension from the bottom of the drawer to the top edge of the frame) 245 mm
- minimum installation depth (internal dimension of the drawer) 400 mm
- waste volume 42 (2 x 10/1 x 22) litres
- total height 350 mm
- installation height without complete lid 340 mm
- complete lid can be mounted behind the upper front to save space
- bucket height 326 mm

8013410 without bio lid, anthracite, H 350 mm € 229.86

8013411 with bio lid, anthracite, H 350 mm € 242.85

Optional accessories

8013312 Bio-lid, anthracite, for 4/ 6/ 7/ 10/ 12.5 liters € 15.45

8011178 Bio-filter retrofitting set, black € 7.71

8013338 Closing-lid, anthracite, for 4/ 6/ 7/ 10/ 12.5 liters € 6.23

8013342 Closing-lid, anthracite, for 13/ 16/ 22/ 28 liters € 9.83

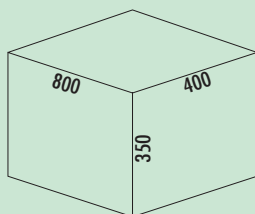

Cox Stand-UP[®] 350 S/800-4

For mounting on existing pull-outs with a nominal depth of 450 mm and 500 mm.

- maximum frame height (dimension from the bottom of the drawer to the top edge of the frame) 245 mm
- minimum installation depth (internal dimension of the drawer) 400 mm
- waste volume 58 (2 x 10/1 x 22/1 x 16) litres
- total height 350 mm
- installation height without complete lid 340 mm
- complete lid can be mounted behind the upper front to save space
- bucket height 326 mm

8013412 without bio lid, anthracite, H 350 mm € 328.42

8013413 with bio lid, anthracite, H 350 mm € 341.29

Optional accessories

8013312 Bio-lid, anthracite, for 4/ 6/ 7/ 10/ 12.5 liters € 15.45

8011178 Bio-filter retrofitting set, black € 7.71

8013338 Closing-lid, anthracite, for 4/ 6/ 7/ 10/ 12.5 liters € 6.23

8013342 Closing-lid, anthracite, for 13/ 16/ 22/ 28 liters € 9.83

8013341 Closing-lid, anthracite, for 10/ 12/ 16/ 21 liters € 9.12

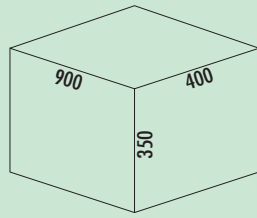

Cox Stand-UP® 350 S/900-3

- For mounting on existing pull-outs with a nominal depth of 450 mm and 500 mm.
- maximum frame height (dimension from the bottom of the drawer to the top edge of the frame) 245 mm
 - minimum installation depth (internal dimension of the drawer) 400 mm
 - waste volume 66 (3 x 22) litres
 - total height 350 mm
 - installation height without complete lid 340 mm
 - complete lid can be mounted behind the upper front to save space
 - bucket height 326 mm

8013414 without bio lid, anthracite, H 350 mm € 337.73

Optional accessories

8013342 Closing-lid, anthracite, for 13/ 16/ 22/ 28 liters € 9.83

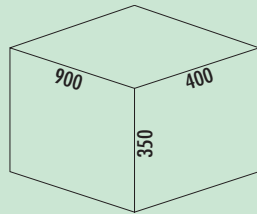

Cox Stand-UP® 350 S/900-4

- For mounting on existing pull-outs with a nominal depth of 450 mm and 500 mm.
- maximum frame height (dimension from the bottom of the drawer to the top edge of the frame) 245 mm
 - minimum installation depth (internal dimension of the drawer) 400 mm
 - waste volume 64 (2 x 22/2 x 10) litres
 - total height 350 mm
 - installation height without complete lid 340 mm
 - complete lid can be mounted behind the upper front to save space
 - bucket height 326 mm

8013415 without bio lid, anthracite, H 350 mm € 349.93

8013416 with bio lid, anthracite, H 350 mm € 362.64

Optional accessories

8013312 Bio-lid, anthracite, for 4/ 6/ 7/ 10/ 12.5 liters € 15.45

8011178 Bio-filter retrofitting set, black € 7.71

8013342 Closing-lid, anthracite, for 13/ 16/ 22/ 28 liters € 9.83

8013338 Closing-lid, anthracite, for 4/ 6/ 7/ 10/ 12.5 liters € 6.23

Waste collectors



Cox Stand-UP[®] 350 S

The Cox-Stand-UP[®] waste system 350 is ideally suited for quick installation on existing pull-outs with a **nominal depth of 450 mm and 500 mm**. The total height of the system is 350 mm, whereby the **clear installation height is only 340 mm**. Depending on the installation situation, the fixed complete lid can also be mounted behind the upper front to save space. The maximum frame height (dimension from the pull-out shelf to the top edge of the frame) is 245 mm.

The Cox-Stand-UP[®] waste system is available in different heights, cabinet widths and bucket combinations.

Container fitting system/litres				
Cabinet Body	500K		600K	
	12	7,5	15,5	7,5
		7,5		7,5

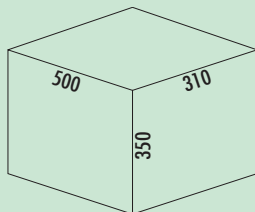

Cox Stand-UP[®] 350 K/500-3

For mounting on existing pull-outs with a shortened nominal depth of 400 mm.

- maximum frame height (dimension from the bottom of the drawer to the top edge of the frame) 245 mm
- minimum installation depth (internal dimension of the drawer) 310 mm
- waste volume 27 (2 X 7,5/ 1 x 12) litres
- total height 350 mm
- installation height without complete lid 340 mm
- installation depth of the complete lid 400mm
- complete lid can be mounted behind the upper front to save space
- bucket height 326 mm

8013404 anthracite, H 350 mm € 234.52

Optional accessories

8013497 Bio lid, anthracite, for 7.5 liters € 17.12

8013339 Closing-lid, anthracite, for 7.5/ 9/ 12 liters € 9.12

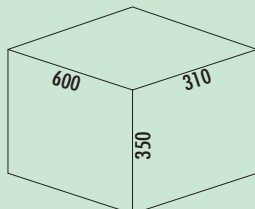

Cox Stand-UP[®] 350 K/600-3

For mounting on existing pull-outs with a shortened nominal depth of 400 mm. The 600 mm-wide Cox[®]-Stand-UP[®] waste system is supplied with a matching fixed complete lid for the cabinet. This creates additional practical storage space alongside the waste system in the pull-out.

- maximum frame height (dimension from the bottom of the drawer to the top edge of the frame) 245 mm
- minimum installation depth (internal dimension of the drawer) 310 mm
- waste volume 30.5 (2 x 7,5/1 x 15.5) litres
- total height 350 mm
- installation height without complete lid 340 mm
- installation depth of the complete lid 400 mm
- complete lid can be mounted behind the upper front to save space
- bucket height 326 mm

8013420 anthracite, H 350 mm € 273.68

Optional accessories

8013497 Bio lid, anthracite, for 7.5 liters € 17.12

8013344 Bio lid, anthracite, for 10/ 12/ 15.5 liters € 17.56

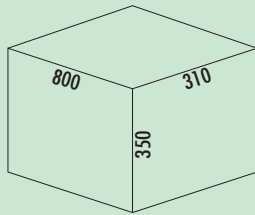

Cox Stand-UP® 350 K/800-3

For mounting on existing pull-outs with a shortened nominal depth of 400 mm. The 800 mm-wide Cox®-Stand-UP® waste system is supplied with a matching fixed complete lid for the cabinet. This creates additional practical storage space alongside the waste system in the pull-out.

- maximum frame height (dimension from the bottom of the drawer to the top edge of the frame) 245 mm
- minimum installation depth (internal dimension of the drawer) 310 mm
- waste volume 30.5 (2 x 7.5/1 x 15.5) litres
- total height 350 mm
- installation height without complete lid 340 mm
- installation depth of the complete lid 400 mm
- **width of the complete lid 800 mm**
- complete lid can be mounted behind the upper front to save space
- bucket height 326 mm

8013421 anthracite, H 350 mm € 277.00

Optional accessories

8013497 Bio lid, anthracite, for 7.5 liters € 17.12

8013344 Bio lid, anthracite, for 10/ 12/ 15.5 liters € 17.56

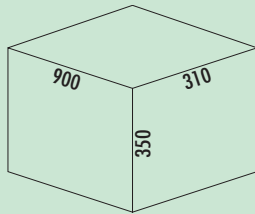

Cox Stand-UP® 350 K/900-3

For mounting on existing pull-outs with a shortened nominal depth of 400 mm. The 900 mm-wide Cox®-Stand-UP® waste system is supplied with a matching fixed complete lid for the cabinet. This creates additional practical storage space alongside the waste system in the pull-out.

- maximum frame height (dimension from the bottom of the drawer to the top edge of the frame) 245 mm
- minimum installation depth (internal dimension of the drawer) 310 mm
- waste volume 30.5 (2 x 7.5/1 x 15.5) litres
- total height 350 mm
- installation height without complete lid 340 mm
- installation depth of the complete lid 400 mm
- **width of the complete lid 900 mm**
- complete lid can be mounted behind the upper front to save space
- bucket height 326 mm

8013422 anthracite, H 350 mm € 283.21

Optional accessories

8013497 Bio lid, anthracite, for 7.5 liters € 17.12

8013344 Bio lid, anthracite, for 10/ 12/ 15.5 liters € 17.56

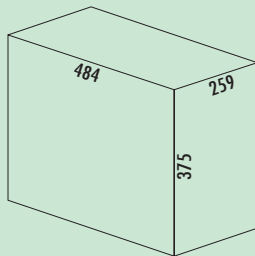

Tandem 2

- waste capacity 30 (2 x 15) liters
- technology: for existing pull-outs
- fitting: on tray pull-out or in a drawer

8011053 graphite grey € 144.46

SELECTAkit®

Pull-out technology for existing pull-outs

Pullboy Vario



Convincing benefits at a glance

Variable solution with anti-slip mats for all common pull-out models.

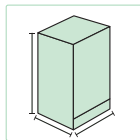

suitable for cabinets
from 30 to 120 cm



single lid



The system can be
adapted to different
widths by cutting an
anti-slip mat to size.

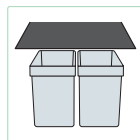

fixed complete lid
possible up to 60 cm
wide

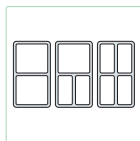

2-4 fold separation

Divisions

Pullboy Vario
installation depth 500 mm

320 S/400-2
335 S/300-2



320 S/450-2



320 S/500-3



300 S/800-4
320 S/600-4



Pullboy Vario

The Pullboy Vario waste system for existing pull-outs requires installation heights of between 300 and 335 millimetres. Space-saving container combinations and the practical complete lid provide optimal storage organisation. Up to four waste containers can be securely positioned on the anti-slip mat. Pullboy Vario is designed for various cabinet widths and is quick to assemble.

Container fitting system/litres				
Cabinet body	300	400	450	500
Cabinet body	600		800/900/100/120	

Abfallsammler

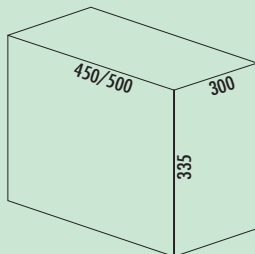

Pullboy Vario 335 S/300-2

With non-slip inlay mat and complete lid.
 Can be cut to fit all standard drawers.
 Cutting dimensions of the mat:
 max. 220 x 556 mm (W x D)
 min. 205 x 400 mm (W x D)
 – waste capacity 25 (1 x 17/1 x 8) liters
 – **the ideal space saver with an installation height of only 335 mm**

8011623 aluminium grey € 118.56

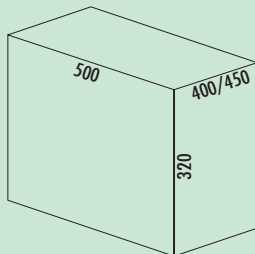

Pullboy Vario 320 S/400-2

With non-slip inlay mat and complete lid.
 Can be cut to fit all standard drawers.
 Cutting dimensions of the mat:
 max. 368 x 565 mm (W x D)
 min. 230 x 456 (W x D)
 – waste capacity 25 (1 x 17/1 x 8) liters
 – **the ideal space saver with an installation height of only 320 mm**

8011605 aluminium grey € 100.65

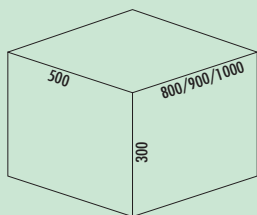

Pullboy Vario 300 S/800-4

With non-slip inlay mat and single lid.
 Can be cut to fit all standard drawers.
 Cutting dimensions of the mat:
 max. 1125 x 565 mm (W x T)
 min. 468 x 456 mm (W x T)
 – waste capacity 50 (2 x 8/2 x 17) liters
 – **the ideal space saver with an installation height of only 300 mm**

8011640 aluminium grey

€ 111.73

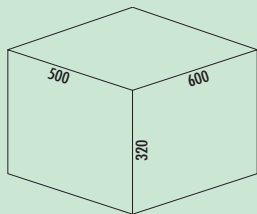

Pullboy Vario 320 S/600-4

With non-slip inlay mat and complete lid.
 Can be cut to fit all standard drawers.
 Cutting dimensions of the mat in mm:
 max. 565 x 565 (W x D)
 min. 468 x 456 (W x D)
 – waste capacity 50 (2 x 8/2 x 17) liters
 – **the ideal space saver with an installation height of only 320 mm**

8012006 aluminium grey

€ 175.71

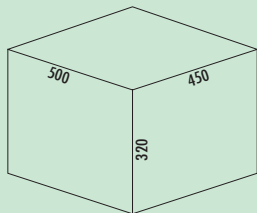

Pullboy Vario 320 S/450-2

With non-slip inlay mat and complete lid.
 Can be cut to fit all standard drawers.
 Cutting dimensions of the mat:
 max. 462 x 565 mm (W x T)
 min. 311 x 456 (W x T)
 – waste capacity 34 (2 x 17) liters
 – **the ideal space saver with an installation height of only 320 mm**

8012007 aluminium grey

€ 133.06

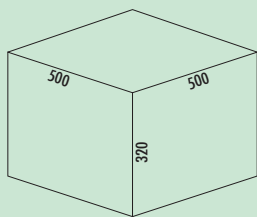

Pullboy Vario 320 S/500-3

- With non-slip inlay mat and complete lid.
- Can be cut to fit all standard drawers.
- Cutting dimensions of the mat:
 - max. 462 x 565 mm (W x D)
 - min. 311 x 456 mm (W x D)
- waste capacity 33 (2 x 8/1 x 17) liters
- **the ideal space saver with an installation height of only 320 mm**



8012010 aluminium grey

€ 140.48

Waste
collectors

SELECTAkit®

Pull-out technology for existing pull-outs



Pullboy Versa®

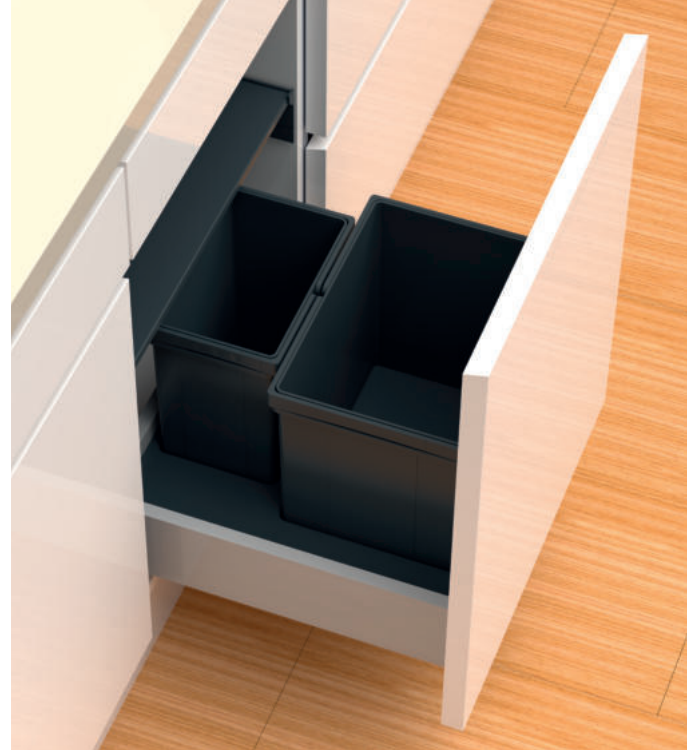

Convincing benefits at a glance

System for existing pull-outs with a tray for secure positioning. Ideal for a multi-part front design.

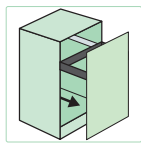

mounting on existing pull-outs for cabinet widths of 500–600 mm



with single lids

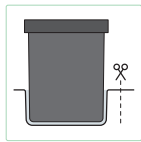

with a tray that can be cut to size for secure positioning

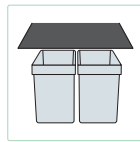

optional complete lid can be mounted behind the front in the cabinet body to save space

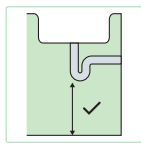

the height of the entire system is only 265 mm



ideally suited for multi-part front design, can be cut to all pull-outs with a nominal depth of 400 and 500 mm

Divisions

Pullboy Versa® 265 K
installation depth 400 mm



265 K/500-2



265 K/500-3

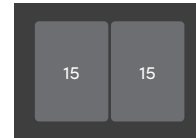

265 K/600-2

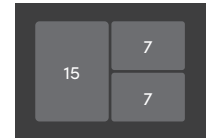

265 K/600-3



265 K/600-4

Pullboy Versa® 265 S
installation depth 500 mm

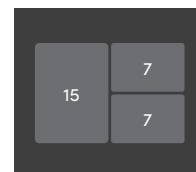

265 S/500-3

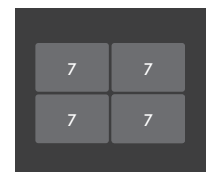

265 S/500-4

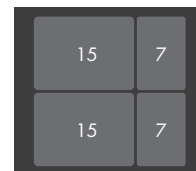

265 S/600-4z



Pullboy Versa[®] 265 K

The Pullboy Versa waste system is ideally suited for a front design consisting of several parts and can be cut to size for all pull-outs with a nominal depth of 400 mm.

- with individual lids and the optional fixed complete lid
- with insert tray for secure positioning
- for mounting on existing pull-outs
- the height of the entire system is only 265 mm
- the complete lid can be mounted behind the top front to save space

Container fitting systems/litres						
Cabinet body	500	500	600	600	600	800/900/1000
	7 15	7 7 7	15 15	15 7 7	7 7 7 7	15 15 7 7

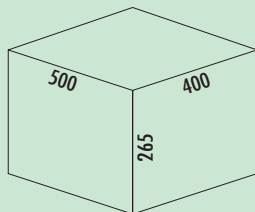

Pullboy Versa[®] 265 K/500-2

For mounting on existing pull-outs with a nominal depth of 400 mm.

- minimum installation depth (internal drawer dimensions) 400 mm
- waste volume 22 (1 x 7/1 x 15) litres
- incl. single lid
- total height 265 mm
- optional complete lid can be fitted behind the top front to save space
- base tray 462 x 400 mm (W x D), can be cut to size



8011711 anthracite, H 265 mm € 81.03

Optional accessories

8011718 Pullboy[®] complete lid 1, anthracite, W 500 mm € 57.14

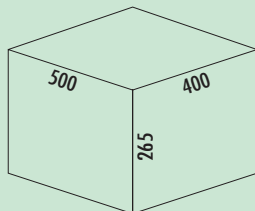

Pullboy Versa[®] 265 K/500-3

For mounting on existing pull-outs with a nominal depth of 400 mm.

- minimum installation depth (internal drawer dimensions) 400 mm
- waste volume 21 (3 x 7) litres
- incl. single lid
- total height 265 mm
- optional complete lid can be fitted behind the top front to save space
- base tray 462 x 400 mm (W x D), can be cut to size



8011710 anthracite, H 265 mm € 90.42

Optional accessories

8011718 Pullboy[®] complete lid 1, anthracite, W 500 mm € 57.14

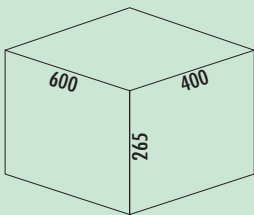

Pullboy Versa® 265 K/600-2

- For mounting on existing pull-outs with a nominal depth of 400 mm.
- minimum installation depth (internal drawer dimensions) 400 mm
 - waste volume 30 (2 x 15) litres
 - incl. single lid
 - total height 265 mm
 - optional complete lid can be fitted behind the top front to save space
 - base tray 562 x 400 mm (W x D), can be cut to size

8011715 anthracite, H 265 mm € 85.29

Optional accessories

8011719 Pullboy® complete lid 1, anthracite, W 600 mm € 60.55

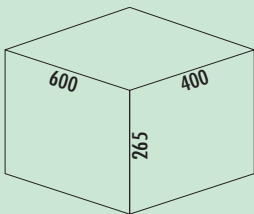

Pullboy Versa® 265 K/600-3

- For mounting on existing pull-outs with a nominal depth of 400 mm.
- minimum installation depth (internal drawer dimensions) 400 mm
 - waste volume 29 (2 x 7/1 x 15) litres
 - incl. single lid
 - total height 265 mm
 - optional complete lid can be fitted behind the top front to save space
 - base tray 562 x 400 mm (W x D), can be cut to size

8011716 anthracite, H 265 mm € 95.53

Optional accessories

8011719 Pullboy® complete lid 1, anthracite, W 600 mm € 60.55

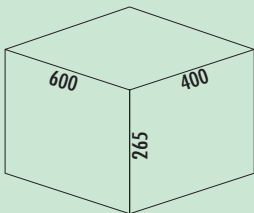

Pullboy Versa® 265 K/600-4

- For mounting on existing pull-outs with a nominal depth of 400 mm.
- minimum installation depth (internal dimension of the drawer) 400 mm
 - waste volume 28 (4 x 7) litres
 - incl. individual lid
 - total height 265 mm
 - optional complete lid can be mounted behind the upper front to save space
 - base tray 562 x 400 mm (W x D), can be cut to size

8011714 anthracite, H 265 mm € 104.91

Optional accessories

8011719 Pullboy® complete lid 1, anthracite, W 600 mm € 60.55

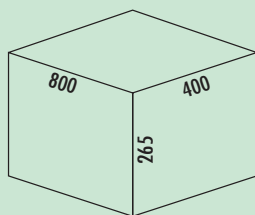
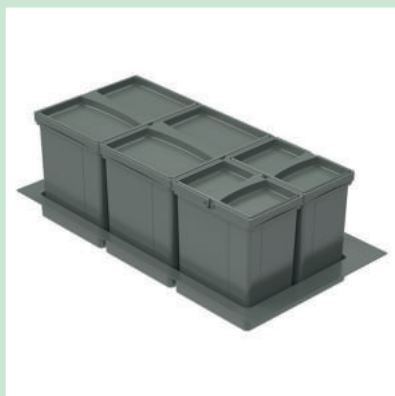

Pullboy Versa® 265 K/800-4

For mounting on existing pull-outs with a nominal depth of 400 mm.

- minimum installation depth (internal dimension of the drawer) 400 mm
- waste volume 44 (2 x 15/2 x 7) litres
- incl. individual lid
- total height 265 mm
- optional complete lid can be mounted behind the upper front to save space
- base tray 762 x 400 mm (W x D), can be cut to size

8012710 anthracite, H 265 mm € 152.68

Optional accessories

8012716 Pullboy® complete lid 2, anthracite, W 800 mm € 71.13

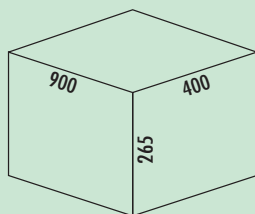
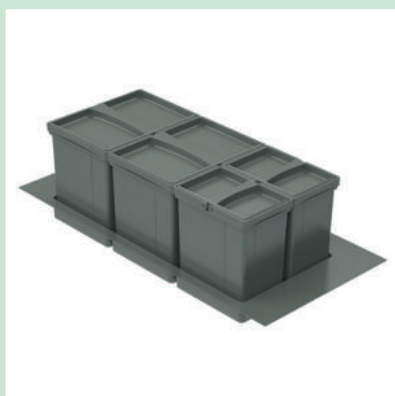

Pullboy Versa® 265 K/900-4

For mounting on existing pull-outs with a nominal depth of 400 mm.

- minimum installation depth (internal dimension of the drawer) 400 mm
- waste volume 44 (2 x 15/2 x 7) litres
- incl. individual lid
- total height 265 mm
- optional complete lid can be mounted behind the upper front to save space
- base tray 862 x 400 mm (W x D), can be cut to size

8012712 anthracite, H 265 mm € 152.68

Optional accessories

8012717 Pullboy® complete lid 2, anthracite, W 900 mm € 72.93

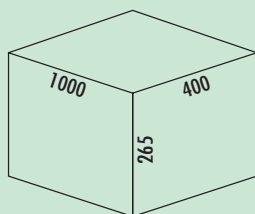
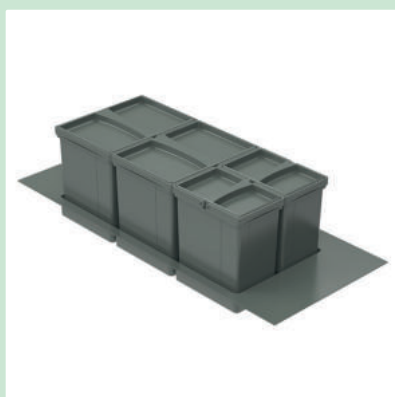

Pullboy Versa® 265 K/1000-4

For mounting on existing pull-outs with a nominal depth of 400 mm.

- minimum installation depth (internal dimension of the drawer) 400 mm
- waste volume 44 (2 x 15/2 x 7) litres
- incl. individual lid
- total height 265 mm
- optional complete lid can be mounted behind the upper front to save space
- base tray 962 x 400 mm (W x D), can be cut to size

8012714 anthracite, H 265 mm € 152.68

Optional accessories

8012718 Pullboy® complete lid 2, anthracite, W 1000 mm € 74.98

Waste collectors



Pullboy Versa® 265 S

The Pullboy Versa waste system is ideally suited for a front design consisting of several parts and can be cut to size for all pull-outs with a nominal depth of 500 mm.

- with individual lids and the optional fixed complete lid
- with insert tray for secure positioning
- for mounting on existing pull-outs
- the height of the entire system is only 265 mm
- the complete lid can be mounted behind the top front to save space

Container fitting systems/litres																						
Cabinet body	500	500	600	800/900/1000																		
	<table border="1"> <tr><td>15</td><td>7</td></tr> <tr><td></td><td>7</td></tr> </table>	15	7		7	<table border="1"> <tr><td>7</td><td>7</td></tr> <tr><td>7</td><td>7</td></tr> </table>	7	7	7	7	<table border="1"> <tr><td>15</td><td>7</td></tr> <tr><td>15</td><td>7</td></tr> </table>	15	7	15	7	<table border="1"> <tr><td>15</td><td>15</td><td>7</td></tr> <tr><td></td><td></td><td>7</td></tr> </table>	15	15	7			7
15	7																					
	7																					
7	7																					
7	7																					
15	7																					
15	7																					
15	15	7																				
		7																				

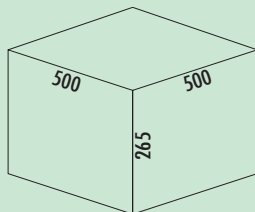

Pullboy Versa® 265 S/500-3

For mounting on existing pull-outs with a nominal depth of 500 mm.

- minimum installation depth (internal drawer dimensions) 500 mm
- waste volume 29 (2 x 7/ 1 x 15) litres
- incl. single lid
- total height 265 mm
- optional complete lid can be fitted behind the top front to save space
- base tray 462 x 500 mm (W x D), can be cut to size

8011713 anthracite, H 265 mm € 95.53

Optional accessories

8011718 Pullboy® complete lid 1, anthracite, W 500 mm € 57.14

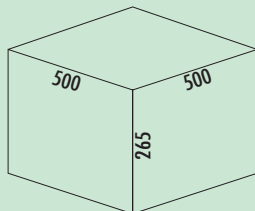

Pullboy Versa® 265 S/500-4

For mounting on existing pull-outs with a nominal depth of 500 mm.

- minimum installation depth (internal drawer dimensions) 500 mm
- waste volume 25 (4 x 7) litres
- incl. single lid
- total height 265 mm
- optional complete lid can be fitted behind the top front to save space
- base tray 462 x 500 mm (W x D), can be cut to size

8011712 anthracite, H 265 mm € 104.91

Optional accessories

8011718 Pullboy® complete lid 1, anthracite, W 500 mm € 57.14

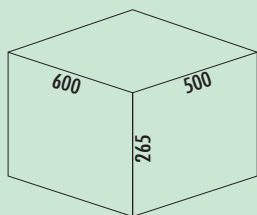

Pullboy Versa® 265 S/600-4

- For mounting on existing pull-outs with a nominal depth of 500 mm.
- minimum installation depth (internal drawer dimensions) 500 mm
- waste volume 44 (2 x 7/ 2 x 15) litres
- incl. single lid
- total height 265 mm
- optional complete lid can be fitted behind the top front to save space
- base tray 562 x 500 mm (W x D), can be cut to size

8011717 anthracite, H 265 mm € 121.12

Optional accessories

8011719 Pullboy® complete lid 1, anthracite, W 600 mm € 60.55

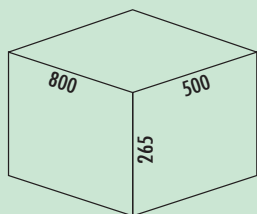
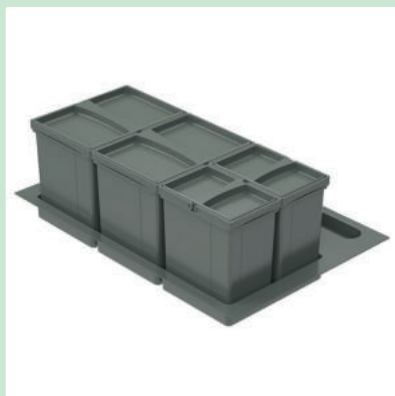

Pullboy Versa® 265 S/800-4

- For mounting on existing pull-outs with a nominal depth of 500 mm.
- minimum installation depth (internal drawer dimensions) 500 mm
- waste volume 44 (2 x 7/ 2 x 15) litres
- incl. single lid
- total height 265 mm
- optional complete lid can be fitted behind the top front to save space
- base tray 762 x 500 mm (W x D), can be cut to size

8012711 anthracite, H 265 mm € 152.68

Optional accessories

8012716 Pullboy® complete lid 2, anthracite, W 800 mm € 71.13

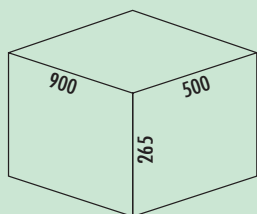
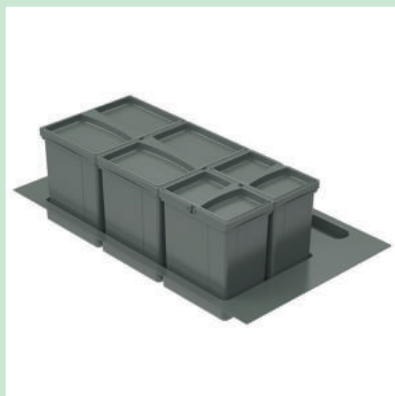

Pullboy Versa® 265 S/900-4

- For mounting on existing pull-outs with a nominal depth of 500 mm.
- minimum installation depth (internal drawer dimensions) 500 mm
- waste volume 44 (2 x 7/ 2 x 15) litres
- incl. single lid
- total height 265 mm
- optional complete lid can be fitted behind the top front to save space
- base tray 862 x 500 mm (W x D), can be cut to size

8012713 anthracite, H 265 mm € 152.68

Optional accessories

8012717 Pullboy® complete lid 2, anthracite, W 900 mm € 72.93

Waste collectors

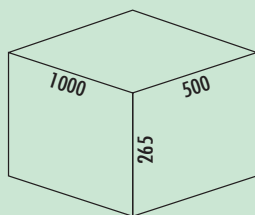
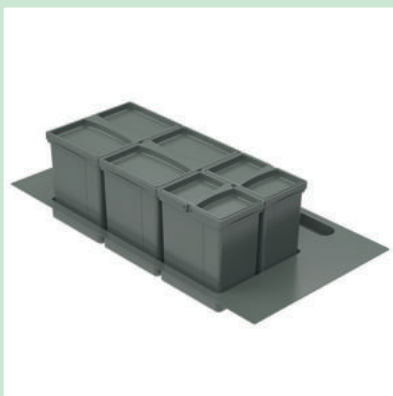

Pullboy Versa® 265 S/1000-4

- For mounting on existing pull-outs with a nominal depth of 500 mm.
- minimum installation depth (internal drawer dimensions) 500 mm
 - waste volume 44 (2 x 7/ 2 x 15) litres
 - incl. single lid
 - total height 265 mm
 - optional complete lid can be fitted behind the top front to save space
 - base tray 962 x 500 mm (W x D), can be cut to size

8012715 anthracite, H 265 mm € 152.68

Optional accessories

8012718 Pullboy® complete lid 2, anthracite, W 1000 mm € 74.98

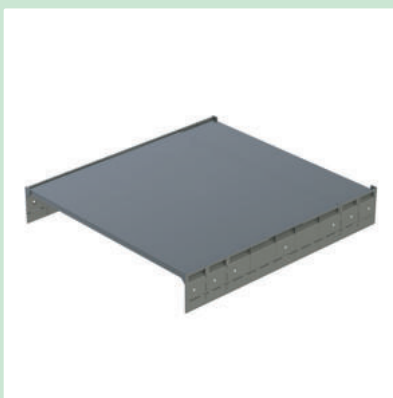

Pullboy® complete lid 1

- Powder-coated metal cover for installation depth 400 and 500 mm for optional mounting.
- height 20 mm
 - cover can be shortened from 500 to 400 mm by removing the rear element and fitted behind the top front to save space
 - side mounting rails can be shortened from 500 to 400 mm using predetermined breaking points

8011718 anthracite, W 500 mm € 57.14

8011719 anthracite, W 600 mm € 60.55



Pullboy® complete lid 2

- Powder-coated metal lid for installation depth 400 mm, for optional mounting.
- height 20 mm
 - lid can be mounted behind the upper front to save space
 - side mounting rail with a length of 400 mm

8012716 anthracite, W 800 mm € 71.13

8012717 anthracite, W 900 mm € 72.93

8012718 anthracite, W 1000 mm € 74.98



Cox® Giallo

Cox® Giallo lets the bin bag disappear elegantly and invisibly behind the front. An integrated clamping bracket fixes the bin bag. The collecting tray below the bin bag ensures that, if the worst comes to the worst, no liquids get into the furniture body. The integrated metal lid minimises odours.

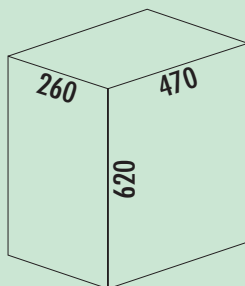

Cox® Giallo

Pullout box frame for the bin bag, for mounting on existing pull-outs.

- for all common pullouts
- waste volume approx. 43 liters
- total height **620 mm**
- metal lid (side wall mounting)
- mounting: pull-out base and front panel
- with removable collecting tray and foldable holding clamp
- **The clear internal width of the pullout must not be less than 180 mm.**



8012378 silver

€ 300.26



X-LINE

The X-LINE series for existing drawer pull-outs combines practical advantages with space-saving design. The waste separation systems can be quickly installed and are also easy to remove. This makes cleaning as simple as possible.

With the adjustable ratchet included, the waste system can be used in all drawers with a depth of 400–500 mm. This ensures that the storage space is optimally utilised, and the system adapts seamlessly to the different widths, heights and depths of the kitchen installations.

The X-LINE dividing strip is the elegant solution for dividing an X-LINE 35 l waste container for two 17 l waste bags.

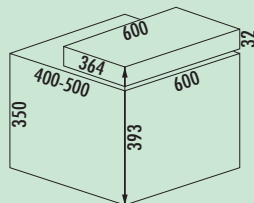
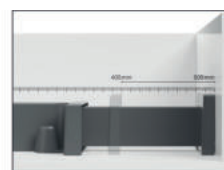
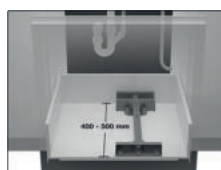

X-LINE 600/M7 with Basic drawer

For mounting on existing pull-outs. Drawer with part pull-out on plastic runners.

- variable installation depth 366–494 mm
- installation height 367 mm
- waste volume 50 (1 x 35/1 x 15) liters



8011295 anthracite € 275.24

Optional accessories

8011084 X-LINE Dividing strip, anthracite € 39.50

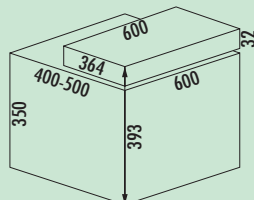

X-LINE 600/M5 with Basic drawer

For mounting on existing pull-outs. Drawer with part pull-out on plastic runners.

- variable installation depth 366–494 mm
- installation height 367 mm
- waste volume 48 (1 x 35/1 x 8/1 x 5) liters + two additional containers (1 x 1/1 x 0.5 l)



8011292 anthracite € 337.05

Optional accessories

8011084 X-LINE Dividing strip, anthracite € 39.50

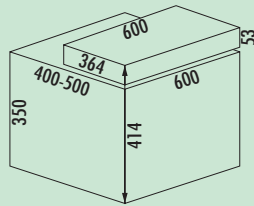

X-LINE 600/M7 with Premium drawer

For mounting on existing pull-outs. Drawer with full pull-out on ball bearing runners, rotating back panel and two additional bowls (0.9/1.3 l).

- variable installation depth 366–494 mm
- installation height 367 mm
- waste volume 50 (1 x 35/1 x 15) liters

8011296	anthracite	€ 339.66
---------	------------	----------

Optional accessories

8011084	X-LINE Dividing strip, anthracite	€ 39.50
---------	-----------------------------------	---------

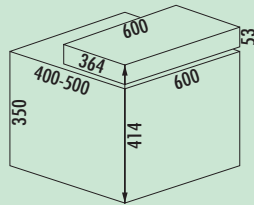

X-LINE 600/M5 with Premium drawer

For mounting on existing pull-outs. Drawer with full pull-out on ball bearing runners, rotating back panel and two additional bowls (1.3/1.3 l).

- variable installation depth 366–494 mm
- installation height 367 mm
- waste volume 48 (1 x 35/1 x 8/1 x 5) liters + two additional containers (1 x 1/1 x 0.5 l)

8011294	anthracite	€ 406.03
---------	------------	----------

SELECTAkit[®] Pull-out technology for existing pull-outs

Order no.

Description

per piece excl. VAT

Waste
collectors

SELECTakit®

Pull-out technology for rotating doors

The perfect supplement for functionality and ergonomics



Waste collectors

Clap	Page 210–212
Traditionline Double-Boy® 410 X	Page 213
Traditionline Double-Boy® 410 ECO	Page 213
Traditionline Double-Boy® 410 S	Page 213
Traditionline Trio-Boy® 410 S	Page 214
Traditionline Single-Boy® 485 K	Page 214
Traditionline Single-Boy® 585 K	Page 214
Traditionline Single-Boy® 545 S	Page 215
Traditionline Double-Master® 410 S	Page 215
Traditionline Trio-Master® 410 S	Page 215
Traditionline Double-Master® 345 S	Page 216
Traditionline Double-Master® 485 S	Page 216
Traditionline Trio-Master® 345 S	Page 216
Traditionline Double-Shorty® 345 K	Page 217
Traditionline Trio-Shorty® 345 K	Page 217
Traditionline Double-Shorty® 345 K	Page 218
Profiline Double-Boy® 345 S	Page 218
Profiline Double-Boy® 410 S	Page 218
Profiline Trio-Boy® 345 S	Page 219
Profiline Trio-Boy® 410 S	Page 219
Profiline Double-Master® 345 S	Page 219
Profiline Double-Master® 410 S	Page 220
Profiline Trio-Master® 345 S	Page 220
Profiline Trio-Master® 410 S	Page 220
Solo	Page 221
Tandem 8	Page 221
Cleaning agent pullout Carry	Page 222
Tandem 7 K	Page 222
Tandem S	Page 223–224
Tandem 4/5	Page 224
Easy Cargo 1	Page 225
Traditionline Double-Master® Corner	Page 226
Rondo® plus	Page 227–228
Rondo® plus deflector for hoses with shower head	Page 228
Rollwagen DS	Page 230
Profiline Double-Master® DS 360 S	Page 230
Traditionline Trio-Master® DS 360 S	Page 231

Suitable for the following front layouts:



Full front

Front panel with one division

Please check the heights of the product groups.



Clap

The successful combination of convenience properties in smooth-running design with the optional versatility of waste separation down to fractions makes Clap an all-rounder in its class. Ultimately, its attractiveness is not only defined by its economic construction and design. Corresponding to the Naber product concept "the next generation", all materials employed are fully recyclable.

- fitted with telescopic full pull-out with ball bearings
- sturdy plastic containers for individual separation of recyclable materials
- covering of the body structure may be used for storage of dishwashing paraphernalia
- easy installation due to simple mounting on the cabinet floor

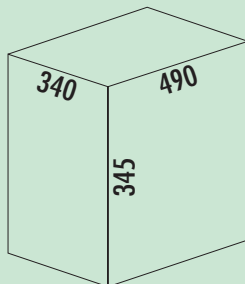

Clap 345 S/450-3

- waste capacity 30 (2 x 7.5/1 x 15) liters
- technology: full pull-out
- fitting: cabinet bottom
- **the ideal space saver with an installation height of only 345 mm**

8011453 anthracite

€ 131.39

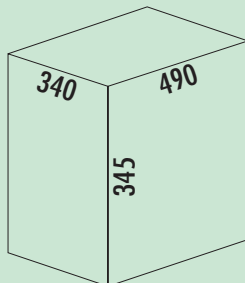

Clap 345 S/450-2

- waste capacity 30 (2 x 15) liters
- technology: full pull-out
- fitting: cabinet bottom
- **the ideal space saver with an installation height of only 345 mm**

8011452 anthracite

€ 110.68

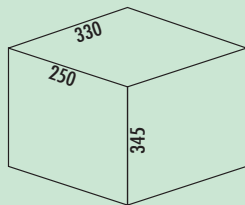

Clap 345 K/300-1

- waste capacity 15 liters
- technology: full pull-out
- fitting: cabinet bottom
- **the ideal space saver with an installation height of only 345 mm**

8011450 anthracite

€ 91.98

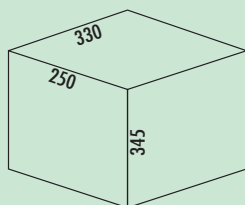

Clap 345 K/300-2

- waste capacity 15 (2 x 7.5) liters
- technology: full pull-out
- fitting: cabinet bottom
- **the ideal space saver with an installation height of only 345 mm**

8011451 anthracite

€ 106.99



Clap 3

Space-saving built-in waste collection system with full pull-out technology for rotating doors.

– installation height 345 mm and installation depth 330 mm

Ideally suited for installation with sub-frame appliances, water connections and siphon in the floor cabinet.

- despite its shortness 30 l filling volume
- minimum cabinet width 500 mm
- simple floor mounting

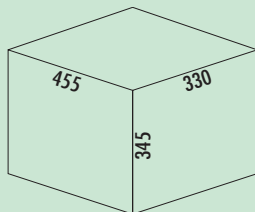

Clap 345 K/500-2

- waste capacity 30 (2 x 15) liters
- technology: full pull-out
- fitting: cabinet bottom
- the ideal space saver with an installation height of only 345 mm
- only 330 mm installation depth



8011454 anthracite

€ 120.06

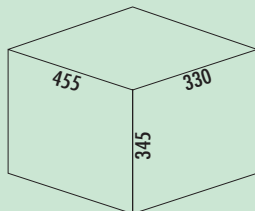

Clap 345 K/500-3

- waste capacity 30 (2 x 7.5/1 x 15) liters
- technology: full pull-out
- fitting: cabinet bottom
- the ideal space saver with an installation height of only 345 mm
- only 330 mm installation depth



8011455 anthracite

€ 128.58

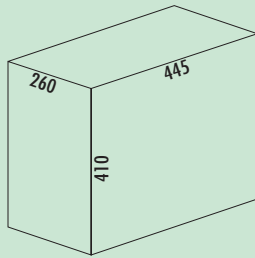

Traditionline Double-Boy® 410 X/300-2

- waste capacity 30 (2 x 15) liters
- technology: full pull-out
- fitting: cabinet bottom

8011916	anthracite	€ 116.00
8011912	aluminium grey	€ 116.00

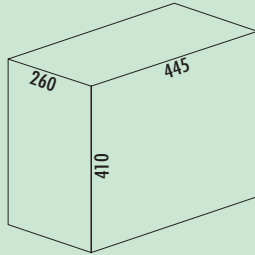

Traditionline Double-Boy® 410 ECO/300-2

- waste capacity 30 (2 x 15) litres
- technology: full pull-out
- fitting: cabinet bottom

8011918	black	€ 100.47
---------	-------	----------

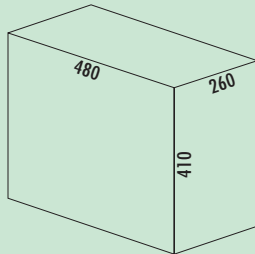

Traditionline Double-Boy® 410 S/300-2

- waste capacity 30 (1 x 20/1 x 10) liters
- technology: full pull-out
- fitting: cabinet bottom

8011112	aluminium grey	€ 158.59
---------	----------------	----------

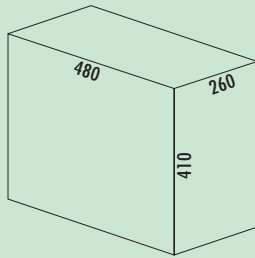

Traditionline Trio-Boy® 410 S/300-3

- waste capacity 30 (3 x 10) liters
- technology: full pull-out
- fitting: cabinet bottom

8011027 aluminium grey

€ 150.09

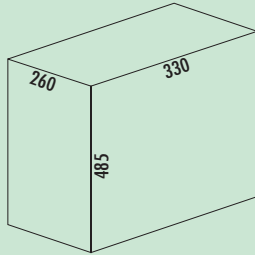

Traditionline Single-Boy® 485 K/300-1

- waste capacity 26 liters
- technology: full pull-out
- frame/guide silver
- complete lid aluminium grey
- fitting: cabinet bottom

8011010 aluminium grey

€ 168.87

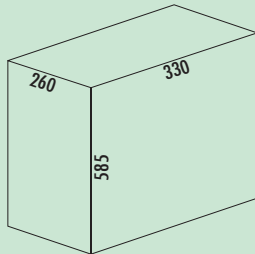

Traditionline Single-Boy® 585 K/300-1

- waste capacity 32 liters
- technology: full pull-out
- frame/guide silver
- complete lid aluminium grey
- fitting: cabinet bottom

8011014 aluminium grey

€ 175.44

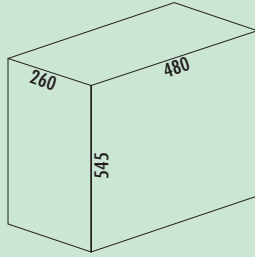

Traditionline Single-Boy® 545 S/300-1

- waste capacity 42 liters
- technology: full pull-out
- frame/guide silver
- complete lid aluminium grey
- fitting: cabinet bottom

8011917 aluminium grey

€ 185.09

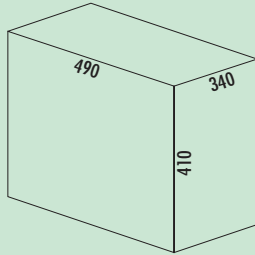

Traditionline Double-Master® 410 S/400-2

- waste capacity 40 (2 x 20) liters
- technology: full pull-out
- fitting: cabinet bottom

8011115 aluminium grey

€ 182.99

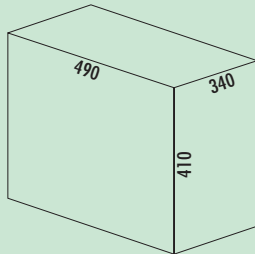

Traditionline Trio-Master® 410 S/400-3

- waste capacity 40 (2 x 10/1 x 20) liters
- technology: full pull-out
- fitting: cabinet bottom

8011113 aluminium grey

€ 186.68

Optional accessories

8011195 Closing-lid, aluminium grey, for 7, 8, 10 liters

€ 11.41

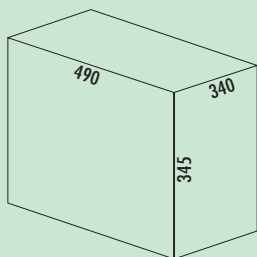

Traditionline Double-Master® 345 S/400-2

- waste capacity 32 (2 x 16) liters
- technology: full pull-out
- fitting: cabinet bottom
- **the ideal space saver with an installation height of only 345 mm**

801111 aluminium grey

€ 144.46

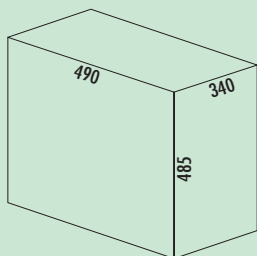

Traditionline Double-Master® 485 S/400-2

- waste capacity 52 (2 x 26) liters
- technology: full pull-out
- frame/guide aluminium grey
- complete lid aluminium grey
- fitting: cabinet bottom

801122 aluminium grey

€ 221.44

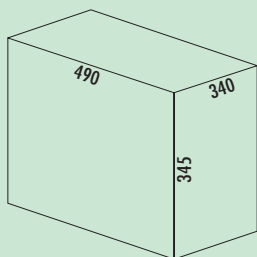

Traditionline Trio-Master® 345 S/400-3

- waste capacity 32 (2 x 8/1 x 16) liters
- technology: full pull-out
- fitting: cabinet bottom
- **the ideal space saver with an installation height of only 345 mm**

801116 aluminium grey

€ 158.59

Optional accessories

801195 Closing-lid, aluminium grey, for 7, 8, 10 liters

€ 11.41



Traditionline Double-Shorty®

- Built-in waste collector with full pull-out technology for rotating doors.
- installation height only 345 mm and installation depth only 325 mm! Therefore creates space for siphon, water connections and sub-frame equipment
- despite the shortness – 30 l capacity
- minimum cabinet width 500 mm
- quick and easy floor installation

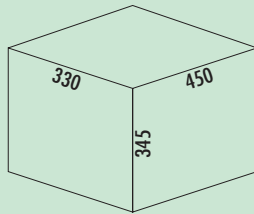

Traditionline Double-Shorty® 345 K/500-2

- waste capacity 30 (2 x 15) liters
- technology: full pull-out
- fitting: cabinet bottom
- with an installation height of only 345 mm and an installation depth of only 330 mm the ideal space saver



8011058 aluminium grey

€ 126.65

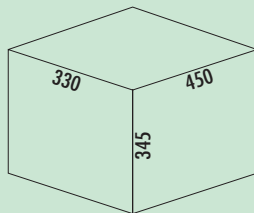

Traditionline Trio-Shorty® 345 K/500-3

- waste capacity 30 (2 x 7.5/1 x 15) liters
- technology: full pull-out
- fitting: cabinet bottom
- with an installation height of only 345 mm and an installation depth of only 330 mm the ideal space saver



8011188 aluminium grey

€ 142.62

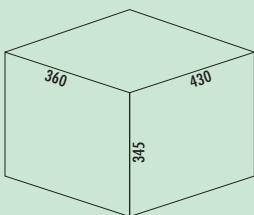

Traditionline Double-Shorty® 345 K/500-2 with carrier

- waste capacity 30 (2 x 15) liters
- technology: full pull-out
- fitting: cabinet bottom
- **complete with cam for rotating doors**
- **a door opening angle of 110° is required**
- **with an installation height of only 345 mm and an installation depth of only 360 mm the ideal space saver**

8011208 anthracite € 218.63

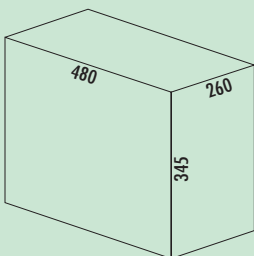

Profiline Double-Boy® 345 S/300-2

- waste capacity 24 (1 x 16/1 x 8) liters
- technology: full pull-out
- frame/guide silver
- complete lid anthracite
- fitting: cabinet bottom
- **the ideal space saver with an installation height of only 345 mm**

8012075 with bio lid, anthracite € 178.25

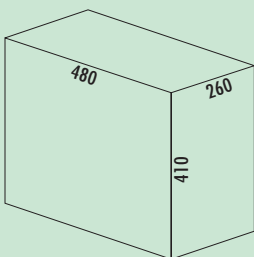

Profiline Double-Boy® 410 S/300-2

- waste capacity 30 (1 x 20/1 x 10) liters
- technology: full pull-out
- frame/guide silver
- complete lid anthracite
- fitting: cabinet bottom
- **the ideal space saver with an installation height of only 410 mm**

8012074 with bio lid, anthracite € 183.88

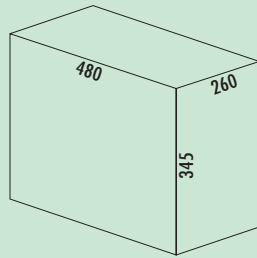

Profiline Trio-Boy® 345 S/300-3

- waste capacity 24 (3 x 8) liters
- technology: full pull-out
- frame/guide silver
- complete lid anthracite
- fitting: cabinet bottom
- **the ideal space saver with an installation height of only 345 mm**

8012088 with bio lid, anthracite

€ 174.48

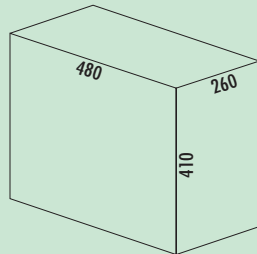

Profiline Trio-Boy® 410 S/300-3

- waste capacity 30 (3 x 10) liters
- technology: full pull-out
- frame/guide silver
- complete lid anthracite
- fitting: cabinet bottom
- **the ideal space saver with an installation height of only 410 mm**

8012089 with bio lid, anthracite

€ 170.79

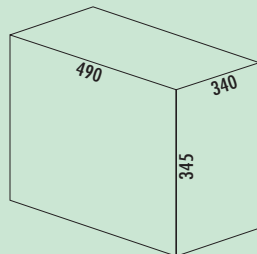

Profiline Double-Master® 345 S/400-2

- waste capacity 32 (2 x 16) liters
- technology: full pull-out
- frame/guide silver
- complete lid anthracite
- fitting: cabinet bottom
- **the ideal space saver with an installation height of only 345 mm**

8012086 anthracite

€ 149.21

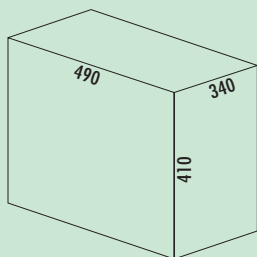

Profiline Double-Master® 410 S/400-2

- waste capacity 40 (2 x 20) liters
- technology: full pull-out
- frame/guide silver
- complete lid anthracite
- fitting: cabinet bottom
- **the ideal space saver with an installation height of only 410 mm**

8012077 anthracite

€ 205.46

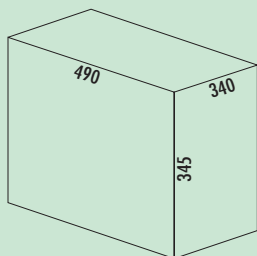

Profiline Trio-Master® 345 S/400-3

- waste capacity 32 (1 x 16/2 x 8) liters
- technology: full pull-out
- frame/guide silver
- complete lid anthracite
- fitting: cabinet bottom
- **the ideal space saver with an installation height of only 345 mm**

8012087 with bio lid, anthracite

€ 178.25

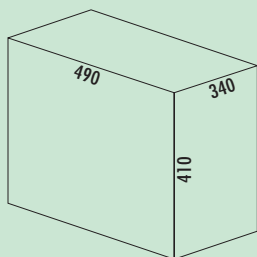

Profiline Trio-Master® 410 S/400-3

- waste capacity 40 (1 x 20/2 x 10) liters
- technology: full pull-out
- frame/guide silver
- complete lid anthracite
- fitting: cabinet bottom
- **the ideal space saver with an installation height of only 410 mm**

8012078 with bio lid, anthracite

€ 205.46

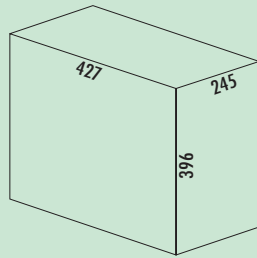

Solo 3635

- waste capacity 20 liters
- technology: full pull-out
- frame/guide silver
- complete lid graphite grey
- fitting: cabinet bottom

8011263 graphite grey

€ 122.00

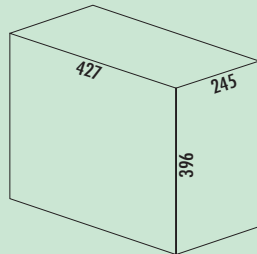

Solo 3636

- incl. cam
- waste capacity 20 liters
- technology: full pull-out incl. cam
- frame/guide silver
- complete lid graphite grey
- fitting: cabinet bottom

8011264 graphite grey

€ 125.77

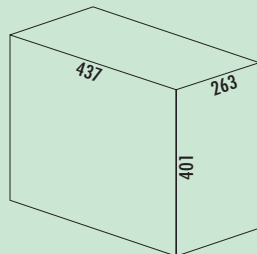

Tandem 8

- waste capacity 26 (2 x 13) liters
- technology: full pull-out
- fitting: cabinet bottom

8011319 dark grey

€ 166.39

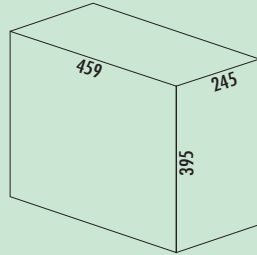

Cleaning agent pullout Carry

Mobile and flexible pull-out.

- carrying baskets can be clipped onto the pull-out system with self-closing mechanism and attenuation – closes gently and quietly
- With the mobile utensils baskets e.g. cleaning agents can be carried to where you need them.
- simple floor mounting

Also for combination with waste separation systems in cabinets from 600 mm.

400 mm MINIMUM CABINET

FULL DRAWER

8011023 light grey

€ 327.46

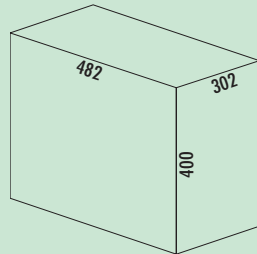

Tandem 7 K

- incl. dustpan set
- waste capacity 30 (2 x 15) liters
- technology: full pull-out
- fitting: cabinet bottom

400 mm MINIMUM CABINET

FULL DRAWER

8011034 light grey

€ 220.47



Tandem S

Built-in waste collector with full pull-out technology for rotating doors, ideal for saving space!

Offers the right model for every requirement:

- for floor cabinets with a width of at least 500 mm
- Ideal space saver with only 350 mm installation height and 330 mm installation depth! Therefore creates space for siphon, water connections and sub-frame equipment.
- quick and easy floor installation

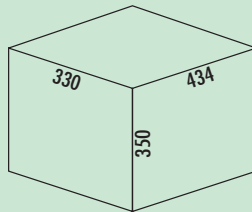
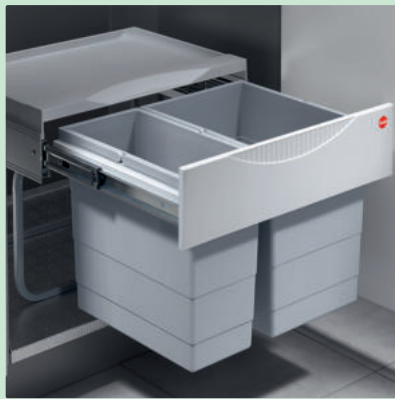

Tandem S 2

- waste capacity 30 (1 x 12/1 x 18) liters
- technology: full pull-out
- fitting: cabinet bottom
- **the ideal space saver with an installation height of only 350 mm and an installation depth of 330 mm**



8011217 light grey

€ 174.48

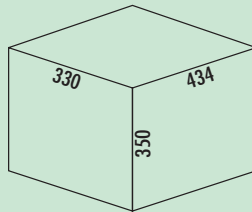

Tandem S 3

- waste capacity 28 (2 x 8/1 x 12) liters
- technology: full pull-out
- fitting: cabinet bottom
- **incl. cover lid for 8 liters bin**
- **the ideal space saver with an installation height of only 350 mm and an installation depth of 330 mm**



8011218 light grey

€ 184.83

SELECTAkit® Pull-out technology for rotating doors

Order no. Description

per piece excl. VAT

Waste collectors

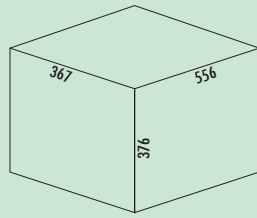

Tandem S 2 plus

- Complete with cam for rotating doors.
- waste capacity 30 (1 x 18/1 x 12) liters
- technology: full pull-out
- fitting: cabinet bottom/side wall (lid)
- **the ideal space saver with an installation height of only 376 mm**

8011219 light grey

€ 246.72

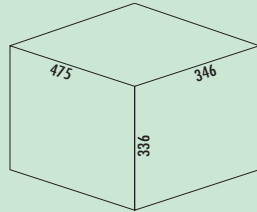

Tandem 4

- waste capacity 36 (2 x 18) liters
- technology: full pull-out
- fitting: cabinet bottom
- **the ideal space saver with an installation height of only 336 mm**

8011157 light grey

€ 203.62

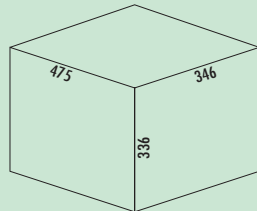

Tandem 5

- Including closing lid for bio waste container.
- waste capacity 34 (2 x 8/1 x 18) liters
- technology: full pull-out
- fitting: cabinet bottom
- **incl. cover lid for 8 litre bin**
- **the ideal space saver with an installation height of only 336 mm**

8011158 light grey

€ 203.62

SELECTAkit® Pull-out technology for rotating doors

Order no. Description

per piece excl. VAT

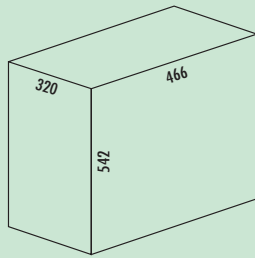

Easy Cargo 1

- waste capacity 42 liters
- technology: full pull-out
- fitting: cabinet bottom



8011254 aluminium grey

€ 269.28

Waste
collectors



Traditionline Master Corner

Advantages:

- two large, detachable, sturdy containers for cleaning agents, with full pull-outs for drawing out
- plastic pans detachable
- simple removal and insertion of the lateral containers possible by swivelling the waste collector

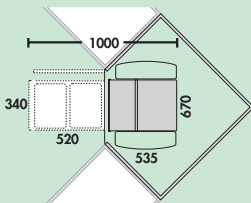
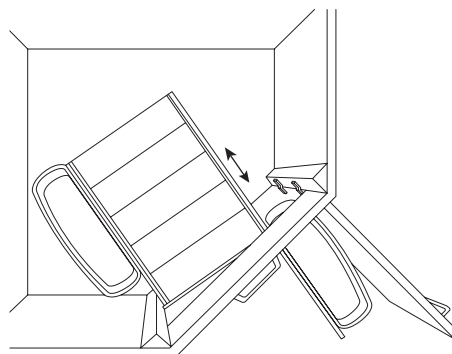

Traditionline Double-Master® Corner 360 S/400-2

Complete with two plastic pans.

For corner cabinets from 900 x 900 mm.

- waste capacity 32 (2 x 16) liters
- technology: full pull-out/swivelling
- frame/guide silver
- complete lid aluminium grey
- minimum door span 380 mm
- fitting: cabinet bottom/rotatable (22° to each side)
- **the ideal space saver with an installation height of only 360 mm**
- **plastic pans may be drawn out**



8012083 aluminium grey

€ 327.46

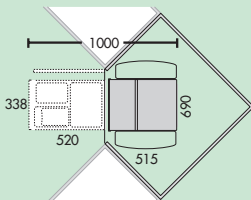

Traditionline Trio-Master® Corner 360 S/400-3

Complete with bio-lid and two plastic pans.

For corner cabinets from 900 x 900 mm.

- waste capacity 32 (2 x 8/1 x 16) liters
- technology: full pull-out/swivelling
- frame/guide silver
- complete lid aluminium grey
- minimum door span 380 mm
- fitting: cabinet bottom/rotatable (22° to each side)
- **the ideal space saver with an installation height of only 360 mm**
- **plastic pans may be drawn out**



8012084 aluminium grey

€ 334.05



Rondo® plus

- for corner cabinets from 900 x 900 mm
- manual pull-out with handle faceplate
- waste bucket optionally for 2-fold, 3-fold or 4-fold separation
- additional lid with handle recess against bothersome odours for one 8 liter organic waste bucket
- telescopic rails on ball bearings glide very easily and ensure full pull-out of the waste bucket
- pans for paraphernalia, for instance for cleaning paraphernalia, the pans may easily be removed for cleaning
- metal parts with high-quality finish

Waste collectors

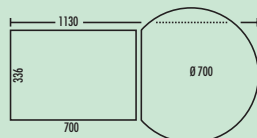

Rondo® 1 plus

For corner cabinets from 900 x 900 mm.

- waste capacity 36 (2 x 18) liters

Extra equipment:

- multi-functional bucket (12 liters) with perforated lid
- 2 pans for paraphernalia
- complete lid with depositing surface
- technology: full pull-out/rotatable
- fitting: cabinet bottom/360° rotatable
- the ideal space saver with an installation height of only 351 mm



8011161 light grey

€ 387.50

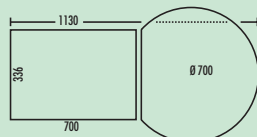

Rondo® 2 plus

For corner cabinets from 900 x 900 mm.

- waste capacity: 34 (1 x 18/2 x 8) liters

Extra equipment:

- multi-functional bucket (12 litres) with perforated lid
- 2 pans for paraphernalia
- complete lid with depositing surface
- technology: full pull-out, rotatable
- fitting: cabinet bottom, 360 ° rotatable
- the ideal space saver with an installation height of only 351 mm



8011162 light grey

€ 398.72

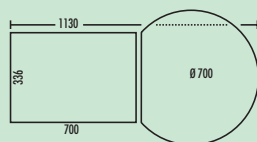

Rondo® 3 plus

For corner cabinets from 900 x 900 mm.

– waste capacity 32 (4 x 8) liters

Extra equipment:

- multi-functional bucket (12 liters) with perforated lid
- 2 pans for paraphernalia
- complete lid with depositing surface
- technology: full pull-out/rotatable
- fitting: cabinet bottom/360° rotatable
- the ideal space saver with an installation height of only 351 mm

8011163 light grey

€ 414.70

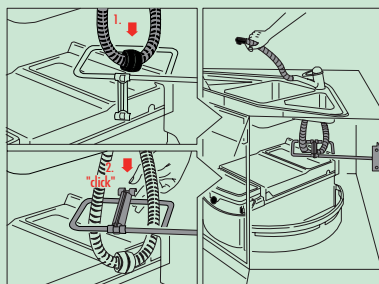

Rondo plus deflector for hoses with shower head

For all common hose fittings with shower head.

- easy installation by screwing to the floor cupboard
- forced routing of the hose in the remaining free spaces, right, left, rear, top
- installed appliances are not impaired in their function
- metal yoke, powder coated with epoxy resin
- optimal accessory for Rondo plus

8011175 white

€ 20.72

SELECTAkit®

Corner solutions



Waste
collectors

Rolling cart DS

Optimum utilisation of space down to the last corner

"How can I use the corners?" is a question some kitchen planners may ask. Especially when every centimetre is precious. You can achieve optimum space usage down to the last corner by employing the rolling cart DS for all rotating door built-in waste collectors and separating systems (see next page). Using the cart, which may be moved all the way back, the spaces to the sides of the waste collector remain accessible and may be used as storage space for cleaning paraphernalia and other items.



Pulled-out position

Pulled-out all the way to the front, the waste collector can be comfortably filled from above.



Parking position

The waste collector takes up very little space in parking position. From this basic position, it may be slid to the front as well as, after shortly lifting it, to the back.



Resting position

Lifting the waste collector releases the lock of the rolling cart. Now, it may be pushed all the way back. The lateral storage spaces are therefore easily accessible.



Waste collectors

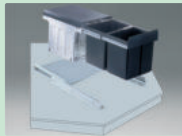
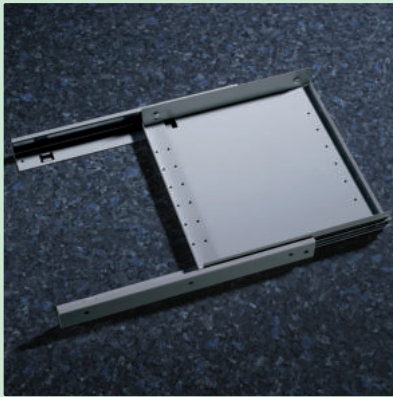

Rolling cart DS

Installation in diagonal corner cabinets with a door span of at least 355 mm. Also suitable for cabinets underneath sinks.
 – 55 x 355 x 410/606 mm (H x W x D)
 – sturdy, powder-coated steel plate

8011136	aluminium grey	€ 78.81
8011134	white	€ 78.81

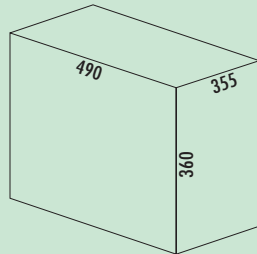

Profiline Double-Master® DS 360 S/400-2

Including rolling cart DS.
 – waste capacity 32 (2 x 16) liters
 – technology: full pull-out
 – frame/guide silver
 – complete lid anthracite
 – the ideal space saver with an installation height of only 360 mm

8010186	anthracite	€ 214.92
---------	------------	----------

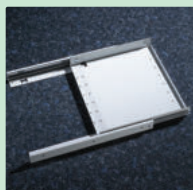
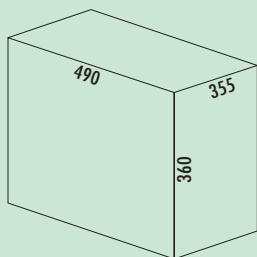

Profiline Trio-Master® DS 360 S/400-3

- Complete with bio-lid, incl. rolling cart DS.
- waste capacity 32 (2 x 8/1 x 16) liters
 - technology: full pull-out
 - frame/guide silver
 - complete lid anthracite
 - **the ideal space saver with an installation height of only 360 mm**

8010187 anthracite

€ 248.08

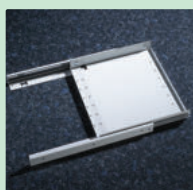
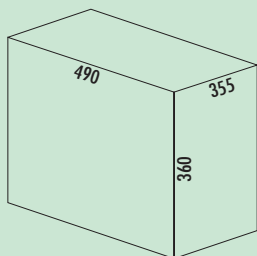

Traditionline Double-Master® DS 360 S/400-2

- Including rolling cart DS.
- waste capacity 32 (2 x 16) liters
 - technology: full pull-out
 - fitting: cabinet bottom
 - **the ideal space saver with an installation height of only 360 mm**

8010111 aluminium grey

€ 205.97

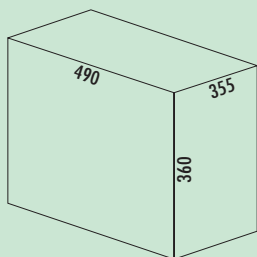

Traditionline Trio-Master® DS 360 S/400-3

- Including rolling cart DS.
- waste capacity 32 (2 x 8/1 x 16) liters
 - technology: full pull-out
 - fitting: cabinet bottom
 - **the ideal space saver with an installation height of only 360 mm**

8010116 aluminium grey

€ 218.42

Optional accessories

8011195 Closing-lid, aluminium grey, for 7, 8, 10 liters

€ 11.41

Waste collectors

Waste
collectors

SELECTAkit®

Swivel technology for rotating doors

The technology of
shorter distances



Waste
collectors

■ Cabbi® junior	Page 235
Cabbi®	Page 236–237
Cox® Beep	Page 238
Müllex Single 35	Page 239
Müllex Euro Flexx	Page 239
Klassikline Single-Junior®	Page 240
Klassikline Single-Junior® Bio	Page 240
Klassikline Double-Junior®	Page 240
Rondo® 2	Page 241
Uno 3418	Page 242
Duo 3416	Page 242

**Suitable for the
following front layouts:**



Full front



Front panel
with one
division

Please check the heights of the product
groups.

SELECTAkit®

Swivel technology for rotating doors

Cabbi® & Cabbi® junior

An intelligent solution with easy handling for collecting organic waste without bothersome odours. A tightly fitting bio-lid with detachable perforated cartridge, which is fitted with an activated charcoal polyester fleece as odour filter.

Overall, the Cabbi® concept is convincing due to its extraordinary quality and a large variety of performance characteristics:

- very sturdy carrying axle construction
- may be easily installed
- optimum use of space
- easy-action cam
- lid with raising/lowering technology
- easy access to the floor cupboard
- clamping strips ensure fixed position
- environmentally compatible basic materials
- convenient wire basket as accessory
- tightly fitting bio-lid

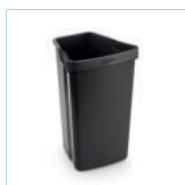

reddot award



Cabbi® & Cabbi® junior are easily installed:



1. Assemble rotating support and pipe support bracket.



2. Complete and insert rotating rods.



3. Install cam.



4. Install basket in rotating bar.

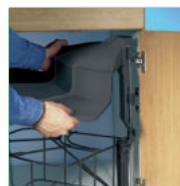

5. Clip lid on.



6. Insert containers.

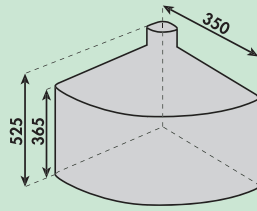

Cabbi® junior 1

- waste capacity 18 liters
- technology: swivel technology
- fitting: cabinet bottom/-wall

8013200 anthracite € 127.26

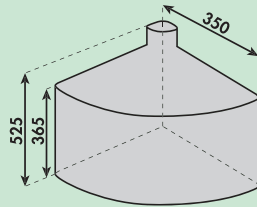

Cabbi® junior 2

- waste capacity 18 (2 x 9) liters
- technology: swivel technology
- fitting: cabinet bottom/-wall

8013201 anthracite € 127.26

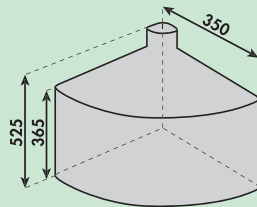

Cabbi® junior 2 plus

Complete with bio-lid and 4 activated charcoal filters (about one year's supply).

- waste capacity 18 (2 x 9) liters
- technology: swivel technology
- fitting: cabinet bottom/-wall

8013202 anthracite € 137.52

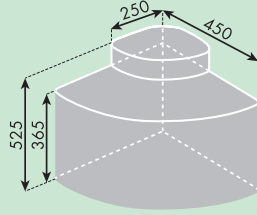

Cabbi® 3

- waste capacity 39 (1 x 18/1 x 9/1 x 12) liters
- technology: swivel technology
- fitting: cabinet bottom/-wall

8013171 anthracite

€ 217.66

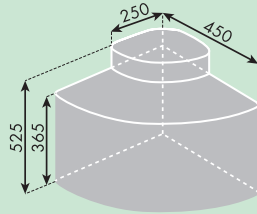

Cabbi® 3 plus

Complete with bio-lid and 4 activated charcoal filters (about one year's supply).

- waste capacity 39 (1 x 18/1 x 9/1 x 12) liters
- technology: swivel technology
- fitting: cabinet bottom/-wall

8013173 anthracite

€ 220.69

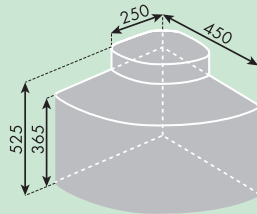

Cabbi® 4

- waste capacity 39 (3 x 9/1 x 12) liters
- technology: swivel technology
- fitting: cabinet bottom/-wall

8013170 anthracite

€ 217.66

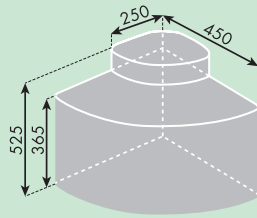

Cabbi® 4 plus

Complete with bio-lid and 4 activated charcoal filters (about one year's supply).

- waste capacity 39 (3 x 9/1 x 12) liters
- technology: swivel technology
- fitting: cabinet bottom/-wall

8013172 anthracite

€ 220.69



Cabbi® bio-lid

Optimal accessories for Cabbi® junior 2, Cabbi® 3 and Cabbi® 4. Including 4 activated charcoal filters (assumed annual requirement).

8011177 for 9 liters

€ 17.12



Bio-filter retrofitting set

Replacement. For Cabbi® junior 2 plus, Cabbi® 3 plus, Cabbi® 4 plus, Cox® Base 360 S/400-2, Cox® Base 360 S/500-3, Cox® Base 360 S/600-3, Cox® Base 360 S/600-4, Cox® Base 360 K, Cox® Base 360 S/900-4, Stand-UP and Cox® Box.

Consisting of 4 activated charcoal filters (assumed annual requirement).

8011178 black

€ 7.71

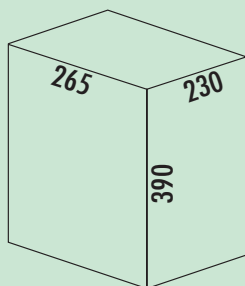

COX® beep

Cox® Beep 400

- waste volume 10 liters
- technology: swivel technology
- lid plastic
- assembly: cabinet bottom/wall
- The cam is attached to the back of the door and is suitable for both frame and panel door mounting.
- can be used right/left

8013002 light grey, H 390 mm, 10 liters **€ 66.10**

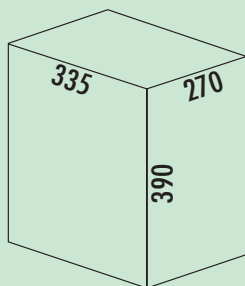

COX® beep

Cox® Beep 450

- waste volume 15.5 liters
- technology: swivel technology
- lid plastic
- assembly: cabinet bottom/wall
- The cam is attached to the back of the door and is suitable for both frame and panel door mounting.
- can be used right/left

8013004 light grey, H 390 mm, 15.5 liters **€ 75.30**

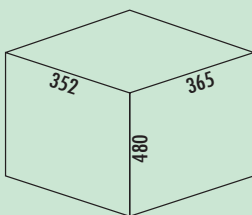

Müllex Single 35

For a lot of rubbish in little space. Container for 35 l standard bags. Bin bag roll and pan, wiper, etc. can be stored practically on the lid. Holding rack with draw hook for swinging out – without straining the hinge fittings.

- waste capacity 35 liters
- technology: full drawer
- complete lid black
- fitting: cabinet bottom and front panel
- max. cabinet width 600 mm

8011020 black

€ 135.16

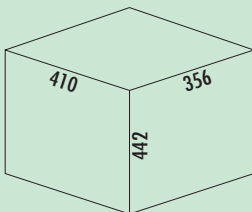

Müllex Euro Flexx

- waste capacity 35 liters
- waste container for 35-l- and 17-l-bags
- technology: swivel technology
- lid with storage recess
- arresting hook prevents strain on the hinges
- fitting cabinet wall, can be mounted left or right

8011030 anthracite

€ 162.37

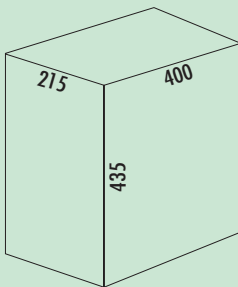

Klassikline Single-Junior®

- waste capacity 19 liters
- technology: swivel technology
- fitting: cabinet wall

8011008	white	€ 77.50
8011085	stainless steel	€ 144.46
8011226	aluminium grey	€ 91.02

Optional accessories

8011016	Bio Boy with separating wall, 5 liters	€ 22.56
----------------	--	---------

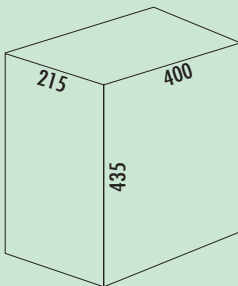

Klassikline Single-Junior® with bio insert

- waste capacity 19 liters incl. 5 l Bio Boy
- technology: swivel technology
- fitting: cabinet wall

8011087	stainless steel	€ 157.63
8011227	aluminium grey	€ 106.02

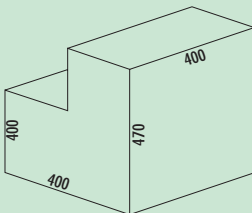

Klassikline Double-Junior®

- waste capacity 29 (1 x 19/1 x 10) liters
- technology: swivel technology
- fitting: cabinet wall

8011088	aluminium grey	€ 167.98
----------------	----------------	----------

Optional accessories

8011016	Bio Boy with separating wall, 5 liters	€ 22.56
----------------	--	---------

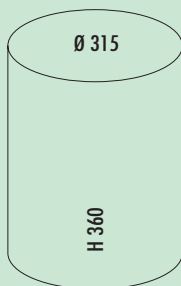

Rondo® 2

- waste capacity 13 liters
- technology: swivel technology
- fitting: cabinet wall
- height 400 mm incl. open lid
- a door opening angle of 110° is required

8011005	stainless steel	€ 76.34
8011006	white	€ 59.28
8011206	silver	€ 59.28

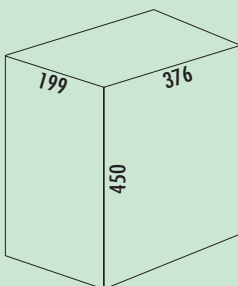

Uno 3418

- waste capacity 18 liters
- technology: swivel technology
- fitting: cabinet wall

8011267	stainless steel	€ 122.00
8011265	white	€ 103.22

Waste
collectors

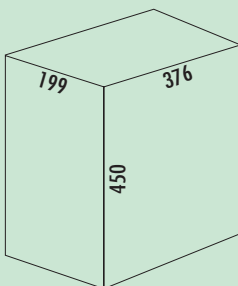

Duo 3416

- waste capacity 16 (2 x 8) liters
- technology: swivel technology
- fitting: cabinet wall

8011270	stainless steel	€ 123.84
8011268	white	€ 105.06

SELECTAkit®

Built-in containers/ Waste disposal units

Extremely practical and shapely



Waste
collectors

■ Dassa

Premium 700 EC

Premium 550 EC

Page 244

Page 245

Page 246

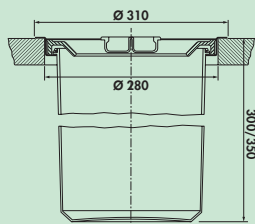

Dassa 2

Quick and handy – installed directly in the working surface.

Also suitable for flush installation.

- installation dimension Ø 280 mm
- outside Ø 310 mm
- waste capacity 13 liters

8011101	stainless steel with plastic insert, waste capacity 11 liters	€ 157.98
8011059	stainless steel with plastic insert, waste capacity 13 liters	€ 215.82

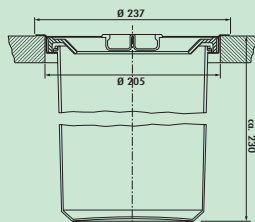

Dassa 4

Quick and handy – installed directly in the working surface.

Also suitable for flush installation.

- installation dimension Ø 205 mm
- outside Ø 237 mm
- waste capacity 5 liters

8011032	stainless steel with aluminium insert	€ 175.44
8011031	stainless steel with plastic insert	€ 133.23



Waste disposal units

- Simple, time-saving cleaning: Food residue is flushed right down the drain with the wastewater.
- Safe and simple operation: have cold water flowing, switch on the device and throw leftovers down the plughole. The disposal device liquefies the leftovers (without knives and blades), which are pressed to the grinding surface of the outside wall by centrifugal force and disintegrated into minute parts by the pressure.
- The disposal device frees the waste bucket of kitchen waste causing disagreeable odours and smeary food residues.
- Disposal of almost all kitchen waste: Even hard bones cannot damage this sturdy device.
- Maintenance-free and self-cleaning: High quality stainless steel and other durable materials. The high-performance motor was developed especially for this disposal device. The disposal device cleans itself through regular use and does not require any chemical cleaning agents.
- **Before installing the waste disposal unit, please contact the competent authorities for information on the regional legal regulations!**

Waste collectors

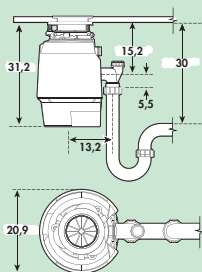

Premium 700 EC

The kitchen waste disposal device may be continuously filled. Automatic change of rotational direction to extend the service life and for trouble-free use. Stainless steel grinding chamber 980 ml, low-noise, with enclosed air break switch in chrome, 2-way grinding process, overload switch with manual reset switch, splash-proof, GS connection, motor with 0.75 hp. Suitable for 3½" drains.

Before installing the waste disposal unit, please contact the competent authorities for information on the regional legal regulations!

- Ø 209 mm
- weight 8.12 kg
- 380 watt

8012031 anthracite, H 312 mm

€ 1,435.00

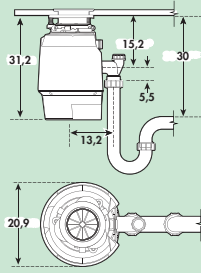

Premium 550 EC

Kitchen waste disposer with 2-Stage MultiGrind technology, can be filled continuously. Food residues are crushed into small particles and washed away in seconds. Durable and compact built-in household solution under the sink, without loss of valuable storage space.

The Lift & Latch technology allows for easy installation in new or existing kitchens and is compatible with most sinks. Motor with 0.55 hp, stainless steel grinding elements and integrated air switch in chrome. Overload protection. Suitable for 3½" drains.

Before installing the waste disposal unit, please contact the competent authorities for information on the regional legal regulations!

- Ø 209 mm
- weight 8.12 kg
- grinding chamber capacity 980 ml
- drain connection 380 mm
- 380 watts

8012034 anthracite, H 312 mm

€ 900.49