

STOREX®

Cabinet
equipment



Overview

Cabinet
equipment



Organisation systems that kitchens simply can't do without! With the clearly structured storage solutions of the STOREX® kitchen cabinet equipment, everything you need is well-organised and right at hand. In the kitchen, in the utility room, in the pantry, and even in the bathroom, the office and the workshop!

At the same time, each individual item stands for consistently secure and purposeful handling – so that things are always exactly where they should be. Drawers are used, cupboard pull-outs are opened, containers are picked up and filled. The rich spectrum of design elements offers a wealth of organised flexibility. The space available for storage is fully utilised, even hard-to-reach heights are accessed with flexible lift fittings.

STOREX® is at home wherever things need to be retrieved from or stowed in base cabinets, wall cabinets or tall cabinets. For quick and convenient organisation and separation at your fingertips!

STOREX®

Cabinet equipment

Well thought out and
engineered



STOREX® Equipment for base units
For space saving solutions Page 510–566

STOREX® Equipment for wall mounted
cabinets
Everything in its place Page 567–578

STOREX® Equipment for tall cabinets
Convenient and
easy access Page 579–592

STOREX® Accessories
Things you always need Page 593–602

STOREX®

Equipment for base units

Space saving solutions



- Drawer inserts**
Flexible and adaptable Page 513–530
- Pullouts for base units**
Exploited to the full Page 531–548
- HOLDERS and hooks**
Most welcome Page 549–554
- Built-in appliances for drawers**
Concealed and immediately good to go Page 555–560
- Base built-in devices**
Creative solutions to special challenges Page 561–566

STOREX® Drawer inserts

Flexible and adaptable



Drawer system Modify	Page 515–521
Cutlery insert Cuisio	Page 522–524
Schubladeneinsatz Cuisio Flex	Page 525
Cutlery insert Kvalito	Page 526
Cutlery insert Adesso	Page 527
Further cutlery inserts	Page 528–529
Water protection and anti-slide mats	Page 530

STOREX® Cutlery inserts

Frame system	BLUM Tandembox	BLUM Legrabox	Hettich ArciTech	GRASS Nova pro
Manufacturers	Nobia Group (SWE), DanKitchens (AT), JAKA-BKL, Impuls Kitchens, Alno AG, Pino-Kitchens, alma Kitchens, Nieburg Kitchens, Bauformat Kitchens, Beckmann Kitchens, Schröder Kitchens, rwk Built-in kitchens, burger Kitchens, EWE-Kitchens (AT) ¹ , Störmer Kitchens2	Schüller Kitchens, Warendorfer Kitchens (Störmer Kitchens, Ballerina Kitchens)	Nobilis-Werke, pronorm Built-in kitchens, Brigitte Kitchens, Beeck Kitchens, Express Kitchens, Nolte	Häcker Kitchens, SA Fournier (FR), Leicht Kitchens, Eggersmann Kitchens, Bax Küchenmanufaktur, SachsenKitchens, Rabe & Meyer, Ballerina Kitchens2, Zeyko, rotpunkt
	(Nominal depth – 27 mm) x (Cabinet width – 82 mm)	(Nominal depth – 27 mm) x (Cabinet width – 73 mm)	(Nominal depth – 27 mm) x (Nominal width – 106 mm)	(Nominal depth – 20 mm) x (Cabinet width – 90 mm)
Modify	✓	✓	✓	✓ (with compensation strip 8035038)
Cuisio	✓	does not entirely fill the drawer	only suitable for Nobilia	✓
Ordine	✓	✓		✓
Adesso 1			✓	
Adesso 2	✓	✓		✓
Cutlery insert 1	✓	✓		✓
Cutlery insert 2	✓	✓		✓
Multipurpose insert	✓	✓		✓
Cutlery insert 4	✓			
Cutlery insert 5				✓
Spice jar insert	✓	✓		✓
Cutlery insert Smart	✓	✓		✓

¹ EWE Kitchen: uses 18 gauge sides. I.e. standard dimensions BLUM Tandembox are 4 mm too wide!

² Störmer Kitchen/Ballerina Kitchen: kitchen furniture manufacturers use various frame systems. BLUM Legrabox is for in high quality range! Siematic Kitchen uses GRASS VIONARO (conversion at trade fair M.O.W. 2014) – Cutlery insert dimensions correspond to BLUM Legrabox.

All specifications are non-binding, subject to change.

STOREX®

Modify Drawer system



The innovation in the kitchen

The Naber Modify drawer equipment system, designed for drawers with a depth of 472 mm or 572 mm incl. depth supplement, offers a variety of employment and extension options. Thanks to the clever system with equipment elements, drawers and pull-outs can be divided as needed. This flexibility makes Modify a real all-rounder among the drawer equipment systems.

The modules made of real wood are characterised by high-quality materials and excellent workmanship, giving every drawer an individual division structure. By means of continuous horizontal movement of the different elements, for example, sections of any size can be formed, enabling individual storage of various kitchen accessories.

Thanks to the use of non-slip mats on the drawer base, it is not necessary to fully equip the drawer with inserts. Here, the system manages with a few premium manufactured components and provides functional accessories for your daily needs. It is flexible in width and solves the problem of connection to drawer frames without a vertical inner profile.

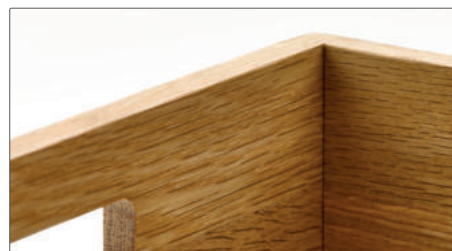

Bright oak, varnished



Ash-tree black, varnished

Variable dividers made of powder coated metal in graphite colours



STOREX®

Modify Drawer system



The innovation in the kitchen

All the advantages at a glance:

- dominant material: solid bright oak, varnished, ash-tree black, varnished
- focus on functionality
- diverse combinations & extensions possible
- comprehensive organisation solutions
- no compensating elements necessary
- designed for drawer depth of 472 mm or 572 mm incl. depth supplement

Components: boxes, cutlery insert, trays etc.



Additional special elements

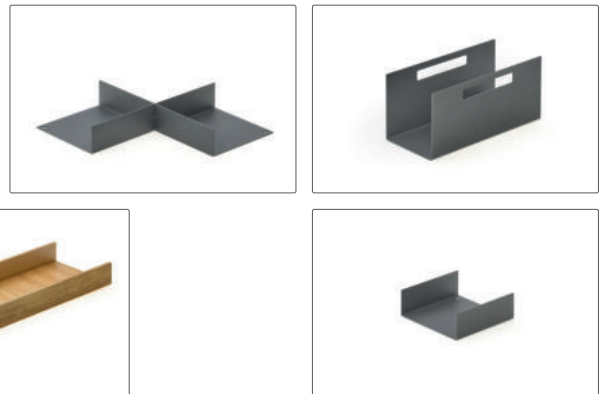

Components and special elements in combination





Modify set 800/900

Suitable for 800 mm and 900 mm drawer.
 Set consisting of:
 – 1 Modify cutlery insert (8035021/8035121)
 – 4 Modify trays (8035022/8035122)
 – 1 Modify non-slip mat (8035040)

8035050 bright oak	€ 259.64
8035150 ash-tree black	€ 259.64



Modify set 1000

Suitable for 1000 mm drawer.
 Set consisting of:
 – 1 Modify cutlery insert (8035021/8035121)
 – 4 Modify trays (8035022/8035122)
 – 1 Modify multifunctional insert (8035020/8035120)
 – 1 Modify film holder (8035023/8035123)
 – 1 Modify non-slip mat (8035040)

8035051 bright oak	€ 386.49
8035151 ash-tree black	€ 386.49



Modify set 1200

Suitable for 1200 mm drawer.
 Set consisting of:
 – 1 Modify cutlery insert (8035021/8035121)
 – 4 Modify trays (8035022/8035122)
 – 1 Modify multifunctional insert (8035020/8035120)
 – 1 Modify knife insert (8035024/8035124)
 – 1 Modify non-slip mat (8035040)

8035052 bright oak	€ 408.91
8035152 ash-tree black	€ 408.91



Modify cutlery insert

– 43 x 300 x 472 mm (H x W x D)

8035021	bright oak	€ 96.55
8035121	ash-tree black	€ 96.55



Modify depth supplement

Suitable for oversized drawers. May be cut to size.
– 43 x 100 mm (H x D)

8035041	bright oak, W 600 mm	€ 73.03
8035042	bright oak, W 1200 mm	€ 99.18
8035141	ash-tree black, W 600 mm	€ 73.03
8035142	ash-tree black, W 1200 mm	€ 99.18



Modify bowl

– 43 x 117.5 x 300 mm (H x W x D)

8035022	bright oak	€ 37.21
8035122	ash-tree black	€ 37.21

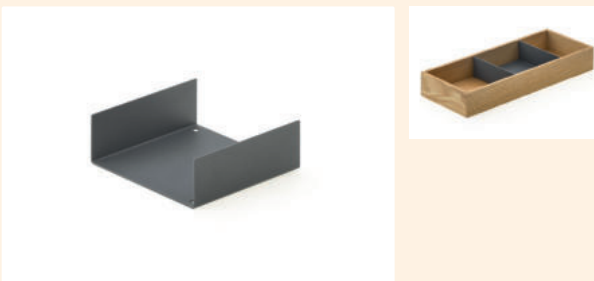

Modify U-divider

Metal, powder-coated. Suitable for tray (8035022).
– 38 x 111 x 104.5 mm (H x W x D)

8035033	graphite	€ 24.57
----------------	----------	---------



Modify multifunctional insert

Also suitable for film insert (8035023/8035123), knife insert (8035024/8035124), spice jar insert (8035025/8035125), spice inlay (8035026/8035126) and insert cross (8035027/8035127).
– 43 x 150 x 472 mm (H x W x D)

8035020	bright oak	€ 50.20
8035120	ash-tree black	€ 50.20



Modify film insert

With 2 lids aluminium and intermediate piece. Without films.
– 37.5 x 137.5 x 472 mm (H x W x D)

Multifunctional insert (8035020/8035120) order separately.

8035023	bright oak	€ 73.90
8035123	ash-tree black	€ 73.90

Cabinet equipment



Modify knife insert

– 26 x 137.5 x 472 mm (H x W x D)

Multifunctional insert (8035020/8035120) order separately.

8035024 bright oak	€ 96.55
8035124 ash-tree black	€ 96.55



Modify spice jar insert

With 6 sections Ø 60 mm, without spice jars.

– 8 x 137.5 x 472 mm (H x W x D)

Multifunctional insert (8035020/8035120) order separately.

8035025 bright oak	€ 56.87
8035125 ash-tree black	€ 56.87



Modify spice inlay

Slanted.

– 26 x 137.5 x 472 mm (H x W x D)

Multifunctional insert (8035020/8035120) order separately.

8035026 bright oak	€ 53.54
8035126 ash-tree black	€ 53.54



Modify insert cross

– 37.5 x 137.5 x 472 mm (H x W x D)

Multifunctional insert (8035020/8035120) order separately.

8035027 bright oak	€ 35.72
8035127 ash-tree black	€ 35.72



Modify compensation strip

For deep drawers.

– 43 x 8 mm (H x D)

8035038 up to 1200 mm cabinet, bright oak	€ 41.70
8035138 up to 1200 mm cabinet, ash-tree black	€ 41.70

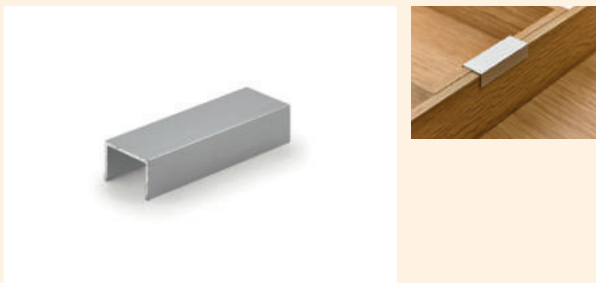

Modify clip

For additional connection of the inserts.

– 9 x 14 x 40 mm (H x W x D)

8035028 aluminium anodised	€ 2.98
-----------------------------------	--------



Modify anti-slide mat

May be cut to size. Black.

8035039	up to 600 mm cabinet, W 530, D 473 mm	€ 11.24
8035040	up to 1200 mm cabinet, W 1130, D 473 mm	€ 20.89



Modify box

Also in the pull-out, the flexible concept of Modify is consistently implemented. Horizontal sliding boxes in three sizes allow optimum use of the storage space. Due to the different dimensions of the boxes, these can, for example, be stacked to save space. Ergonomically designed handles provide for optimum handling of the boxes. Various divisions made of powder-coated metal round off the accessories range for the boxes.



Modify box 1

– 110 x 236 x 472 mm (H x W x D)

8035029	bright oak	€ 157.10
8035129	ash-tree black	€ 157.10

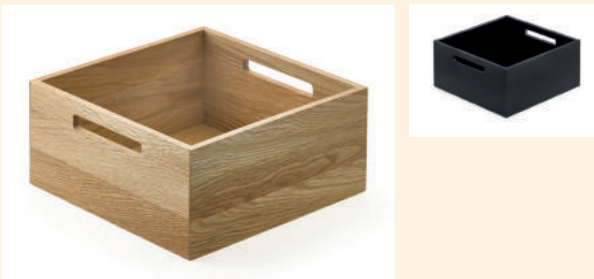

Modify box 2

– 110 x 236 x 236 mm (H x W x D)

8035030	bright oak	€ 100.06
8035130	ash-tree black	€ 100.06



Modify U-divider with handle

Metal, powder-coated. Suitable for Box 1 (8035029/8035129) and 2 (8035030/8035130).

– 102 x 99 x 219 mm (H x W x D)

8035035	graphite	€ 42.40
----------------	----------	---------

Cabinet equipment



Modify box 3

– 43 x 236 x 236 mm (H x W x D)

8035031 bright oak € 50.03

8035131 ash-tree black € 50.03



Modify cross

Metal, powder-coated. Suitable for Box 3 (8035031/8035131).
– 38 x 223 x 223 mm (H x W x D)

8035034 graphite € 50.03



Modify box 4

– 90 x 117.5 x 300 mm (H x W x D)

8035032 bright oak € 69.78

8035132 ash-tree black € 69.78



Modify anti-slide mat

May be cut to size. Black.

8035039 up to 600 mm cabinet, W 530, D 473 mm € 11.24

8035040 up to 1200 mm cabinet, W 1130, D 473 mm € 20.89



Cutlery insert Cuisio

- White and graphite translucent plastic in connection with **aluminium profiles** emanate high quality.
- May be employed for all grid widths from 300 mm and for all drawer makes.
- Individual subdivision options due to flexible dividing strips.
- easy to clean
- The different widths are supplied preassembled.
- height 55 mm
- Can be used for all grid widths from 300 mm and is suitable for the ArciTech frame (Nobilia) by shortening the rear seal to the total width of the insert and thus eliminating the lateral sealing lips.

Simple assembly.
Dividing strips may be flexibly positioned and plugged onto aluminium profiles – finished!

Cabinet equipment



Cuisio 30

Cutlery insert. For 300 mm drawer width. White translucent with aluminium profile and graphite translucent with stainless-steel coloured profile. Consisting of 1 x 200 mm bowl incl. subdivisions.

- W min./max. 195/220 mm
- D min./max. 463/480 mm

8034090	white translucent	€ 46.86
8034215	graphite translucent	€ 46.86



Cuisio 40

Cutlery insert. For 400 mm drawer width. White translucent with aluminium profile and graphite translucent with stainless-steel coloured profile. Consisting of 1 x 200 mm bowl and 1 x 100 mm bowl incl. subdivisions and profile.

- W min./max. 295/320 mm
- D min./max. 463/480 mm

8034091	white translucent	€ 67.14
8034216	graphite translucent	€ 67.14



Cuisio 45

Cutlery insert. For 450 mm drawer width. White translucent with aluminium profile and graphite translucent with stainless-steel coloured profile. Consisting of 1 x 200 mm bowl and 1 x 150 mm bowl, incl. subdivisions and profile.

- W min./max. 345/370 mm
- D min./max. 463/480 mm

8034092 white translucent € 70.48

8034217 graphite translucent € 70.48



Cuisio 50

Cutlery insert. For 500 mm drawer width. White translucent with aluminium profile and graphite translucent with stainless-steel coloured profile. Consisting of 1 x 200 mm bowl and 2 x 100 mm bowls, incl. subdivisions and profile.

- W min./max. 395/420 mm
- D min./max. 463/480 mm

8034093 white translucent € 89.52

8034218 graphite translucent € 89.52



Cuisio 60

Cutlery insert. For 600 mm drawer width. White translucent with aluminium profile and graphite translucent with stainless-steel coloured profile. Consisting of 1 x 600 mm insert, divided into 1 x 200 mm bowl and 2 x 150 mm bowls, incl. subdivisions and profile.

- W min./max. 495/520 mm
- D min./max. 463/480 mm

8034094 white translucent € 97.76

8034219 graphite translucent € 97.76



Cuisio 80

Cutlery insert. For 800 mm drawer width. White translucent with aluminium profile and graphite translucent with stainless-steel coloured profile. Consisting of 1 x 600 mm insert and 2 x 100 mm inserts, divided into 1 x 200 mm bowl, 2 x 150 mm bowls and 2 x 100 mm bowls incl. subdivisions and profile.

- W min./max. 695/720 mm
- D min./max. 463/480 mm

8034095 white translucent € 145.70

8034220 graphite translucent € 145.70



Cuisio 90

Cutlery insert. For 900 mm drawer width. White translucent with aluminium profile and graphite translucent with stainless-steel coloured profile. Consisting of 1 x 600 mm insert and 2 x 150 mm inserts, divided into 1 x 200 mm bowl and 4 x 150 mm bowls incl. subdivisions and profile.

- W min./max. 795/820 mm
- D min./max. 463/480 mm

8034096 white translucent € 150.43

8034221 graphite translucent € 150.43



Cuisio 100

Cutlery insert. For 1000 mm drawer width. White translucent with aluminium profile and graphite translucent with stainless-steel coloured profile. Consisting of 1 x 600 mm insert, 2 x 150 mm inserts and 1 x 100 mm insert, divided into 1 x 200 mm bowl, 4 x 150 mm bowls and 1 x 100 mm bowl incl. subdivisions and profile.

- W min./max. 895/920 mm
- D min./max. 463/480 mm

8034097 white translucent € 184.31

8034222 graphite translucent € 184.31

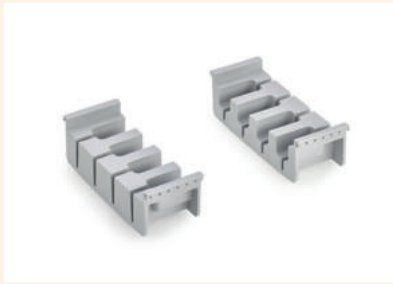

Cuisio knife insert

Grey, consisting of two blocks.

8034059 for 100 mm bowl	€ 14.66
8034060 for 150 mm bowl	€ 16.41

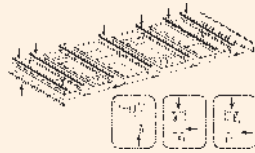

Cuisio dividing strips/side end 2

White translucent.

8034114 dividing strips, for 100 mm bowl	€ 2.38
8034115 dividing strips, for 150 mm bowl	€ 2.89
8034116 dividing strips, for 200 mm bowl	€ 2.27
8034117 side end	€ 14.66



Cuisio dividing strips/side end 3

Graphite translucent.

8034227 dividing strips, for 100 mm bowl	€ 2.38
8034228 dividing strips, for 150 mm bowl	€ 2.89
8034229 dividing strips, for 200 mm bowl	€ 2.27
8034230 side end	€ 14.66



Cuisio 60 G

Cutlery insert with spice insert. For 600 mm drawer width. White translucent with aluminium profile and graphite translucent with stainless-steel coloured profile.

Consisting of 1 x 200 mm bowl and 1 x 300 mm spice pot insert.

- W min./max. 495/520 mm
- D min./max. 463/480 mm

8034101 white translucent	€ 100.93
8034106 graphite translucent	€ 100.93



Cuisio 80 G

Cutlery insert with spice insert. For 800 mm drawer width. White translucent with aluminium profile and graphite translucent with stainless-steel coloured profile. Consisting of 1 x 200 mm bowl, 2 x 100 mm bowls and 1 x 300 mm spice pot insert.

- W min./max. 695/720 mm
- D min./max. 463/480 mm

8034102 white translucent	€ 148.60
8034107 graphite translucent	€ 148.60

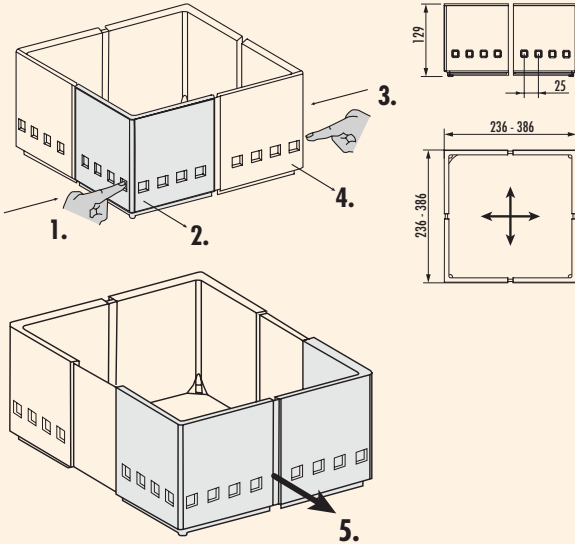

Tray insert Cuisio Flex

Dividing strip.

- progressively adjustable in two directions
- flexible placement in the pull-out with simultaneous creation of further storage space
- Anti-slide plugs guarantee secure stand on the surface.
- only one item is required for fitting all pull-out widths, because independent of width
- corners colour-painted white and black, central part white and graphite-translucent
- **available in three set variants**

8034064	2-part set white translucent, corners white	€ 119.46
8034065	3-part set white translucent, corners white	€ 168.25
8034066	4-part set white translucent, corners white	€ 214.33
8034224	2-part set graphite translucent, corners black	€ 119.46
8034225	3-part set graphite translucent, corners black	€ 168.25
8034226	4-part set graphite translucent, corners black	€ 214.33

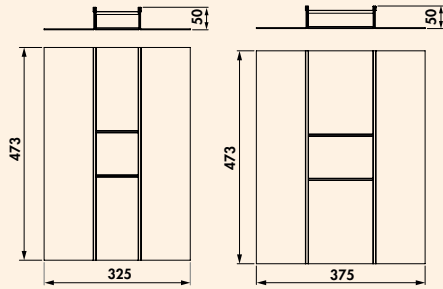

Cutlery insert Kvalito

Cutlery insert.

- anthracite flocking
- water-repellent
- edge can be cut
- **H 48 mm**
- min./max. widths and depths, see dimensional drawings
- modular for use with all drawer systems
- incl. dividers and profile

8034287	for 400 mm cabinet, anthracite	€ 124.79
8034288	for 450 mm cabinet, anthracite	€ 127.31

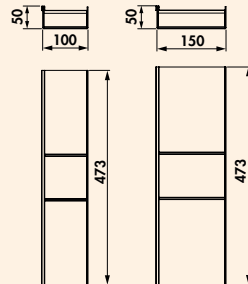

Kvalito supplementary bowl

Supplementary set.

- anthracite flocking
- water-repellent
- edge can be cut
- **H 48 mm**
- min./max. widths and depths, see dimensional drawings
- modular for use with all drawer systems
- including divider and profile

8034289	100 mm, anthracite	€ 59.24
8034290	150 mm, anthracite	€ 62.61



Cutlery insert Adesso

The design of this straightforward organizational talent is the perfect choice for today's modern kitchens. The compartment divisions with their continuous lines fit in harmoniously with the design of the rail systems.

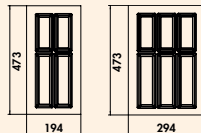

Adesso 1

Cutlery insert suitable for Hettich ArciTech Zarge (Nobilia, Pronorm, Brigitte Kitchens, express Kitchens).

- colour grey
- widths and depths see dimension drawings
- H 50.5 mm

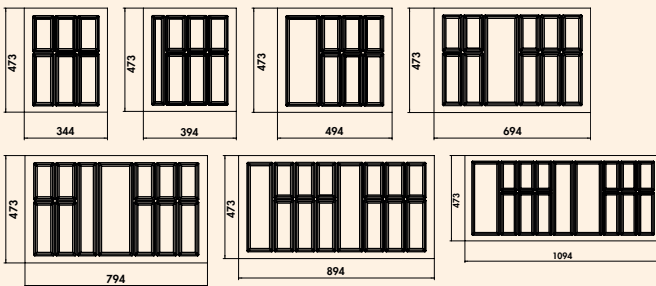

8034264	for 300 mm cabinet	€ 15.37
8034265	for 400 mm cabinet	€ 16.07
8034266	for 450 mm cabinet	€ 17.64
8034267	for 500 mm cabinet	€ 20.02
8034268	for 600 mm cabinet	€ 25.10
8034269	for 800 mm cabinet	€ 30.54
8034270	for 900 mm cabinet	€ 43.53
8034271	for 1000 mm cabinet	€ 50.65
8034272	for 1200 mm cabinet	€ 55.30



Adesso 2

Cutlery insert.

- colour black matt
- edge cuttable
- min./max. widths and depths see dimension drawings
- H 50.5 mm

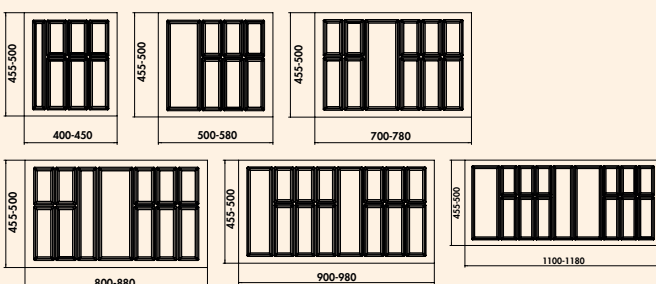

8034274	for 400 mm cabinet	€ 17.20
8034275	for 450 mm cabinet	€ 18.00
8034276	for 500 mm cabinet	€ 19.32
8034277	for 600 mm cabinet	€ 22.91
8034278	for 800 mm cabinet	€ 42.83
8034279	for 900 mm cabinet	€ 49.49
8034280	for 1000 mm cabinet	€ 58.19
8034281	for 1200 mm cabinet	€ 73.11

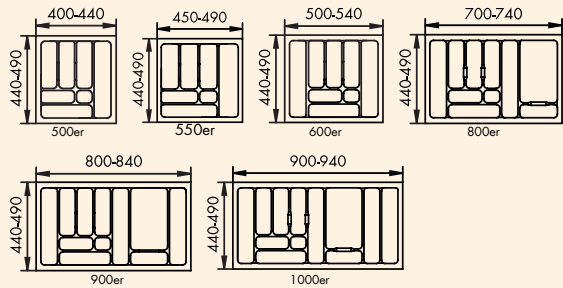
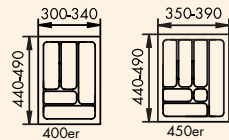

Cutlery insert 1

- colour grey
- edge cuttable
- min./max. widths and depths see dimension drawings
- H 50 mm

8034125	for 400 mm cabinet	€ 15.80
8034126	for 450 mm cabinet	€ 16.77
8034127	for 500 mm cabinet	€ 18.16
8034128	for 550 mm cabinet	€ 20.62
8034129	for 600 mm cabinet	€ 21.85
8034130	for 800 mm cabinet	€ 37.83
8034131	for 900 mm cabinet	€ 44.05
8034132	for 1000 mm cabinet	€ 52.49

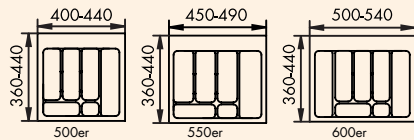
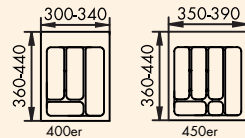

Cutlery insert 2

- colour grey
- edge cuttable
- min./max. widths and depths see dimension drawings
- H 50 mm

8034120	for 400 mm cabinet	€ 31.07
8034121	for 450 mm cabinet	€ 31.33
8034122	for 500 mm cabinet	€ 33.26
8034123	for 550 mm cabinet	€ 36.69
8034124	for 600 mm cabinet	€ 38.01

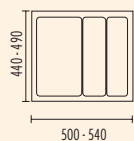
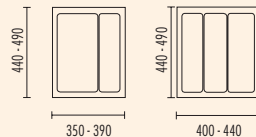

Multi-purpose insert

- Cutlery insert. For accomodating large kitchen appliances.
- colour grey
 - edge cuttable
 - min./max. widths and depths see dimension drawings
 - H 50 mm

8034134	for 450 mm cabinet	€ 20.81
8034135	for 500 mm cabinet	€ 21.59
8034136	for 600 mm cabinet	€ 23.44

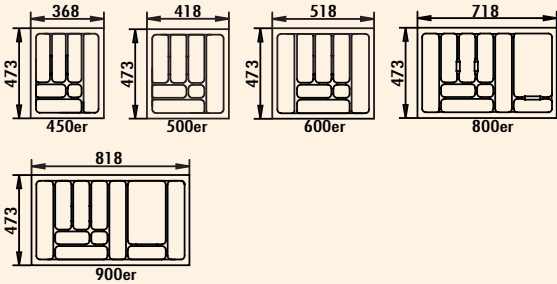
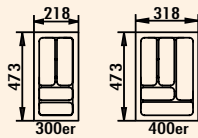

Cutlery insert 4

Suitable for Blum Tandembox (Alno, Pino, Impuls, Beckermann Kitchens, bauformat, Störmer Kitchens, Schröder Kitchens, ewe Kitchens, rwk Einbauküchen, burger Kitchens).

- colour silver-grey
- H 50 mm

8030008	for 300 mm cabinet, W 218, D 473 mm	€ 14.92
8030009	for 400 mm cabinet, W 318, D 473 mm	€ 14.92
8030010	for 450 mm cabinet, W 368, D 473 mm	€ 16.24
8030011	for 500 mm cabinet, W 418, D 473 mm	€ 18.87
8030012	for 600 mm cabinet, W 518, D 473 mm	€ 22.73
8030002	for 800 mm cabinet, W 718, D 473 mm	€ 39.32
8030007	for 900 mm cabinet, W 818, D 473 mm	€ 47.48

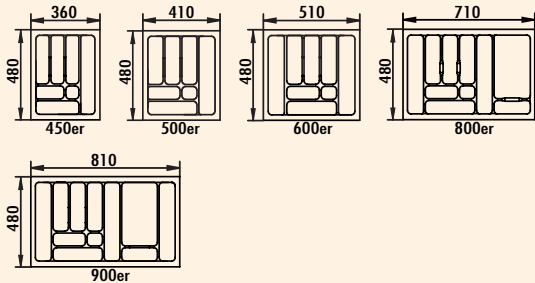
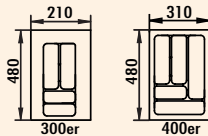

Cutlery insert 5

Suitable for Grass Nova Pro (Leicht, Häcker, Zeyko, rotpunkt, Ballerina Kitchens, Sachsen Kitchens).

- colour silver-grey
- H 50 mm

8034255	for 300 mm cabinet, W 210, D 480 mm	€ 14.92
8034256	for 400 mm cabinet, W 310, D 480 mm	€ 14.92
8034257	for 450 mm cabinet, W 360, D 480 mm	€ 16.24
8034258	for 500 mm cabinet, W 410, D 480 mm	€ 18.87
8034259	for 600 mm cabinet, W 510, D 480 mm	€ 22.73
8034260	for 800 mm cabinet, W 710, D 480 mm	€ 39.32
8034261	for 900 mm cabinet, W 810, D 480 mm	€ 47.48

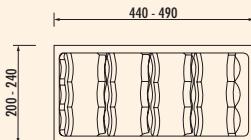

Spice pot insert

For 300 mm drawers. For spice pots in 12-part set; small or large pots may be used. Pots are inserted aslant.

- colour silver-grey
- edge may be shortened
- H 50 mm

8034069	W 240, D 490 mm	€ 28.52
----------------	-----------------	---------



Water protection mat Protect

- Maximum safety: Protect is a closed system which provides maximum safety in case the siphon or containers leak, and thus protects the sink body against serious damage (swelling).
- Best cleaning properties: Protect is designed so that the system can be removed from the sink body at any time for cleaning or replacement.
- Best solution for the environment: Protect is made of recyclable polystyrene.

8034232	for 500 mm cabinet, W 462, D 580 mm	€ 22.64
8034233	for 600 mm cabinet, W 562, D 580 mm	€ 24.32



Anti-slide mat 1

For pull-outs and carousel plates, colour: grey. Due to the great stability, crockery and pots no longer slide. Made of high-quality synthetic rubber with rhombus pattern surface, may be easily taken out for cleaning.

8034014	for 500 mm cabinet, W 450, D 500 mm	€ 10.27
8034015	for 600 mm cabinet, W 550, D 500 mm	€ 11.67
8034016	for 800 mm cabinet, W 750, D 500 mm	€ 18.43
8034017	for 900 mm cabinet, W 850, D 500 mm	€ 21.15
8034019	rolled good, grey, W 500 mm, 5 RM	€ 111.12



Anti-slide mat 2

- For pull-outs.
- can be cut to size
 - may be easily taken out for cleaning

8012352	up to 600 mm cabinets, W 500, D 480 mm, light grey	€ 12.46
8012353	up to 1200 mm cabinets, W 1100, D 480 mm, light grey	€ 24.76
8013352	up to 600 mm cabinets, W 500, D 480 mm, anthracite	€ 12.46
8013353	up to 1200 mm cabinets, W 1100, D 480 mm, anthracite	€ 24.76

STOREX®

Pullouts for base units

Exploited to the full



■ Cornerstone Swing	Page 532–533
■ Cornerstone Maxx	Page 534–535
■ VS COR Fold	Page 536–537
■ VS COR Wheel Pro	Page 538
■ VS SUB Slim	Page 539–540
■ VS SUB Side	Page 541
■ Internal pull-outs	Page 542
■ SpaceFlexx Set	Page 542
■ TopFlex pull-out table	Page 543
■ ChefsTable	Page 544
■ Laundry pull-outs	Page 545–548



Cornerstone Swing

Cornerstone Swing moves the contents in front of the cabinet, thus opening up new perspectives. The trays are positioned well in front of the cabinet body, providing optimum accessibility. The trays can be mounted at different heights, and the lower shelf swings out automatically when the door is opened.

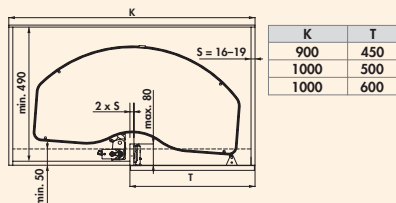

Cornerstone Swing set

Corner cupboard swivel fitting for accommodating shelves.

- for 900 mm cabinet width and 450 mm door width
- for 1000 mm cabinet width and 500 or 600 mm door width
- installation depth min. 490 mm
- telescopic up to 40 mm
- swivels out to the right or left
- swivel technology that slides straight out, no obstruction of the adjacent cabinet

Set consisting of:

- standpipe
- 2 x swivel arm
- pipe fixture above
- 2 x mount for shelf

Please note:

Shelves need to be ordered separately!

8037172	installation height 651–690 mm, silver	€ 292.27
8037171	installation height 610–650 mm, silver	€ 289.63
8037173	installation height 691–730 mm, silver	€ 294.02
8037174	installation height 731–770 mm, silver	€ 295.77

Cornerstone Swing soft-closing set

The top shelf closes automatically and silently thanks to a self-closing mechanism with damping.

8037175	grey	€ 36.85
----------------	------	---------

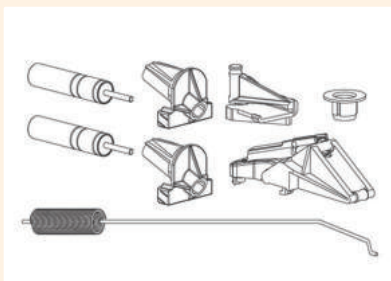

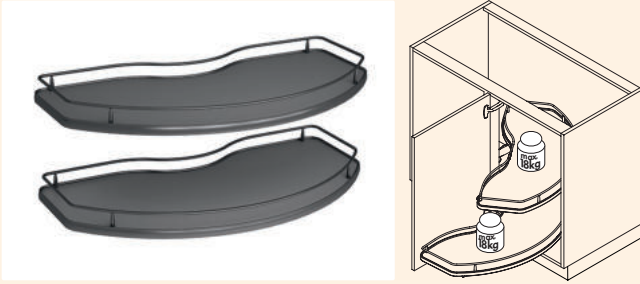

Cornerstone Swing shelf set

Storage elements for corner cupboard swivel fitting Cornerstone Swing.

- symmetrical shelf for mounting on the right and left
- for 900 mm cabinet width and 450 mm door width
- for 1000 mm cabinet width and 500 or 600 mm door width
- installation depth min. 490 mm
- door opening angle 90° so that shelves can slide out fully
- shelf variant 2/4
- load capacity max. 18 kg per shelf
- simple height adjustment of the shelves
- shelves that slide straight out: no obstruction of the adjacent cabinet
- shelves can be swivelled in and out independently of each other
- rail silver, shelf grey, thickness 16 mm
- rail anthracite, shelf anthracite, thickness 16 mm

Set consisting of:

- 2 x 2/4 shelf

Please note:

Cornerstone Swing corner cupboard swivel fitting needs to be ordered separately!

8037176	900 mm cabinet, 450 mm door, silver	€ 179.93
8037177	900 mm cabinet, 450 mm door, anthracite	€ 179.93
8037178	1000 mm cabinet, 500 mm door, silver	€ 188.70
8037179	1000 mm cabinet, 500 mm door, anthracite	€ 188.70
8037180	1000 mm cabinet, 600 mm door, silver	€ 201.87
8037181	1000 mm cabinet, 600 mm door, anthracite	€ 201.87



Cornerstone Maxx

The Cornerstone Maxx convinces with shelves that slide straight out and a floating design with sturdy shelf areas. It enables direct access to the complete shelf content – without obstructing access to the adjoining cabinet.

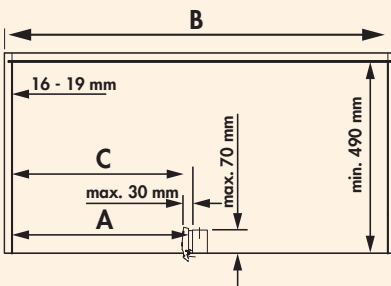
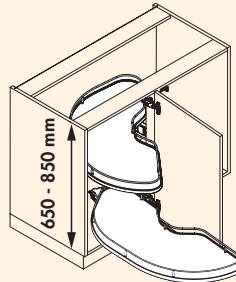
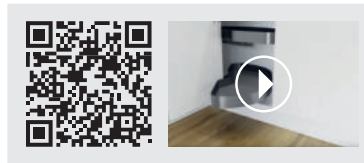

A	B (min.)	C
450	900	min. 411
500	1000	min. 461
600	1000	min. 561

Cornerstone Maxx fitting set

Corner cupboard swivel fitting for accommodating shelves.

- for 900 mm cabinet width and 450 mm door width
- for 1000 mm cabinet width and 500 or 600 mm door width
- installation height 650–850 mm
- installation depth min. 490 mm
- telescopic
- swivels out to the right or left
- swivel technology that slides straight out, no obstruction of the adjacent cabinet

Set consisting of:

- standpipe
- 2 x swivel arm
- pipe fixture above

Please note:

Shelves need to be ordered separately!

8037098	silver	€ 455.95
8037130	anthracite	€ 455.95

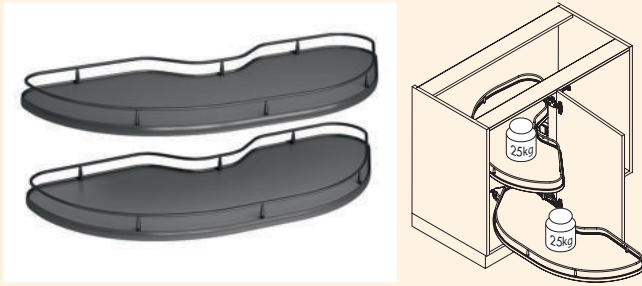

Cornerstone Maxx shelf set

Storage elements for corner cupboard swivel fitting Cornerstone Maxx.

- right and left variants
- for 900 mm cabinet width and 450 mm door width
- for 1000 mm cabinet width and 500 or 600 mm door width
- installation depth min. 490 mm
- door opening angle 85° so that shelves can slide out fully
- shelf variant 2/4
- load capacity max. 25 kg per shelf
- simple height adjustment of the shelves
- shelves that slide straight out: no obstruction of the adjacent cabinet
- shelves can be swivelled in and out independently of each other
- rail silver, shelf grey, thickness 16 mm
- rail anthracite, shelf anthracite, thickness 16 mm
- **door end stop right = left shelf**
- **door end stop left = right shelf**

Set consisting of:

- 2 x 2/4 shelf

Please note:

Cornerstone Maxx corner cupboard swivel fitting needs to be ordered separately!

8037101	900 mm cabinet, 450 mm door, shelf right, silver	€ 215.82
8037131	900 mm cabinet, 450 mm door, shelf right, anthracite	€ 215.82
8037100	900 mm cabinet, 450 mm door, shelf left, silver	€ 215.82
8037132	900 mm cabinet, 450 mm door, shelf left, anthracite	€ 215.82
8037103	1000 mm cabinet, 500 mm door, shelf right, silver	€ 229.86
8037133	1000 mm cabinet, 500 mm door, shelf right, anthracite	€ 229.86
8037102	1000 mm cabinet, 500 mm door, shelf left, silver	€ 229.86
8037134	1000 mm cabinet, 500 mm door, shelf left, anthracite	€ 229.86
8037105	1000 mm cabinet, 600 mm door, shelf right, silver	€ 239.26
8037135	1000 mm cabinet, 600 mm door, shelf right, anthracite	€ 239.26
8037104	1000 mm cabinet, 600 mm door, shelf left, silver	€ 239.26
8037170	1000 mm cabinet, 600 mm door, shelf left, anthracite	€ 239.26

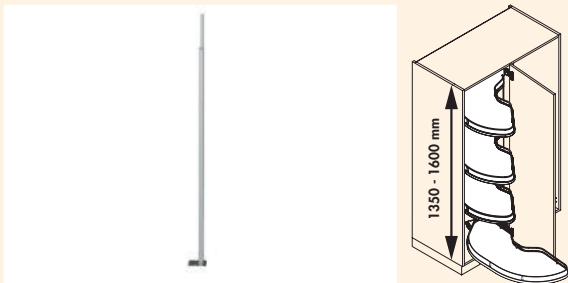

Cornerstone Maxx standpipe

System component for height extension for corner cupboard swivel fitting Cornerstone Maxx.

- for attaching up to four swivel arms
- for 900 mm cabinet width and 450 mm door width
- for 1000 mm cabinet width and 500 or 600 mm door width
- installation height 1350–1600 mm, installation depth min. 490 mm

Please note:

Corner cupboard swivel fitting and shelves need to be ordered separately!

8037099	zinc	€ 58.90
---------	------	---------

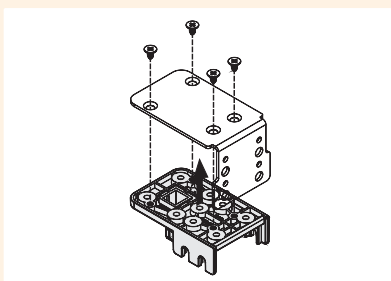

Cornerstone Maxx blind attachment

System component for attachment of the corner cupboard swivel fittings using a blind front instead of a central post.

8037128	silver	€ 23.08
---------	--------	---------



VS COR Fold

The VS COR Fold makes optimum use of the storage space in the corner cupboard. When opened, the front baskets swivel out freely and enable access to the rear baskets, which automatically move forward into the front part of the cupboard. The integrated damping with self-closing ensures silent closing.

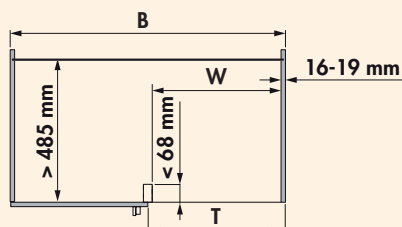
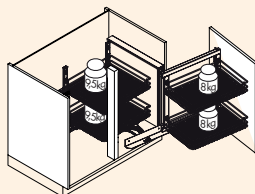

	K800	K900
B	min. 800	min. 900
T	min. 400	min. 450
W	≥361	≥411

VS COR Fold frame

Corner cupboard swivel fitting for 800 mm and 900 mm cabinet widths.

- for 800 mm cabinet width and 400 mm door width
- for 900 mm cabinet width and 450 mm door width
- installation depth min. 485 mm
- installation height min. 530 mm
- swivels out to the right or left
- full pull-out with damping
- tool-free mounting of the front on the drawer
- 3D front adjustment
- load capacity of the system: max. 35 kg
- **frame right = swivels out to the right**
- **frame left = swivels out to the left**

Please note:

Baskets need to be ordered separately!

8037073	800 mm cabinet, 400 mm door, right, silver	€ 425.05
8037074	800 mm cabinet, 400 mm door, left, silver	€ 425.05
8037136	800 mm cabinet, 400 mm door, right, anthracite	€ 425.05
8037137	800 mm cabinet, 400 mm door, left, anthracite	€ 425.05

8037075	900 mm cabinet, 450 mm door, right, silver	€ 433.49
8037076	900 mm cabinet, 450 mm door, left, silver	€ 433.49
8037138	900 mm cabinet, 450 mm door, right, anthracite	€ 433.49
8037139	900 mm cabinet, 450 mm door, left, anthracite	€ 433.49



VS COR Fold Premea basket set

- Storage elements for VS COR Fold frame.
- for 800 mm and 900 mm cabinet widths
 - dimensions front baskets 84 x 450 x 230/305 mm (H x W x D)
 - dimensions back baskets 84 x 330/430 x 370 mm (H x W x D)
 - load capacity front baskets max. 8 kg per basket
 - load capacity back baskets max. 9.5 kg per basket
 - rail silver, shelf grey, thickness 8 mm
 - rail anthracite, shelf anthracite, thickness 8 mm

Set consisting of:

- 2 front baskets
- 2 back baskets

8037077	800 mm cabinet, silver	€ 337.73
8037140	800 mm cabinet, anthracite	€ 337.73
8037078	900 mm cabinet, silver	€ 355.63
8037141	900 mm cabinet, anthracite	€ 355.63



VS COR Wheel Pro

The corner cupboard solution VS COR Wheel Pro is characterised by its unique design. The otherwise standard, space-consuming standpipe is now superfluous. This creates up to 20 percent more storage space in the centre of the shelf.

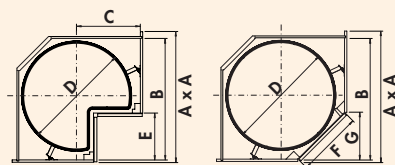

A x A mm	B mm	C mm	D mm	E mm	F mm	G mm
900 x 900	> 835	440	760	< 335	< 455	< 321

VS COR Wheel Pro

Corner cupboard swivel fitting for optimum space utilisation.

- for 900 x 900 mm cabinet widths
- installation height 620 mm
- body side depth min. 490 mm
- shelf variants 3/4 or 4/4
- load capacity max. 27.5 kg per shelf
- invisible mechanics
- individual height adjustment of the shelves
- tool-free installation of the shelves on the support arms
- rail silver, shelf grey, thickness 16 mm
- rail anthracite, shelf anthracite, thickness 16 mm

8037114 900 x 900 mm cabinet, 3/4, 2 pc., silver € 515.99

8037142 900 x 900 mm cabinet, 3/4, 2 pc., anthracite € 515.99

8037122 900 x 900 mm cabinet, 4/4, 2 pc., silver € 496.32

8037143 900 x 900 mm cabinet, 4/4, 2 pc., anthracite € 496.32

Cabinet equipment



VS SUB Slim

The VS SUB Slim tiered pull-out makes optimum use of the niches in the kitchen. As a shelf, towel holder or baking tray holder, it makes use of even the smallest gaps.

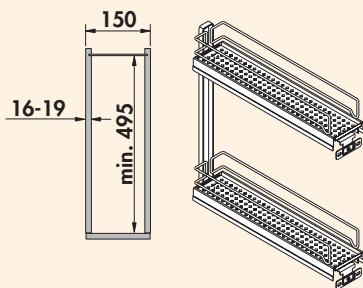

VS SUB Slim shelf

Tiered pull-out incl. two storage elements and complete pull-out runner.

- cabinet width 150 mm
- installation depth min. 495 mm
- installation height min. 530 mm
- end stop only right
- 2 storage elements
- load capacity max. 6 kg per storage element
- integrated damping and self-closing in both runners
- rail silver or anthracite
- 3D front adjustment

8037001 silver	€ 155.79
8037144 anthracite	€ 155.79

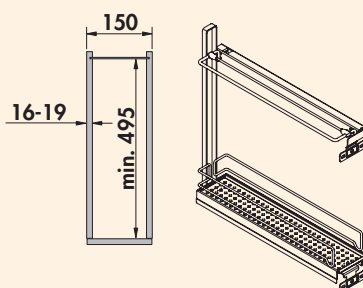

VS SUB Slim baking tray holder

Tiered pull-out with baking tray holder and storage element, incl. complete pull-out runner.

- cabinet width 150 mm
- installation depth min. 495 mm
- installation height min. 530 mm
- end stop only right
- 1 baking tray holder and 1 storage element
- load capacity max. 6 kg per storage element
- integrated damping and self-closing in both runners
- rail silver or anthracite
- 3D front adjustment

8037002 silver	€ 172.63
8037145 anthracite	€ 172.63

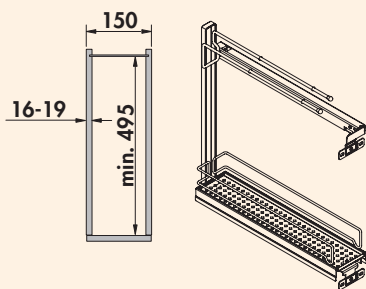

VS SUB Slim towel holder

Tiered pull-out with towel holder and storage element, incl. complete pull-out runner.

- cabinet width 150 mm
- installation depth min. 495 mm
- installation height min. 530 mm
- end stop only right
- 2-fold towel holder and 1 storage element
- load capacity max. 6 kg per storage element
- integrated damping and self-closing in both runners
- rail silver or chrome
- 3D front adjustment

8037003 silver	€ 166.05
8037146 anthracite	€ 166.05

Cabinet equipment



VS SUB Side

The VS SUB Side pull-out allows you to make maximum use of the storage space in a 300 mm wide cabinet.

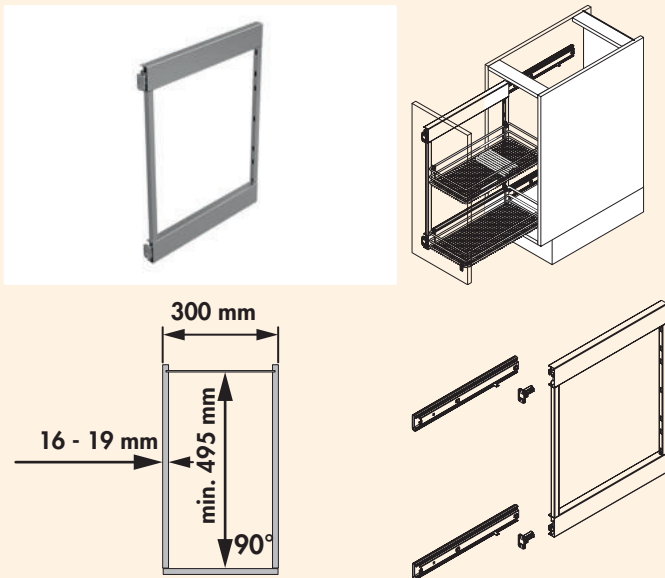

VS SUB Side frame

Pull-out drawer incl. runners.

- cabinet width 300 mm
- installation depth min. 495 mm
- installation height min. 619 mm
- end stop left or right
- 2 runners
- integrated damping and self-closing in both runners
- load capacity of the system max. 20 kg
- individual height adjustment of the baskets
- 3D front adjustment
- tool-free mounting of the front on the drawer

Please note:

Baskets need to be ordered separately!

8037007	H 619 mm, for 2 baskets, silver	€ 155.79
8037147	H 619 mm, for 2 baskets, anthracite	€ 155.79



VS SUB/TAL Side Premea basket set

Storage elements for VS SUB/TAL Side frame.

- basket dimensions 84 x 220 x 470 mm (H x W x D)
- suitable for cabinet width 300 mm
- set consisting of two baskets
- rail silver, shelf grey, thickness 8 mm
- rail anthracite, shelf anthracite, thickness 8 mm

8037010	silver	€ 123.84
8037148	anthracite	€ 123.84



Internal pull-out Classic

Pull-out basket. With integrated damping and self-closing (Grass Nova pro runner).

Suitable for wall thickness 16/18/19 mm.

- installation depth min. 500 mm
- installation height 120 mm incl. runner
- spacer strip for mounting behind the door
- load-bearing capacity max. 20 kg

8031180	450 mm cabinet, chrome-plated	€ 142.62
----------------	-------------------------------	-----------------

8031183	450 mm cabinet, anthracite	€ 137.00
----------------	----------------------------	-----------------

8031181	500 mm cabinet, chrome-plated	€ 147.28
----------------	-------------------------------	-----------------

8031184	500 mm cabinet, anthracite	€ 142.62
----------------	----------------------------	-----------------

8031182	600 mm cabinet, chrome-plated	€ 152.90
----------------	-------------------------------	-----------------

8031185	600 mm cabinet, anthracite	€ 147.28
----------------	----------------------------	-----------------



SpaceFlexx set

The flexible organising system SpaceFlexx solves the chaos of disorderly storage jars in drawers. It convinces with its optimal use of storage space and perfect adaptation to the contents and drawer.

The flexible division nesttex®, straps made of a special high-tech textile, adapts perfectly to the geometry of the jars. The belt straps are machine washable, German engineering und made in Germany.



SpaceFlexx set

Organising system. Suitable for all drawers from a width of 600 mm.

Set consisting of:

- 1 frame
- 5 flexible divisions nesttex®
- dimensions 130 x 472/520 x 472 mm (H x W x D)
- width adjustment with 472 or 520 mm, for optimum adjustment to the drawer

8031078	anthracite	€ 142.89
----------------	------------	-----------------



600
MINIMUM
CABINET



TopFlex pull-out table

Hidden invisibly and compactly behind a drawer front plate, the pull-out table is activated only when needed.



TopFlex pull-out table fitting

Freely suspended and without table top.

- with lowerable front
- extendable up to 810 mm
- independent of width from 450–900 mm
- body depth min. 500 mm
- load bearing capacity max. 30 kg

1111033 silver

€ 278.23



TopFlex pull-out table

Preassembled with white melamine resin coated table top.

- with lowerable front
- 16 x 546 x 422 mm (H x W x D)
- load bearing capacity max. 30 kg

Not suitable for kitchens without handles.

1111034 for 600 mm cabinet, white

€ 366.61



ChefsTable

The ChefsTable takes kitchen organisation to a whole new level. Equipped with a clever parallel swivel mechanism, this table swivel fitting makes it possible to gently and safely swing out heavy equipment. Whether for the Thermomix or other kitchen appliances. The swivel fitting is designed for all kitchen utensils up to a load capacity of 16 kg. Infinitely adjustable for cabinet widths from 400 to 600 mm.

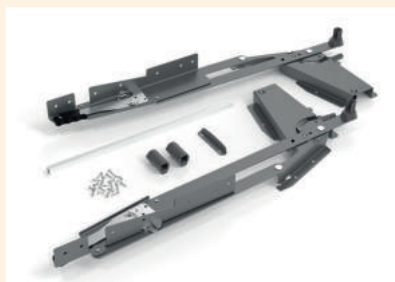

ChefsTable swivel fitting

Swivel fitting.

- infinitely adjustable from 400 to 600 mm cabinet width
- bearing capacity 16 kg
- integrated self-closing mechanism
- **mounting behind the hinged doors**

8031250 anthracite

€ 318.49



Cox® Wash laundry container pull-outs

Cox® Wash is the clean solution for dirty washing. Because with our laundry system, dirty washing can be neatly sorted, stored and transported. Completely invisibly. The hidden chute fits perfectly into any housekeeping area. Technically and visually, the Cox® Wash is based on our tried-and-tested waste separation systems from the Cox-Clan® range. This gives recycling and laundry a uniform look. The new laundry containers in a unique variety of models have rounded openings for optimum air circulation and thus help to protect the laundry.

- soft retraction and damping
- "quick & easy" mounting frame for different body thicknesses (16/19 mm)
- "nova Pro" guide rail 510 mm deep
- available for 45, 50 and 60 cm base units
- handles light grey
- installation depth 516 mm
- installation height 580 mm

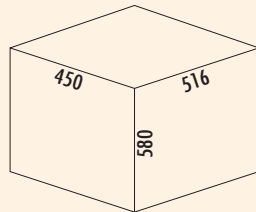

Cox® Wash laundry container pull-out 580/450-2

Laundry container pull-out.

- frame white/guide silver
- technology: over extension
- mounting: cabinet side panel and front panel
- container volume 70 (2 x 35) litres
- **with soft retraction and damping**
- installation depth 516 mm



8031194 white

€ 432.69

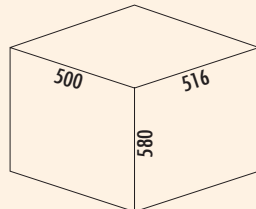

Cox® Wash laundry container pull-out 580/500-2

Laundry container pull-out.

- frame white/guide silver
- technology: over extension
- mounting: cabinet side panel and front panel
- container volume 70 (2 x 35) litres
- **with soft retraction and damping**
- installation depth 516 mm



8031195 white

€ 432.69

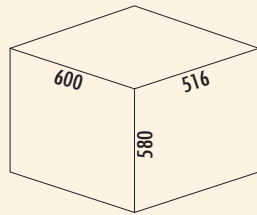

Cox® Wash laundry container pull-out 580/600-2

- Laundry container pull-out.
- frame white/guide silver
 - technology: over extension
 - mounting: cabinet side panel and front panel
 - container volume 88 (2 x 44) litres
 - **with soft retraction and damping**
 - installation depth 516 mm

8031196 white

€ 487.12

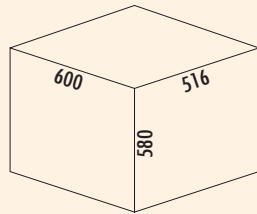

Cox® Wash laundry container pull-out 580/600-3

- Laundry container pull-out.
- frame white/guide silver
 - technology: over extension
 - mounting: cabinet side panel and front panel
 - container volume 91 (2 x 35/1 x 21) litres
 - **with soft retraction and damping**
 - installation depth 516 mm

8031197 white

€ 487.12

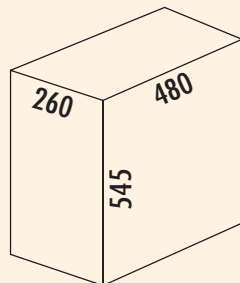

Traditionline Laundry 545 S/300-1

- Laundry pull-out.
- guide silver
 - technology full pull-out
 - installation cupboard bottom
 - container volumes 42 (1 x 42) liters
 - installation depth 480 mm

When installing in 30-gauge cupboard pay attention to the hinge position.

8031176 white

€ 169.74



Pullboy Soft Comfort® Laundry laundry container pull-outs

The Pullboy Soft Comfort Laundry is the clean solution for dirty washing. Because with our laundry system, dirty washing can be neatly sorted, stored and transported. Completely invisibly. The concealed chute fits perfectly into any housekeeping area. The new laundry containers in a unique variety of versions are equipped with rounded openings to ensure optimal air circulation and thus protect the laundry.

- pull-out lock with self-closing mechanism and damper
- body thicknesses (16/19 mm)
- available for 60 cm base cabinets

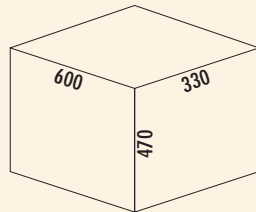

Pullboy Soft Comfort® Laundry 470 K/600-2

Laundry container pull-out.

- frame white/guide silver
- full pull-out technology
- mounting cabinet side and front panel
- container volume 52 (2 x 26) litres
- with soft retraction and damping
- installation depth 330 mm



8011728 white

€ 307.06

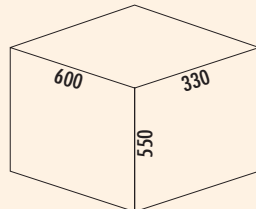

Pullboy Soft Comfort® Laundry 550 K/600-2

Laundry container pull-out.

- frame white/guide silver
- full pull-out technology
- mounting cabinet side and front panel
- container volume 64 (2 x 32) litres
- with soft retraction and damping
- installation depth 330 mm



8011729 white

€ 313.03

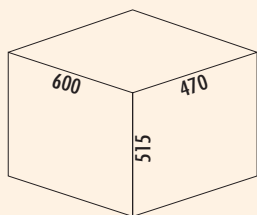

Pullboy Soft Comfort® Laundry 515 S/600-2

- Laundry container pull-out.
- frame white/guide silver
 - full pull-out technology
 - mounting cabinet side and front panel
 - container volume 84 (2 x 42) litres
 - with soft retraction and damping
 - installation depth 470 mm

8011726 white

€ 330.09

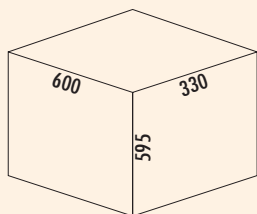

Pullboy Soft Comfort® Laundry 595 K/600-1

- Laundry pull-out.
- white frame/silver runner
 - full-extension runner technology
 - assembly of wall unit and front panel
 - bin capacity 50 (1 x 50) litres
 - with soft-close mechanism and damping
 - installation depth 330 mm

8011727 white

€ 279.76

Cabinet equipment

STOREX®

Holders and hooks

Most welcome



■ Cleaning Agent	Page 550
Vario organising system	Page 550
Cleaning agent pull-outs	Page 551
Spacer strip	Page 551
Towel holder	Page 551–552
Ventilation grids	Page 553
Hook strip	Page 553
Cleaning agent basket	Page 553



Cleaning Agent

Absolutely practical, very solid and extremely compact in design. In the smallest of spaces, Cleaning Agent offers many practical details and plenty of space to carry everything you need for cleaning. Sponges, brushes and other tools are always at hand on the top tray.

It can be pulled out with one finger – thanks to the Softstopp it closes gently and quietly.

Especially handy: the cleaning agent basket with ergonomic handle. All plastic bowls can be removed and cleaned in the dishwasher – so that the Cleaning Agent is always clean.



Cleaning Agent

Cleaning agent pull-out. With ergonomic carrying handle.

Consisting of:

- 1 system support
- 1 insertable basket with carrying handle
- 2 large and 1 small container
- 6 separating hoops
- 480 x 298 x 480 mm (H x W x D)

8031103 grey

€ 155.09



Vario organising system

The consistent elliptic design of the anodised aluminium profiles in connection with the square, perforated base plate and the high-quality, stable plastic elements gives the organising system Vario its exclusive character.

Vario may be installed on the right or left in the floor cabinet.



Vario organizing system 3909

Pull-out for installation on the side wall, 3-part, with one large and two narrow trays.

- 481 x 158 x 483 mm (H x W x D)

8035010 aluminium

€ 243.03



Cleaning agent pull-out model 3

Pull-out basket. For clear placing of cleaning and dishwashing agents.
– 400 x 117 (140 mm incl. guide) x 470 mm (H x W x D)

For each pull-out, 2 spacer strips are required for bridging the door hinges.
Order separately if needed.

8031042 chrome € 146.66



Spacer strip

Plastic, for ball guide, to bridge the door hinges.
2 spacer strips are needed per pull-out.

8031041 width 25 mm € 14.57



Towel holder Secco AluLine

Two or three armed version available.
Universal installation, installation from a width of 150 mm, extendable.
– length 457 mm

8032015 2-armed, W 122 mm, aluminium/graphite-grey € 53.01

8032016 3-armed, W 184 mm, aluminium/graphite-grey € 60.04



Towel holder Secco S

One-armed version.
Installation for all front pull-outs, adjustable to fit all cabinet situations. The towel disappears aesthetically and discretely into the pull-out cabinet when not in use.
– length 457 mm
– height 200 mm

8032017 1-armed, lightgrey € 31.16



Towel holder De Luxe S

Two or three armed version available. Universal installation on the side wall or underneath, 495 mm long, extendable.

Cover not included in scope of delivery, please order separately.

8031048 2-armed, W 102 mm, chrome € 66.88

8031049 3-armed, W 145 mm, chrome € 72.15

Optional accessories

8031009 Cover for towel holder, grey € 8.25



Towel holder De Luxe 1

Two or three armed version available. Aluminium version.
Universal installation on the side wall or underneath, L 465 mm, extendable.

8032005 2-armed, W 95 mm, silver € 54.33

8032008 3-armed, W 143 mm, silver € 68.90



Towel holder De Luxe 2

Two or three armed version available. Universal installation on the side wall or underneath, L 410 mm, extendable.

Cover not included in scope of delivery, please order separately.

8032014	2-armed, anthracite	€ 73.19
8032018	3-armed, anthracite	€ 76.98

Optional accessories

8032019	Cover for De Luxe 2 towel rail, anthracite	€ 8.69
----------------	--	--------



Towel holder for bathrooms with cover

One or two armed version available. For installation on the side, 325 mm long, extendable.

8031089	1-armed, W 65 mm, chrome	€ 63.10
8031090	2-armed, W 105 mm, chrome	€ 73.19



Cabinet equipment

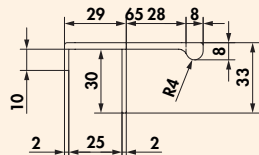

Towel holder for handle-less kitchens, Towel holder

- aluminium anodised
- for handle-less kitchens, with front thickness of 16–21 mm
- no installation work, simply push-on
- felt insert supplied loose, glue in prior to fitting

8032009	L 320 mm, stainless steel coloured	€ 43.27
8032010	L 520 mm, stainless steel coloured	€ 72.49
8032013	L 520 mm, black matt	€ 72.49
8032023	L 320 mm, black matt	€ 43.27



Towel holder for handle bars



– no installation work, simply attach to the existing handle strip

8032100	L 270 mm, polished stainless steel	€ 52.10
8032101	L 270 mm, aluminium anodised, black matt	€ 49.58
8032102	L 470 mm, polished stainless steel	€ 85.29
8032108	L 470 mm, aluminium anodised, black matt	€ 82.35



Ventilation grid 1

Metal ventilation grid. Ventilation shaft 313 cm²/m.

- (1) W 250 mm, D 70 mm, cut-out dimension W 225 mm x D 58 mm
- (2) W 500 mm, D 70 mm, cut-out dimension W 475 mm x D 58 mm
- (3) W 750 mm, D 70 mm, cut-out dimension W 725 mm x D 58 mm
- (4) W 900 mm, D 70 mm, cut-out dimension W 875 mm x D 58 mm

8033050 (1) silver	€ 14.66
8033051 (1) stainless steel col.	€ 17.02
8033052 (1) black matt	€ 15.97
8033053 (2) silver	€ 23.35
8033054 (2) stainless steel col.	€ 32.30
8033055 (2) black matt	€ 30.37
8033056 (2) white	€ 33.17
8033057 (3) silver	€ 34.14
8033058 (3) stainless steel col.	€ 40.90
8033059 (3) black matt	€ 38.45
8033060 (4) silver	€ 38.27
8033061 (4) stainless steel col.	€ 45.90
8033062 (4) black matt	€ 45.90



Ventilation grid 2

Metal ventilation grid.

- 500 x 110 mm (W x D)
- cut-out dimension 475 x 98 mm (W x D)
- ventilation area ca. 496 cm²/m

8033005 silver	€ 25.81
8033027 black matt	€ 28.60
8033028 stainless steel col.	€ 30.71



Hook strip

For wall mounting. 5 hooks.

- 49 x 350 x 43 mm (H x W x D)

8031031 chrome	€ 12.02
-----------------------	---------



Cleaning agent basket 1

Closed on three sides, may be bolted. With hooks for cloths and dusters.

- 100 x 330 x 115 mm (H x W x D)

8031117 silver	€ 18.70
-----------------------	---------

Cabinet
equipment

STOREX®

Built-in appliances for drawers

Concealed and immediately
good to go



Multi-slicers	Page 556–558
Metal crossbar	Page 557
Evoline® Wing	Page 558
Built-in toaster	Page 559
Built-in hand blender	Page 559

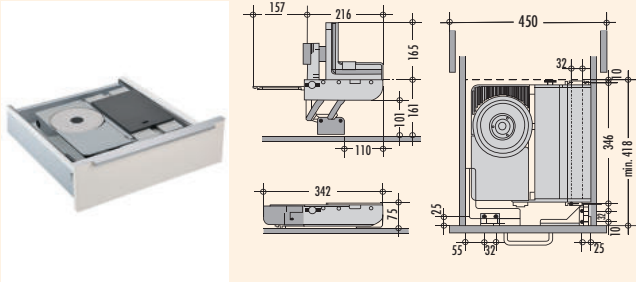
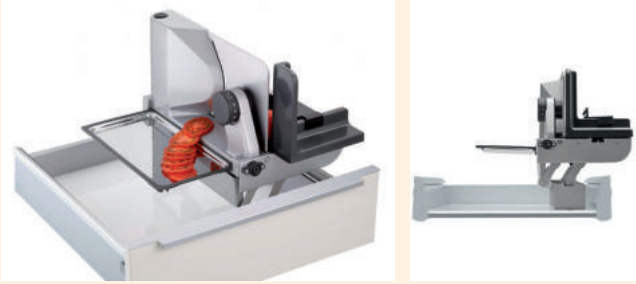

ritter multi-cutter AES 72 SR



For installation in drawers from 450 mm cabinet width. Prerequisite: clear internal dimension: >344 mm. Stands in front of the worktop.

Distance from drawer bottom to upper worktop edge min. 116 mm, max. 161 mm.

- high-quality all-metal design
- drive: high-performance energy-saving motor 230 V, 65 watt short-time, operation 5 minutes
- 2 finger safety switching system
- circular blade: electrolytically polished edge Ø 170 mm, serrated
- bayonet quick lock for tool-free blade removal
- cutting width adjustment: up to approx. 14 mm
- fold-in lock when slice thickness set
- stand fitting locks automatically
- cable length 80 cm
- 75 x 342 x 365 mm (H x W x D), weight 4.3 kg
- accessories: cuttings tray made of stainless steel, fixing bracket for finger protection and left-overs holder
- 5 years manufacturer's warranty (see www.ritterwerk.de/garantie)

1111044 silver metallic, cuttings guided on the right € 794.29

Optional accessories

1111067 Ham slicer, smooth € 101.81

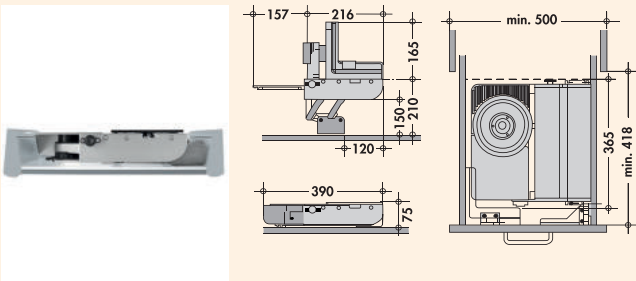
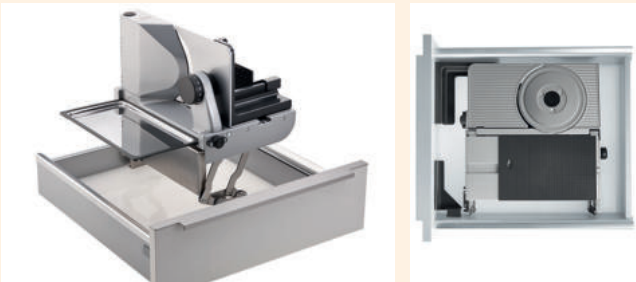

ritter multi-cutter AES 72 SR-H



High version for installation in drawers from 500 mm cabinet width. Prerequisite: clear internal dimension: >392 mm. Stands in front of the worktop.

Distance from drawer bottom to countertop top min. 165 mm, max. 210 mm.

Particularly suitable for handle-less kitchens or thicker work surfaces.

- high-quality all-metal design
- drive: high-performance energy-saving motor 230 V, 65 watt short-time, operation 5 minutes
- child safety lock with 2-finger activation system
- circular blade: polished edge, Ø 170 mm, serrated, the scissor lift and stand fitting locks automatically
- bayonet quick lock for tool-free blade removal
- cutting width adjustment: up to approx. 14 mm
- fold-in lock when slice thickness set
- set-up fitting locks automatically
- cable length 80 cm
- 75 x 390 x 365 mm (H x W x D), weight 4.3 kg
- accessories: cuttings tray made of stainless steel, fixing bracket for finger protection and left-overs holder
- 5 years manufacturer's warranty (see www.ritterwerk.de/garantie)

1111030 silver metallic, cuttings guided on the right € 882.95

Optional accessories

1111067 Ham slicer, smooth € 101.81

Cabinet equipment

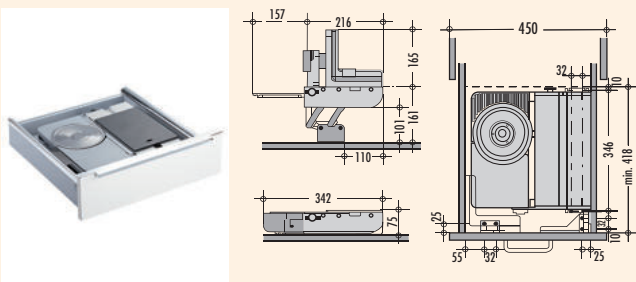

ritter multi-cutter model AES 62



For installation in drawers from 450 mm cabinet width. Prerequisite: clear internal dimension: >344 mm. Stands in front of the worktop. Distance from drawer bottom to upper worktop edge: min. 116 mm, max. 161 mm.

- drive: high-performance energy-saving motor 230 V, 65 watt, safety-brief and continuous operation switch, short-time operation 5 minutes
- metal design
- round blade: polished blade Ø 170 mm, with serrated edge
- cutting width adjustment: up to approx. 14 mm
- fold-in lock when slicethickness set
- stand fitting locks automatically
- cable length 80 cm
- 75 x 342 x 365 mm (H x W x D), weight: 4.1 kg
- accessories: cuttings tray made of stainless steel, fixing bracket for finger protection and left-overs holder
- 5 years manufacturer's warranty (see www.ritterwerk.de/garantie)

1111051 silver-metallic, cuttings guided on the left € 664.40

1111062 silver-metallic, cuttings guided on the right € 664.40

Optional accessories

1111058 Ham and cold cuts knife, smooth € 85.83

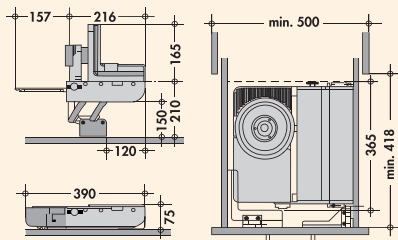
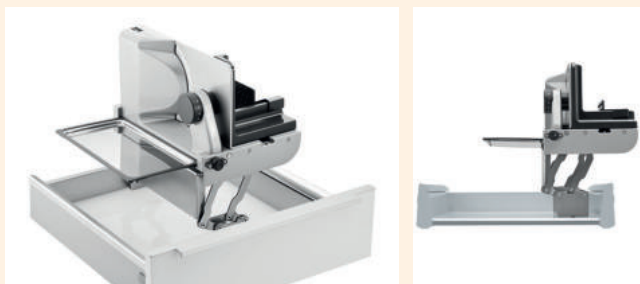

ritter multi-cutter AES 62-H



High version for installation in drawers from 500 mm cabinet width. Prerequisite: clear internal dimension: >392 mm. Stands in front of the worktop.

Distance from drawer bottom to countertop top min. 165 mm, max. 210 mm. Particularly suitable for handle-less kitchens or thicker work surfaces.

- drive: high-performance energy-saving motor 230 V, 65 watt short-time, operation 5 minutes
- metal design
- circular blade: polished edge, Ø 170 mm, serrated, the scissor lift and stand fitting locks automatically
- cutting width adjustment: up to approx. 14 mm, fold-in lock when slice thickness set
- cable length 80 cm
- 75 x 390 x 365 mm (H x W x D), weight 4.1 kg
- accessories: cuttings tray made of stainless steel, fixing bracket for finger protection and left-overs holder
- 5 years manufacturer's warranty (see www.ritterwerk.de/garantie)

1111031	silver metallic, cuttings guided on the left	€ 756.56
1111032	silver metallic, cuttings guided on the right	€ 756.56

Optional accessories

1111058	Ham and cold cuts knife, smooth	€ 85.83
----------------	---------------------------------	----------------

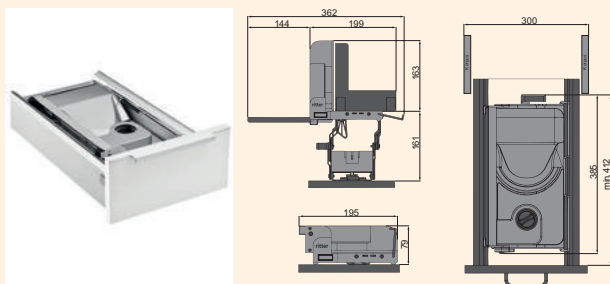
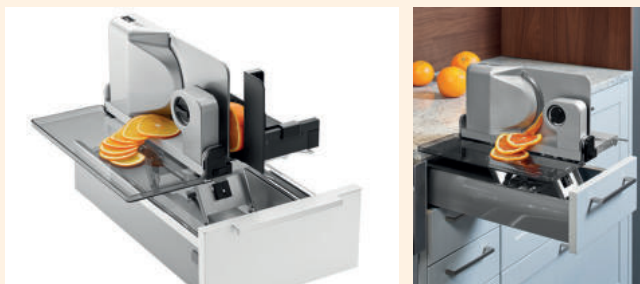

ritter multi-cutter model AES 52



For installation in drawers from 300 mm cabinet width. Prerequisite: clear internal dimension >197 mm. Stands in front of the worktop.

- drive: high-performance energy-saving motor 230 V, 65 watt, safety, brief and continuous operation switch, short-time operation 5 minutes.
- metal design
- round blade: polished blade, Ø 170 mm, with serrated edge
- cutting thickness setting: up to approx. 14 mm
- fold-in lock when slice thickness set
- stand fitting locks automatically
- device can be removed from the draw without tools for cleaning
- cable length 80 cm
- 79 x 195 x 385 mm (H x W x D), poids 4.3 kg
- accessories: cuttings tray, plastic
- 5 years manufacturer's warranty (see www.ritterwerk.de/garantie)

1111043	silver-metallic, cuttings guided on the right	€ 759.19
----------------	---	-----------------

Optional accessories

1111058	Ham and cold cuts knife, smooth	€ 85.83
----------------	---------------------------------	----------------

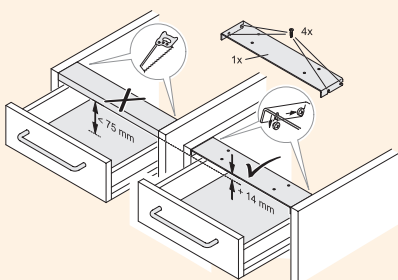

Metal crossbar

Suitable for all built-in multi-cutters and built-in toasters. The metal crossbars are needed if the clearance height is not sufficient for mounting, e.g. for under-floor guides or, to some extent, in case of handleless kitchens. If the standard crossbars are replaced by the thin metal crossbars, as a rule, 14 mm clearance height is gained.

Only suitable for cabinets with 16 mm wall thickness.

1111046	for 300 mm cabinet	€ 46.70
1111057	for 400 mm cabinet	€ 49.95
1111068	for 450 mm cabinet	€ 51.87
1111069	for 500 mm cabinet	€ 56.09
1111070	for 600 mm cabinet	€ 60.04
1111071	for 800 mm cabinet	€ 90.40
1111077	for 900 mm cabinet	€ 92.16
1111078	for 1000 mm cabinet	€ 100.93
1111084	for 1200 mm cabinet	€ 115.85



Evoline® Wing

The electrical connection right in the drawer: movable and extendable furniture parts can be equipped with the Evoline® Wing cable management system. Available in the variants single socket plus charger and double socket without charger. The cable duct without socket is also available, as well as the socket element without cable duct.

The system offers individual mounting options, the cable ducting is carried out in a space-saving manner, for example behind the drawer. Cables are neither twisted nor pinched.

Product variants with cable ducting contain fastening elements for furniture parts made of wood and metal. Evoline® Wing is suitable for all types of cables such as HDMI, LAN etc., even wire cords for securing drawer pull-outs can be safely accommodated in the cable duct arm.

Suitable for drawers from 400 mm wide and up to an pull-out length of 590 mm.

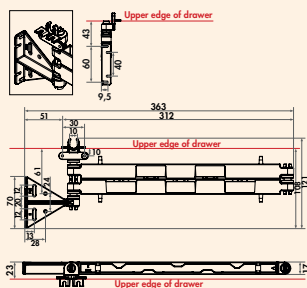

Evoline® Wing



Cable routing. Mounting elements for wooden and metal furniture items are included in the scope of delivery.

- L 363 mm (closed)
- D 17 mm (closed)
- **Suitable for drawers from 400 mm wide and up to an pull-out length of 590 mm.**

8031191 without earthed plug sockets, black matt

€ 66.88



ritter multi-slicer E118



For installation on swivel systems in floor cabinets from 400 mm width.

- drive: high-performance energy-saving motor 230 V, 65 watt, safety, brief and continuous operation switch, short-time operation 5 minutes
- metal design
- round blade: polished blade, Ø 170 mm, with serrated edge
- cutting thickness setting: up to approx. 14 mm
- cable length 73 cm
- 210 x 205 x 330 mm (H x W x D), weight 3 kg
- accessories: cuttings tray, mounting accessories
- 5 years manufacturer's warranty (see www.ritterwerk.de/garantie)

1111054 silver-metallic, cuttings guided on the left

€ 267.69

Optional accessories

1111058 Ham and cold cuts knife, smooth

€ 85.83

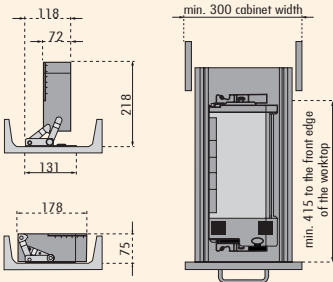
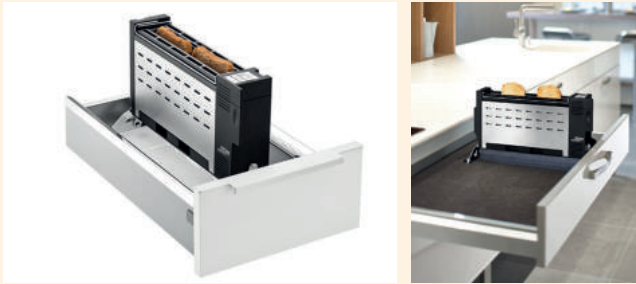

ritter built-in toaster ET 10



Built-in toaster for mounting in drawers **from 300 mm cabinet width**.

Prerequisite: clear internal dimension >180 mm.

- dimensions when retracted: 75 x 178 x 400 mm (H x W x D)
- stand mechanism in metal
- safety automatic switchoff, when toaster folded in
- toasting setting with LED display
- stop button
- defrost and reheat function
- bread centring
- integrated warming rack in stainless steel
- thermally insulated stainless steel housing
- crumb catching tray can be removed in standing and in lying position
- device can be removed from the draw without tools for cleaning
- cable length 105 cm
- 220–240 volts, 850–950 watts
- weight 2 kg
- 5 years manufacturer's warranty (see www.ritterwerk.de/garantie)

1111045 stainless steel/black

€ 447.62

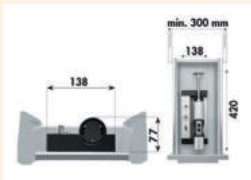

ritter built-in hand blender ESM 50



For installation in drawers from 300 mm cabinet width. Required: clear width >145 mm.

- cordless, battery operated hand blender
- charger securely mounted into cabinet drawer
- LED charge indicator

4 stainless steel attachments:

- utility knife: standard attachment for pureeing most foods
- whipping disk: for fluffy whipped foods
- stirring disc: for stirring thick creamy foods
- cutting knife: for cutting meat and fibrous fruit and vegetables
- 3 speeds: ca. 12,000 rpm, ca. 9,000 rpm, ca. 6,000 rpm
- aluminium housing, ergonomic plastic handle
- safety-2 finger-switch on system
- automatic safety shutdown in case of overload or overheating
- plug-in power supply 120 cm for charging station: input voltage 100–240 volts
- battery: 7.2 V, lithium-ion battery, 2.1 Ah
- 77 x 138 x 420 mm (H x W x D), weight 1.4 kilogram (including 400 g charging station)
- Ø 62 mm
- L 420 mm

1111090 aluminium/black

€ 697.75

Cabinet
equipment

STOREX[®]

Base built-in devices

Creative solutions
to special challenges



Base heating

All you can see

is a cover plate in the base

Page 562–566

STOREX®

Base heating KICKSPACE

Intelligent increase in planning freedom

**All you need is two hoses
and a mains connection.**

Kickspace is a heating module of the convector class, which can be quickly installed without any problems. Two flexible connecting hoses with 1/2" connectors and shut-off valve create a safe and durable connection to the central heating system.



However you chopped and changed in planning, the radiator was always in the way and consumed space which was needed for additional base units and uninterrupted work surfaces. Often, unsatisfactory compromises are then made: For example, the heaters are installed in floor cabinets, which causes heat problems and turns free space into unwanted storage area.

The solution is at hand: a heat source which adjusts to planning and not vice versa. Which requires only minimal space and is also visually appealing. And, most importantly, which provides heating performance equal to that of the radiator and can be integrated into the central heating system.



Kickspace was developed in response to precisely these considerations. Compact heating, not just for kitchens, but for all rooms. Planning-friendly in its dimensions, safe and powerful in its function. And you can really only spot Kickspace through the stainless steel coloured cover plate. The hot water that constantly flows through the appliance provides rapid, efficient and comfortable warmth.

With operation based on requirements and a substantially shorter time for heating up compared with a conventional radiator, there is potential for saving energy which more than compensates for the power needed for operation of the super-silent fan (on average less than 20 W).

The sturdy metal housing, which optimally protects the heating system, may be positioned in the base area with little effort. After fixing the cover plate and pressing the on/off switch, **Kickspace** offers powerful heating with a choice of two performance stages. Cooling air circulation in summer operation is a welcome additional benefit.

Kickspace may be controlled manually or automatically by connecting it to a room thermostat.

STOREX®

Base heating KICKSPACE

Everything you need in heat performance is under quick and almost noiseless control



Putting powerful convector technology in a minute space is a job for specialists. Kickspace was developed by one of the most experienced companies in the sector of convector technology, matured ready for marketing and successfully launched.

The functional principle of convector technology is illustrated by the figure. The air drawn in on the two sides of the cover plate is emitted to the room with

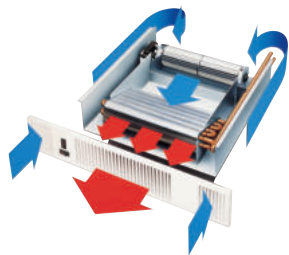

the assistance of different fan speeds through the central sector of the cover plate. Special bearing and attenuation technology of the fan as well as a constructional principle minimizing the flow

noise ensure almost noiseless operation of the appliance.

Performance, safety and quality of all manufacturing units are subject to strict internal and external testing and monitoring.

Kickspace needn't shirk a comparison of performance with a conventional radiator. On the contrary: the comparison shows that a **Kickspace KS**

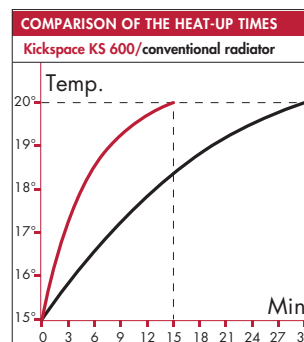

600 needs only about half the time to heat up a room of about 12 m² from a starting temperature of 15 °C to a comfortable temperature of 20 °C. Quick and effective heating up is one of **Kickspace's** strengths. The control of comfortable heat as needed

is another way of noticeably saving energy using **Kickspace**.

To heat up a room from a starting temperature of 15 °C to a comfortable temperature of 20 °C, a heating performance of about 70 W/m² is required under thermotechnical aspects. From this, roughly the performance data of the **Kickspace** models shown here may be derived, assuming a common feed/return flow water temperature of 70°/55° in the central heating circuit. Operation on stage I is wholly sufficient for normal operation. Stage II provides about 30 % more heating performance, which of course enables a noticeably shorter heating-up time where needed.

Performance figures

	Heating perform./ watt		... gives comfy warmth for rooms up to
	Stage I	Stage II	
Kickspace KS 500	740	976	about 12 m ²
Kickspace KS 600	981	1256	about 16 m ²

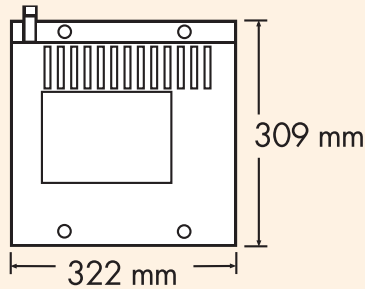

Kickspace KS 500

The compact base-installed heating system for rooms up to about 12 m² can be connected to the central heating system with little effort.

- connected load 230 V/50 Hz
- heating system exclusively for 2-pipe system
- minimum base height 125 mm

Cover plates need to be ordered separately.

PLEASE OBSERVE:

For proper operation, the average feed temperature should not fall below 60 °C.

The heat output of the device depends on the feed temperature and the flow rate of the heating system.

6011001 W 322 mm	€ 688.97
-------------------------	-----------------

Optional accessories

6011011 Room thermostat 230 V, white	€ 84.35
6011010 Reinforced hose, L 700 mm	€ 33.26
6011015 Reinforced hose, L 1000 mm	€ 33.44
6011016 Reinforced hose, L 1500 mm	€ 34.32
6011017 Kickspace-cover, KS 500, W 496 mm, stainless steel coloured	€ 210.64

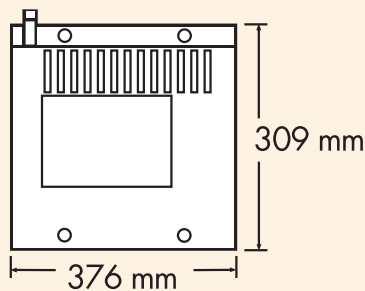

Kickspace KS 600

The compact base-installed heating system for rooms up to about 16 m² can be connected to the central heating system with much effort.

- connected load 230 V/50 Hz
- heating system exclusively for 2-pipe system
- minimum base height 125 mm

Cover plates need to be ordered separately.

PLEASE OBSERVE:

For proper operation, the average feed temperature should not fall below 60 °C.

The heat output of the device depends on the feed temperature and the flow rate of the heating system.

6011002 W 376 mm	€ 782.89
-------------------------	-----------------

Optional accessories

6011011 Room thermostat 230 V, white	€ 84.35
6011010 Reinforced hose, L 700 mm	€ 33.26
6011015 Reinforced hose, L 1000 mm	€ 33.44
6011016 Reinforced hose, L 1500 mm	€ 34.32
6011018 Kickspace-cover, KS 600, W 550 mm, stainless steel coloured	€ 210.64

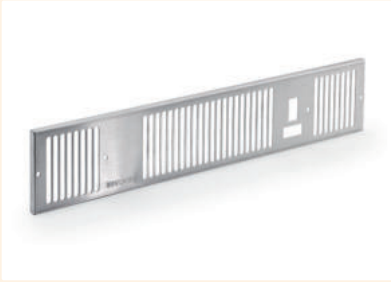

Kickspace-cover

You can only see the cover plate of Kickspace. The heating module and connections are invisibly placed in the otherwise unused base space. The cover plate matches any type of kitchen and ensures a visual highlight.
– H 101 mm

6011017	KS 500, W 496 mm, stainless steel coloured	€ 210.64
6011018	KS 600, W 550 mm, stainless steel coloured	€ 210.64

Optional accessories

6011002	Kickspace KS 600, W 376 mm	€ 782.89
6011001	Kickspace KS 500, W 322 mm	€ 688.97



Reinforced hose

For Kickspace. With 1/2" external thread and union nut.

Supply and return connection are planned.

6011010	L 700 mm	€ 33.26
6011015	L 1000 mm	€ 33.44
6011016	L 1500 mm	€ 34.32

Optional accessories

6011002	Kickspace KS 600, W 376 mm	€ 782.89
6011001	Kickspace KS 500, W 322 mm	€ 688.97



Room thermostat 230 V

For Kickspace.

The thermostat should be connected by an electrician to the supply line of the switchable mains outlet to which the Kickspace device is connected by an earthed plug.

6011011	white	€ 84.35
----------------	-------	---------

Optional accessories

6011002	Kickspace KS 600, W 376 mm	€ 782.89
6011001	Kickspace KS 500, W 322 mm	€ 688.97

Cabinet
equipment

STOREX®

Equipment for wall mounted cabinets

Everything in its place



Storage systems

Stable and elegant storage Page 569–572

Lift fittings

Clever use of storage space Page 573–578

STOREX®

Storage systems

Stable and elegant storage



■ Drawer container	Page 570
Tray for hood cabinet	Page 571
Boundary rail for wall mounted cabinets	Page 571
Broom cupboard shelf	Page 571
Hose holder	Page 571



Drawer container box

Made of solid beech wood for drawer containers made of ceramic.



Drawer container box 3

For three ceramic drawer containers. With covered wall mount.

- **drawer containers have to be ordered separately**
- 134 x 378 x 155 mm (H x W x D)
- can only be inserted horizontally

8022016 beech

€ 186.07



Drawer container box 4

For four ceramic drawer containers. With covered wall mount.

- **drawer containers have to be ordered separately**
- 134 x 500 x 155 mm (H x W x D)
- can only be inserted horizontally

8022017 beech

€ 205.38



Ceramic drawer container

- weight ca. 400 g
- capacity 0.75 l
- 106 x 116 x 145 mm (H x W x D)
- can only be inserted horizontally

8022005 smooth, white

€ 42.30



Tray for hood cabinet

The shelf for spice jars is perfectly tailored to the width and low depth of the extractor hood cabinet. Other utensils needed for cooking are also easily accommodated. The shelf is simply clipped onto the shelf supports. The supports included in the scope of delivery are suitable for 16- and 19-millimetre-thick side panels. Several shelves at freely selectable positions put the space in the cabinet to the best possible use.



Tray for hood cabinet

Complete with base supports, for 16 mm and 19 mm side walls.
– 40 x 560 x 70 mm (H x W x D)

8031027 silver

€ 14.66



Boundary rail for wall mounted cabinets

For 600 mm tall cabinets. With this rail, even smaller pots or bottles won't go overboard (rail for drilling).
– 35 x 504 mm (H x W)

8031060 chrome

€ 11.24



Broom cupboard shelf

Turns every common tall cabinet into a space wonder on four levels.
– 872 x 350 x 174 mm (H x W x D)

8031063 silver

€ 84.87



Hose holder

Suitable for storing various hoses.
– 100 x 198 x 55 mm (H x W x D)

8031066 silver

€ 10.71

Cabinet
equipment

STOREX®

Lift fittings

Clever use of storage space



■ FREEslide	Page 574
Appliance holder	Page 574
Gas pressure spring	Page 575
iMove	Page 576–577
TurnMotion	Page 577



Door lift fitting FREEslide

"Form follows function" – in a particularly aesthetic way. With FREEslide, the front moves straight up, which opens up a wide range of design options in kitchen planning.

FREEslide is also the perfect choice for cabinets hanging one above the other or wall cabinets with light or cornice profiles. All storage items are easily accessible and the integrated multi-position STOP guarantees an immediate and secure hold in any position. This means plenty of convenience behind a visually consistent cabinet front – not just in the kitchen, but throughout the entire house.

Adjust easily and safely:

The spring force is adjusted to different front weights for a feather-light run using a cordless screwdriver.

Minimal assembly effort:

The integrated positioning tabs ensure quick and perfect installation. With the subsequent screwing, you also save time and effort thanks to the pre-assembled Euro screws. The Euro screws grip directly on the base plate, which guarantees high stability of the movement system. As with the entire lifter family, the front connection is made using ClickFixx.

- front weight for 600-gauge width 3.4–6.7 kg
- suitable for cabinet heights 380–500 mm
- with opening support and closing damping



Door lift fitting FREEslide

Parallel lift fitting for hinge-free connection of front doors. Suitable for 16 mm and 19 mm side walls.

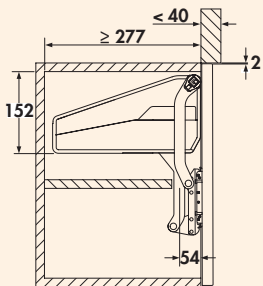

8031082 for 600 mm width

€ 234.34

Cabinet equipment

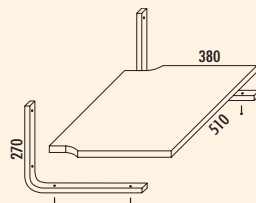

Appliance holder

Multi-functional use for microwave ovens, television sets, radios and other small appliances, max. load bearing capacity 30 kg. with white fixing plate, melamine resin coated, with 2 mm PVC front edge.

- 19 x 510 x 380 mm (H x W x D)

8031120 holder silver coloured

€ 148.24



Gas pressure spring

- with protecting cap grey
- for door lift fittings
- Ø 19 mm
- L 210 mm

8030101	200 N	€ 26.68
8030102	250 N	€ 26.68
8030103	380 N	€ 26.68



iMove

Lift fitting. In many kitchen designs, the desire for lots of storage space and a continuous cornice height leads to wall cupboard solutions where the upper levels are not within everyone's reach. As a result, either items or even supplies are stored here that are rarely, if ever needed - or the stepladder is a regularly used kitchen aid. Both variants are far from optimal.

High time for a pull-out system which makes the contents of a wall cupboard conveniently accessible: iMove. Can be operated with one hand. The entire top shelf level is conveyed down in front of the cabinet body in one elegant movement. In this way, the items stored can be reached even more conveniently than those on the lower level of the wall cupboard. This is further facilitated by the simultaneous lowering of the shelf rail.

At the end of the movement, removing the desired objects is child's play. A tremendous benefit, especially for the youngest members of the household.

The big height differences between the wall cupboards are equalled out by iMove through a high degree of built-in flexibility - and through the choice of models with one or two levels. The iMove Single covers cabinet heights from 520 mm (no upwards limit), the iMove Double is used in cabinet heights from 710 mm. Body differences, for example the thickness of the side walls, are easily compensated by the system. Suitable for hinged doors and lifting doors. Incl. an integrated softstop. This gently decelerates the iMove and also cushions it in the closing direction.

Advantages:

- no adjustment necessary
- load capacity up to 8 kg
- gentle lowering
- simple lifting
- mature technology
- best materials
- safe (finger protection)



Cabinet equipment

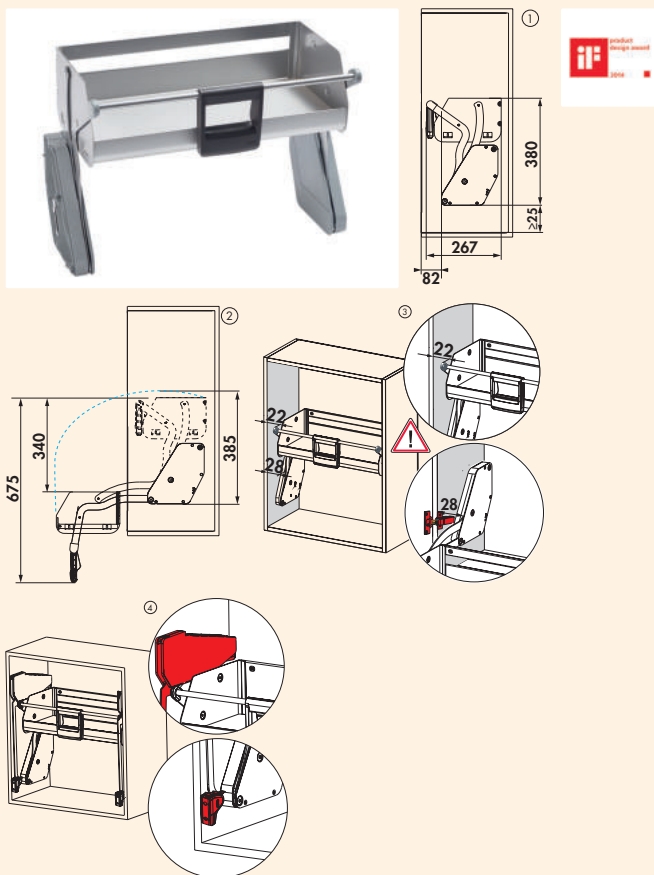

iMove set Single Tray

Lift fitting. Silver. Incl. fittings (1 drilling template, 8 wood screws 4.5 x 50 mm). Suitable for retrofitting.

- minimum cabinet height* (no upward limit)
- with hinged door: 520 mm
- with use of lift fittings: 650 mm
- suitable for 16 mm and 19 mm side walls
- load capacity up to 8 kg
- 380 x 267 mm (H x L)

*cabinet height depends on hinge position, hinge protrusion or lift fitting (see illustrations 1-4).

8031104	for 600 mm cabinet, W 562 mm	€ 370.37
8031105	for 900 mm cabinet, W 862 mm	€ 392.94

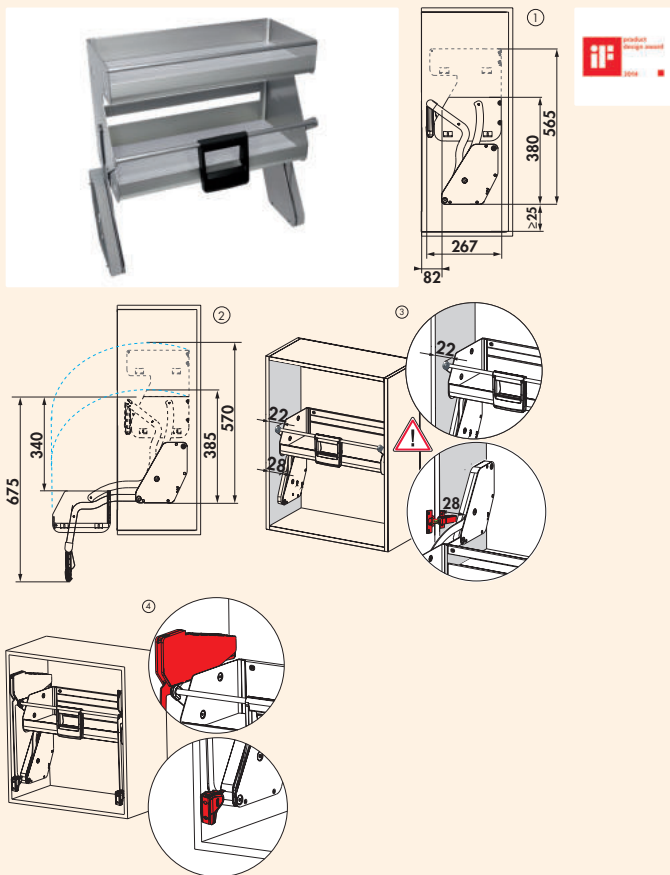

iMove set Double Tray

Lift fitting. Silver. Incl. fittings (1 drilling template, 8 wood screws 4.5 x 50 mm). Suitable for retrofitting.

- minimum cabinet height* (no upward limit)
- with hinged door: 710 mm
- with use of lift fittings: 710 mm
- suitable for 16 mm and 19 mm side walls
- load capacity up to 8 kg
- 565 x 267 mm (H x L)

*Cabinet height depends on hinge position, hinge protrusion or lift fitting (see illustrations 1–4).

8031106 for 600 mm cabinet, W 562 mm

€ 469.03



TurnMotion

The TurnMotion III swivel fitting is incredibly versatile – it is suitable for both base and tall cabinets. The 360° swivel function and partial extension of the tray offer outstanding ease of use. All utensils and supplies are within easy reach. The highly effective use of storage space is also enhanced by the flat design of the tray.



TurnMotion shelf III

With the TurnMotion III rotating fitting, you have all your supplies, spices, and kitchen utensils within easy reach thanks to its 360° rotation function.

- fits a 600 mm wide cabinet
- load capacity up to 20 kg
- non-slip surface
- 66.2 x 481 x 481 mm (H x W x D)

8031198 anthracite

€ 176.47

Cabinet equipment

Cabinet
equipment

STOREX®

Equipment for tall cabinets

Convenient and easy access



Pullouts for tall cabinets
For the record Page 583–588

Storage systems
A variety of items perfectly sorted Page 589–594

STOREX®

Pullouts for tall cabinets

For the record



-  VS TAL Side Page 584
- VS TAL Larder Page 585–586
- VS TAL Gate Page 587–588



VS TAL Side

The VS TAL Side pull-out allows you to make maximum use of the storage space in a 300 mm wide cabinet.

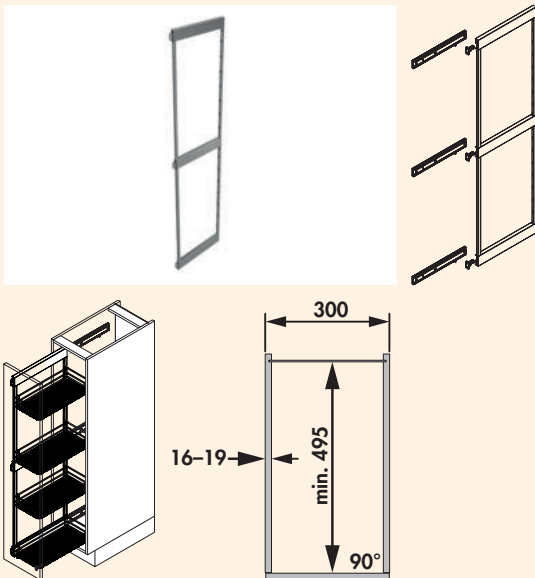

VS TAL Side frame

Pull-out drawer incl. runners.

- cabinet width 300 mm
- installation depth min. 495 mm
- installation height min. 1222 or 1824 mm
- end stop left or right
- 3 runners
- integrated damping and self-closing in the runners
- load capacity of the system: max. 40 kg
- individual height adjustment of the baskets
- 3D front adjustment
- tool-free mounting of the front on the drawer

Please note:

Baskets need to be ordered separately!

8037008	H 1222 mm, for 4 baskets, silver	€ 229.86
8037009	H 1824 mm, for 6 baskets, silver	€ 251.46
8037149	H 1222 mm, for 4 baskets, anthracite	€ 229.86
8037150	H 1824 mm, for 6 baskets, anthracite	€ 251.46



VS SUB/TAL Side Premea basket set

Storage elements for VS SUB/TAL Side frame.

- basket dimensions 84 x 220 x 470 mm (H x W x D)
- suitable for cabinet width 300 mm
- set consisting of two baskets
- rail silver, shelf grey, thickness 8 mm
- rail anthracite, shelf anthracite, thickness 8 mm

8037010	silver	€ 123.84
8037148	anthracite	€ 123.84



VS TAL Larder

The VS TAL Larder is a classic apothecary cabinet. It allows well-conceived storage and organising of food in the kitchen. When open, the VS Tal Larder provides a good overview and quick access to the contents of the cabinet.

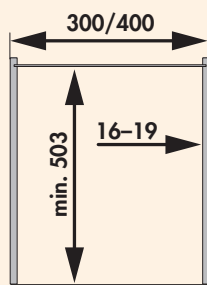
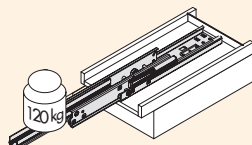

VS TAL Larder runners

For tall cupboard pull-out VS TAL Larder.

- for 300 and 400 mm cabinet widths
- top and bottom runners
- installation depth min. 503 mm
- load capacity max. 120 kg
- drawer runner with synchronisation, self closing and damping

Please note:

Support frame and baskets need to be ordered separately!

8037014	light grey	€ 181.07
8037152	anthracite	€ 181.07

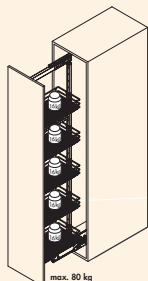

VS TAL Larder frame

For tall cupboard pull-out VS TAL Larder.

- cabinet width 300 and 400 mm
- installation depth min. 503 mm
- installation height 1200 to 2140 mm
- support frame height telescopic
- tool-free mounting of the frame on the lower and upper runners
- load capacity max. 80 Kg
- individual height adjustment of the baskets
- 3D front adjustment

Please note: Runners and baskets need to be ordered separately!

8037015	H 1200–1450 mm, up to 4 baskets, silver	€ 178.25
8037016	H 1450–1700 mm, up to 4 baskets, silver	€ 193.27
8037017	H 1700–1950 mm, up to 5 baskets, silver	€ 208.27
8037018	H 1900–2140 mm, up to 5 baskets, silver	€ 217.66

8037153	H 1200–1450 mm, up to 4 baskets, anthracite	€ 178.25
8037154	H 1450–1700 mm, up to 4 baskets, anthracite	€ 193.27
8037155	H 1700–1950 mm, up to 5 baskets, anthracite	€ 208.27
8037156	H 1900–2140 mm, up to 5 baskets, anthracite	€ 217.66

Cabinet equipment



VS TAL Larder Premea basket

Storage elements for VS TAL Larder frame.

- basket width 250 mm for 300 mm cabinet width
- basket width 350 mm for 400 mm cabinet width
- basket dimensions 80 x 250/350 x 460 mm (H x W x D)
- including attachment clip
- load capacity max. 16 kg per basket
- rail silver, shelf grey, thickness 8 mm
- rail anthracite, shelf anthracite, thickness 8 mm

8037019	300 mm cabinet, 1 pc., silver	€ 62.75
----------------	-------------------------------	---------

8037020	300 mm cabinet, 4 pc., silver	€ 250.49
----------------	-------------------------------	----------

8037157	300 mm cabinet, 1 pc., anthracite	€ 62.75
----------------	-----------------------------------	---------

8037158	300 mm cabinet, 4 pc., anthracite	€ 250.49
----------------	-----------------------------------	----------

8037021	400 mm cabinet, 1 pc., silver	€ 82.85
----------------	-------------------------------	---------

8037022	400 mm cabinet, 4 pc., silver	€ 326.51
----------------	-------------------------------	----------

8037159	400 mm cabinet, 1 pc., anthracite	€ 82.85
----------------	-----------------------------------	---------

8037160	400 mm cabinet, 4 pc., anthracite	€ 326.51
----------------	-----------------------------------	----------



Power-Move drive rod

System component for opening support for VS TAL Larder.

- for 300 and 400 mm cabinet widths
- max. 120 kg extension force
- reacts to pressure or tension
- simple installation on the existing pull-out
- subsequent installation possible
- 220 volt connection required

8037035	grey	€ 644.57
----------------	------	----------



VS TAL Gate

The VS Tal Gate impresses through maximum storage space, easy access and optimal overview. The VS TAL Gate sets new standards in convenience and design. Opening the revolving door automatically moves the cupboard contents towards the user in one go.

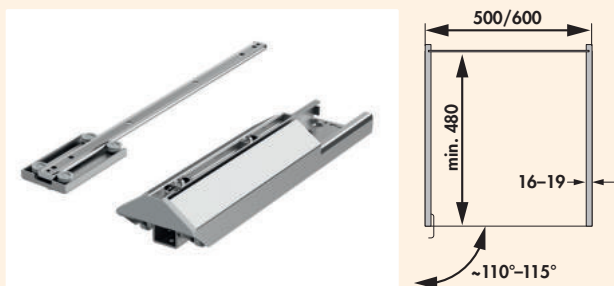

VS TAL Gate runner

For larder cupboard drawer VS TAL Gate.

- top and bottom runner
- for cabinet with revolving door
- installation depth min. 480 mm
- load capacity max. 75 kg

Please note:

Support frame and baskets need to be ordered separately!

8037036	silver	€ 181.07
8037161	anthracite	€ 181.07

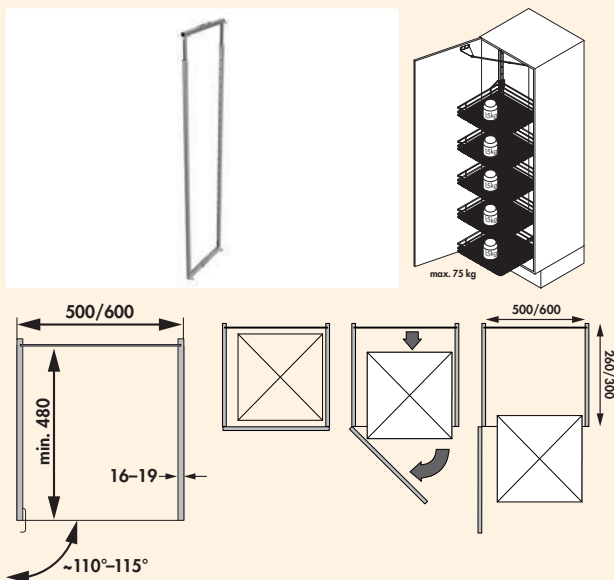

VS TAL Gate frame

For larder cupboard drawer VS TAL Gate.

- cabinet widths 500 and 600 mm
- installation depth min. 480 mm
- installation height 1700 to 2140 mm
- support frame height telescopic
- tool-free mounting of the frame on the lower runner
- tool-free connection between the cam and support frame
- load capacity of the system max. 75 kg
- individual height adjustment of the 5 baskets
- can be mounted left or right

Please note:

Runners and baskets need to be ordered separately!

8037043	500 mm cabinet, H 1700–1950 mm, up to 5 baskets, silver	€ 208.27
8037044	500 mm cabinet, H 1900–2140 mm, up to 5 baskets, silver	€ 209.24
8037162	500 mm cabinet, H 1700–1950 mm, up to 5 baskets, anthracite	€ 208.27
8037163	500 mm cabinet, H 1900–2140 mm, up to 5 baskets, anthracite	€ 209.24
8037047	600 mm cabinet, H 1700–1950 mm, up to 5 baskets, silver	€ 209.24
8037048	600 mm cabinet, H 1900–2140 mm, up to 5 baskets, silver	€ 214.86
8037164	600 mm cabinet, H 1700–1950 mm, up to 5 baskets, anthracite	€ 209.24
8037165	600 mm cabinet, H 1900–2140 mm, up to 5 baskets, anthracite	€ 214.86

Cabinet equipment



VS TAL Gate Premea basket

Storage elements for VS TAL Gate larder cupboard drawer.

- basket width 400 mm for 500 mm cabinet width
- basket width 500 mm for 600 mm cabinet width
- basket dimensions 84 x /400/500 x 395 mm (H x W x D)
- including attachment clip
- load capacity max. 16 kg per basket
- rail silver, shelf grey, thickness 8 mm
- rail anthracite, shelf anthracite, thickness 8 mm
- incl. door cam (only with basket set 4 pieces)

8037051	500 mm cabinet, 1 pc., silver	€ 100.40
8037052	500 mm cabinet, 4 pc., silver	€ 394.07
8037166	500 mm cabinet, 1 pc., anthracite	€ 100.40
8037167	500 mm cabinet, 4 pc., anthracite	€ 394.07

8037053	600 mm cabinet, 1 pc., silver	€ 103.22
8037054	600 mm cabinet, 4 pc., silver	€ 412.85
8037168	600 mm cabinet, 1 pc., anthracite	€ 103.22
8037169	600 mm cabinet, 4 pc., anthracite	€ 412.85

Cabinet equipment

STOREX®

Storage systems

A variety of items
perfectly sorted



Tidy organising system

Page 588–592

STOREX®

Tidy organisation system

The complete solution for kitchen, bath or utility room



Tidy – the storage space concept

- for tidy cupboards: everything neatly stowed and yet quickly to hand
- 60 cm wide cabinets of different heights can be individually equipped
- in just a few simple steps, components can quickly be changed, retrofitted or extended at any time
- various built-in modules that can be individually combined as required
- robust construction and durable materials for daily use
- made in Germany



Tidy organising system

The comprehensive Tidy organising system uses the storage space available in the kitchen, bathroom or utility room as efficiently as possible. Above all in flats and houses without a basement or attic, special solutions are needed to create space for storing, washing and drying clothes.



Tidy universal shelf

For various utensils (e.g. beverage crates, laundry baskets etc.). Pull-out function incl. pull-out rails.

- for 600 mm cabinet width
- corrosion-resistant coated steel sheet, white
- plastic parts white
- 68 x 568 x 510 mm (H x W x D)
- internal dimension: 445 x 500 mm (H x D)
- sidewall mounting (only suitable for 16 mm side walls)
- bearing capacity up to approx. 40 kg



8035216 white

€ 277.69



Tidy laundry basket

Laundry basket. Plastic.

- volume 41 liters
- 304 x 520 x 462 mm (H x W x D)

8035217 blue

€ 112.61



Tidy shoe rack

Built-in modules for storage of shoes.

- as attachment on universal shelf
- corrosion-resistant coated steel sheet, white
- 158 x 496 x 356 mm (H x W x D)

8035218 white

€ 167.98



Tidy utensils container

Utensils container. 2-fold with wall holder. Can be hooked in and removed.
 – for 600 mm cabinet width
 – for mounting to the outside of the cabinet or on the wall
 – corrosion-resistant coated sheet steel, white
 – plastic parts blue
 – 241 x 436 x 198 mm (H x W x D)

8035200 white/blue

€ 88.03



Tidy broom/wipe holder

2-fold.
 – corrosion-resistant coated steel sheet, white
 – 262 x 137 x 352 mm (H x W x D)
 – mounting with only four screws

8035219 white

€ 84.78



Tidy shelf

Shelf incl. dustpan and brush set.
 – corrosion-resistant coated steel sheet, white
 – 158 x 289 x 480 mm (H x W x D)
 – mounting with only four screws

8035220 white

€ 168.87



Tidy clothes dryer attachment

For attaching to the outside of the cabinet or on the wall.
 – for 600 mm cabinet width
 – corrosion-resistant coated sheet steel, white
 – folding
 – 300 x 525 x 820 mm (H x W x D)

8035209 white

€ 136.04



Tidy wall bracket

For ironing board or household ladder.
 – powder coated steel sheet, white
 – 50 x 155 x 350 mm (H x W x D)

8035215 white

€ 30.82

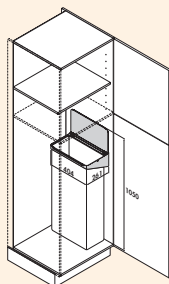

Tidy bin bag holder

Suspension device for bin bags or cloth bags.

- powder coated steel sheet
- incl. cotton sack
- installation in cabinets or outside on the cabinet wall
- mounted with only 2 screws, recommended clearance height 1050 mm
- 125 x 404 x 261 mm (H x W x D)

8035214 white

€ 220.47

Cabinet
equipment

STOREX® Accessories

Things you always need



Ladders
Supports heavy loads without
being in the way Page 595–596

Miscellaneous
What also helps Page 597–602

STOREX® Ladders

Supports heavy loads
without being in the way



Stepfix

Page 599

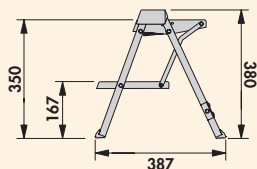

Stepfix

Folding step. Two step hinged step especially designed for use in built-in kitchens. For storage behind front pull-outs or in the base area from a height of 100 mm.

- only 90 mm deep
- **load bearing capacity ca. 150 kg**
- **step height 380 mm**
- **dimensions installation 100 x 403 x 470 mm (H x W x D)**
- **dimensions product 380 x 403 x 387 mm (H x W x D) open**

8034030 aluminium

€ 178.25



Fastening bracket

As accessories for individual base pieces. Suitable for Stepfix. Due to clip-on technology, the base may be taken off.

8034032 chrome

€ 41.95

STOREX®

Miscellaneous

What also helps



■ Stove protection grid	Page 598
Decotop	Page 599
Radios for installation	Page 600
INTUBLU	Page 601

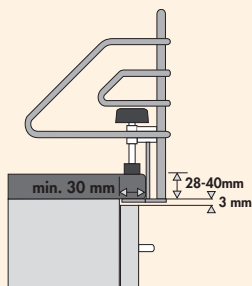

Stove protection grid

Chrome. For simple mounting on the worktop in front of a 600 mm or 900 mm hob.
 – 175 x 140 mm (H x D)

8031005	for 600 mm cabinet, W 678 mm	€ 98.65
8031008	for 900 mm cabinet, B 978 mm	€ 152.28

Cabinet equipment

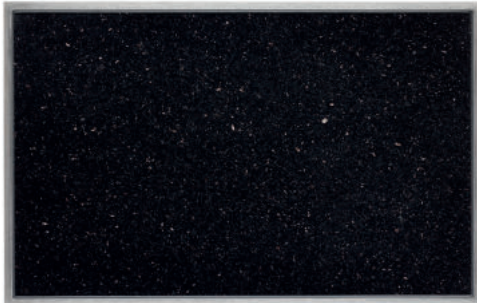

Galaxy Star

Decotop

Inserted in a stainless-steel tray form granite surface Decotop. All types of granite are expressive and high quality. So everyone can find the type that suits them, and give their creativity free rein. And all that at a convincing price.

Our tip: Damaged work surfaces, e.g. due to burn marks, can be quickly and creatively remedied.

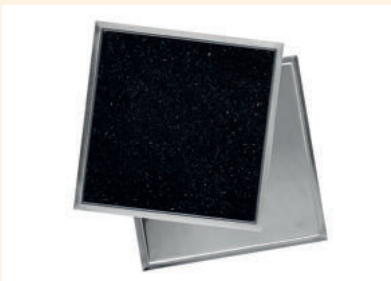

Decotop 1

- Granite section.
- dimensions 250 x 250 mm (incl. stainless-steel pan)
 - cut-out dimensions 236 x 236 mm
 - installation depth 13 mm

3012005 Galaxy Star **€ 184.31**

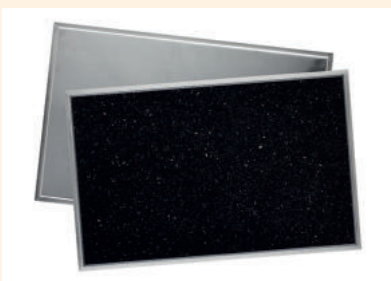

Decotop 2

- Granite section.
- dimensions 510 x 325 mm (incl. stainless-steel pan)
 - cut-out dimensions 496 x 311 mm
 - installation depth 13 mm

3012012 Galaxy Star **€ 294.02**



Fonico 2022

DAB+/VHF-RDS radio. For installation from below. With fixed station memory, dimmable LCD display, LED workstation lighting on the underside, foldable stand, two alarm times, radio or alarm tone, sleep and snooze function, two kitchen timers, incl. mains adapter, power in operation 2 x 1 watt RMS.
 – 58 x 257 x 162 mm (H x W x D)

8031219 silver € 133.40



Fonico 2045

DAB+/FM-PLL radio. For installation from below. With pre-set memory, Bluetooth® function, music streaming from mobile phone, hands-free function, LED light strips (underside of the device), kitchen timer, two alarm times can be set, timer function, incl. AD/DC mains adapter 7 V 2A. Power consumption in operation 2 x 5 watt RMS.
 – 45 x 260 x 157 mm (H x W x D)

8031218 silver € 170.28

Cabinet equipment

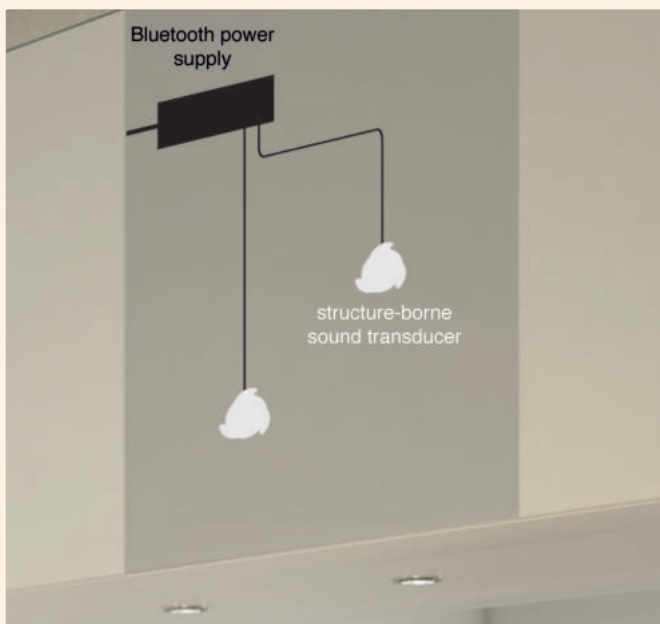
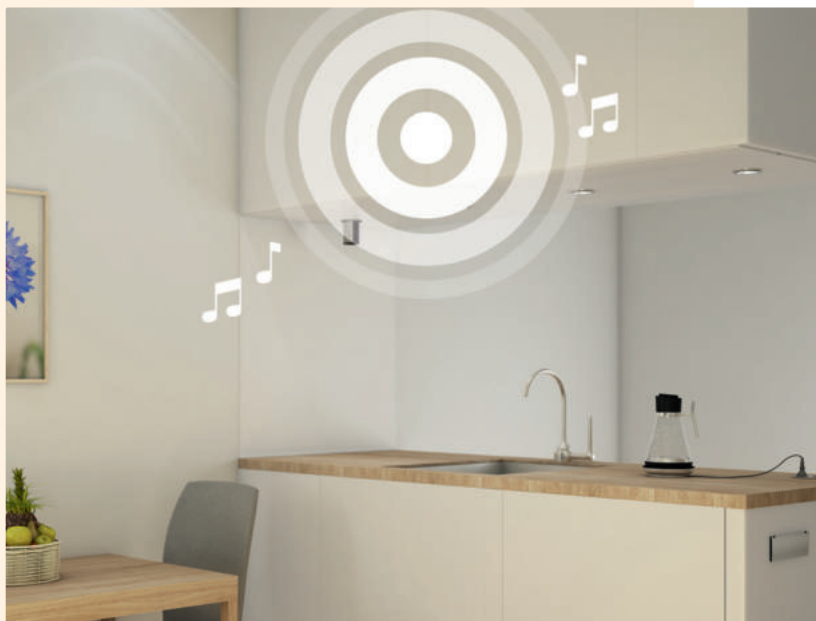

INTUBLU

INTUBLU combines music and good design. This makes visible speakers a thing of the past, because from now on, furniture in the kitchen and living room play the music. The sophisticated room concept is no longer interrupted by the appearance of inappropriate speakers. The small Exciter elements can be easily integrated into kitchen drawers, cabinet doors or behind every mirror and played via smartphone, tablet or laptop in the best sound quality.



INTUBLU

Built-in furniture speaker. With Bluetooth power supply and two structure-borne sound transducers. **For surfaces and furniture.** The invisible INTUBLU speaker system includes a Bluetooth receiver and two speakers that can be installed in furniture or on surfaces. The music is controlled and played by tablets, laptops or smartphones via Bluetooth.

Technical data:

- structure-borne sound transducer dimensions Ø 68 mm
- materia aluminium
- control via Bluetooth
- Bluetooth power supply dimensions 62 x 140 x 30 mm (H x W x D)
- radio frequency (unidirectional) 2.4. 2.83 MHz
- max. contrast load (ohm) 20 W
- max. range 10 m
- 3 screw-on points on the speaker
- appealing sound quality
- space-saving design
- cable length of the two structure-borne sound transducers 2 m | PVC connecting cable
- cable length Bluetooth power adapter 1.5 m | H03VVH2-F | 2 x 0.75 mm²
- no cables or speakers visible
- simple mounting by gluing or screwing

8031220 silver

€ 340.54

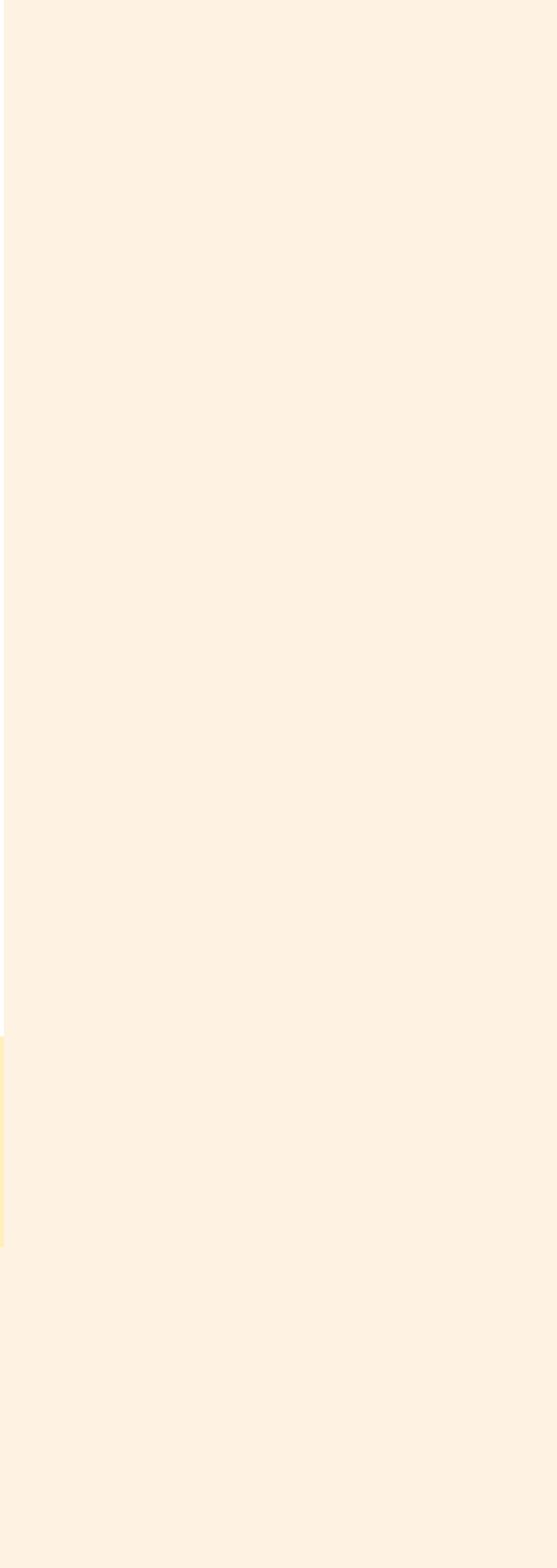

Cabinet
equipment