

SELECTAkit®

Waste  
collectors

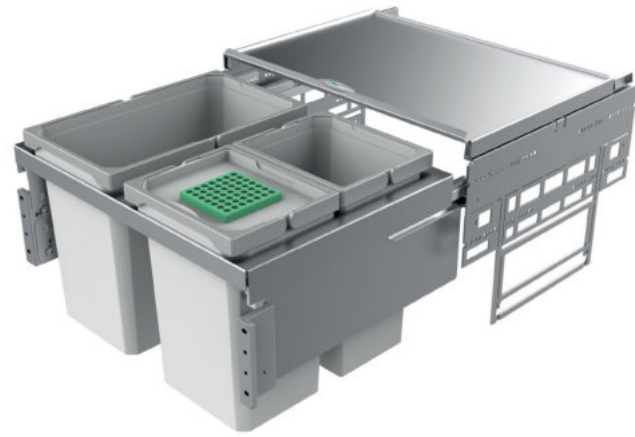

Intelligence

Waste collectors

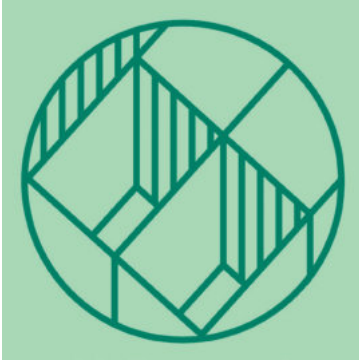

Clean waste separation conserves natural resources. At the same time, keeping the base cabinet well organised saves time and is conveniently sustainable. In this way, SELECTAkit® waste separation systems make responsible ecological thinking simple!

Because the SELECTAkit® waste collector range, creatively developed over many years, provides the optimum waste separation system with precisely fitting storage space organisation for every kitchen base unit. They are highly practical, versatile and flexible: Cox® Base, Cox StandUP®, Cox Clan®, Cabbji® ... And with Cox Base-Board® and Cox Work® you have tailor-made organisation and storage systems on top.

That means: undreamt-of storage possibilities for accessories and utensils, combined with highly functional and ergonomic design.

# SELECTAkit®

## Waste collectors

Innovative technology  
is developed from new thinking



Waste collectors



■ SELECTAkit®  
Pull-out technology for front pull-outs  
The sophisticated  
pull-out technology Page 133–170



■ SELECTAkit®  
Pull-out technology for existing pull-outs  
The flexible  
waste system Page 171–204



■ SELECTAkit®  
Pull-out technology for rotating doors  
The perfect supplement for  
functionality and ergonomics Page 205–230



■ SELECTAkit®  
Swivel technology for rotating doors  
The technology  
of shorter distances Page 231–240



■ SELECTAkit®  
Free-standing containers/  
waste disposal units  
Extremely practical  
and shapely Page 241–244

# Collectors overview

## Pull-out technology for front pull-out

Page 133–170



Full front    Front panel with one division

### Depth 320 mm

Page

Cox® Base 360 K	146–147, 149
Cox Base-Board®	141–142, 148

### Depth 400 mm

Page

Cox® Base 360 S	135–137, 143–144
Cox® Base Q+	139
Cox® Base Q	140
Cox Base-Board®	141–142, 148
Cox Base-Board® 900	145
Cox® Base 360 S/900-4	145
Cox Cick-E® 600	144
Cox Cick-E® 600 K	149
Cox® Base 460 S	150–152
Cox Cick®	153
LED foot kick Libero 3.0	153
Cox Work®	154–156
Cox® Base 360 R	157–158
Cox® Base 460 R	159–160

### Depth > 400 mm

Page

Cox Clan®	161–165
Cox Cick®	163
Bio Double 30 BM	168
Tandem 2	168
Müllex Comfort 35/5/4/4	168
Müllex Comfort 35/17/4/4	169
Müllex Oekonom 35/2/2	169
Müllex Boxx 55/60-R Bio	169
Müllex Euro Boxx 55/60 R	170
StopMatic	170
KickMatic	170

## Pull-out technology for existing pull-outs

Page 171–204



Full front    Front panel with one division    Front panel with one division    Front panel with two divisions

### Depth 310 mm

Page

Cox Stand-UP® 350 K	182–183
Cox® Box 235 K	188–190
Cox® Box 275 K	193–195

### Depth 400 mm

Page

Cox Stand-UP® 250 S	173–175
Cox Stand-UP® 280 S	176–178
Cox Stand-UP® 350 S	179–181
Cox® Box 235 S	185–187
Cox® Box 275 S	191–192
Cox® Box 360 S	197–198
Cox® Box 350 S	199–200

### Depth > 400 mm

Page

Cox® Giallo	201
X-LINE	202–203

## Pull-out technology for rotating doors

Page 205–230



Full front    Front panel with one division

	Page
Clap 1–3	206–208
Double 1/Double deluxe	209
Double 3	209
Trenta 1	210
Double Shorty/Trio Shorty	211
Double Shorty plus	212
Double 4	212
Trenta 5	212
Quarta 1	213
Double 2	213
Trenta 6	213
Bio Single 30 DT	214
Big Boy 30/40	214
Double Master/Bio Double Master	215
Trio Master/Bio Master	215–216
Double Master Maxi 40 DT	216
Bio Trio Maxi 40 DT	216
Bio Double 30 DT	217
Bio Trio DT	217
Kitchen Box	217
Solo 3635/3636	218
Tandem 7	218
Trenta 7/8	219
Cleaning agent pullout Carry	220
Tandem 7 K/S	220–222
Easy Cargo 1	223
Big Double	223
Double Master 2 DS	228
Trio Master 3 DS	229
Double 2 DS	229
Trenta 6 DS	229

### Corner solutions

Page

Corner Boy	224
Rondo plus	225–226
Rolling cart DS	227–228

# Collectors overview

## Swivel technology for rotating doors

Page 231–240



Full front

Front panel  
with one  
division

	<b>Page</b>
Cabbi® junior	232–233
Cabbi®	234–235
Cox® Beep	236
Müllex Single 35	237
Müllex Euro Flexx	237
Vario	237–238
Öko 1	239
Uno 3418	239
Duo 3416	239

## Free-standing containers, waste disposal units

Page 241–244



	<b>Page</b>
Kickboy	242
Pushboy	242
Beta	242
Alpha	243
Dassa	243
Evolution 100	244
Model 56	244



# SELECTAkit®

## Pull-out technology for front pull-out

The sophisticated  
pull-out technology



■ Cox® Base 360 S	Page 137–147	■ LED foot kick Libero 3.0	Page 153
■ Cox® Base Q	Page 138–140	■ Cox Work®	Page 154–156
■ Cox Base-Board®	Page 141–142	■ Cox® Base 360 R	Page 157–158
■ Cox® Base 360 S with Base-Board®	Page 152–144	■ Cox® Base 460 R	Page 159–160
■ Cox Cick-E® 600	Page 144	■ Cox Clan® 490	Page 161–163
■ Cox Base-Board® 900	Page 145	■ Cox Cick®	Page 163
■ Cox® Base 360 S/900-4	Page 145	■ Cox Clan® 580	Page 164–165
■ Cox® Base 360 K	Page 146–147	■ Replacement bucket and lid overview	Page 166–167
■ Cox Base-Board®	Page 148	■ Bio Double 30 BM	Page 168
■ Cox® Base 360 K with Base-Board®	Page 149	■ Tandem 2	Page 168
■ Cox Cick-E® 600 K	Page 149	■ Müllex	Page 168–170
■ Cox® Base 460 S	Page 150–152	■ StopMatic	Page 170
■ Cox Cick®	Page 153	■ KickMatic	Page 170

Suitable for the following  
front layouts:



Full front



Front panel  
with one  
division

Please check the heights of the product groups.

# SELECTAkit®

## Pull-out technology with front pull-out

### COX® Base

is the sophisticated built-in waste collector solution, convincing due to high quality, convenient handling and perfect pull-out technology.

- GRASS self-retractable full pull-out technology with synchronization, Airmatic soft-impact proven in long-term tests
- smooth operation and lateral stability even under full load (load bearing capacity 40 kg)
- reinforced metal housing frame for container holder, powder-coated
- extractable metal lid with grip clip, may be used as an additional deposit, powder-coated
- available for four cupboard widths as well as with standard and XXL containers, installation depth of only 400 mm
- optional 10 l container with bio-lid and activated charcoal filter
- exactly fitting assembly using the "quick & easy" quick assembly frame

Cox® Base – competitive edge due to perfectly attenuated pull-out technology



### Cox® Base convinces due to easy assembly:



1. Insert GRASS-guide 470 mm into the side part and assemble flush with the body (quick & easy).



2. Slide depositing lid into the plastic sliding bearing.



3. Insert pull-out frame into the pull-out rails.



4. Install front attachment using the template.



5. Insert front plate into the pull-out frame and fasten it.



6. Insert container. Finished!





### Cox® Base 360 S

Waste collector as front pull-out system with soft retraction and damping.

- installation height 360 mm
- installation depth 400 mm
- **depth of the guide rail 470 mm**
- "quick&easy" installation frame for different body thicknesses (16/19 mm)
- "nova Pro" guide rail
- functional design

Container fitting system/litres					
Cabinet/body	400	450	500	600	900
	10 10		16 10 10	10 22 10	22 22 10 10
	22	16 16	16 22	22 22	2,7 2,7 1,2 1,2
				10 10 10 10	

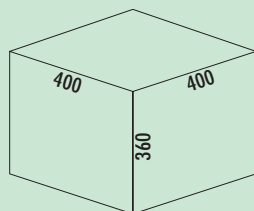

### Cox® Base 360 S/400-1

With pull-out complete lid.

- guide rail depth 470 mm
- waste capacity 22 liters
- technology: full drawer
- fitting: cabinet wall and front panel
- **with soft retraction and damping**
- **suitable for Cox Work® utensils box (see catalogue 1 pages 154–156/24 EN)**

8012310	light grey, H 360 mm	300.00 €
8013310	anthracite, H 360 mm	300.00 €

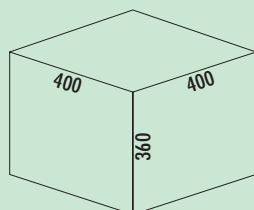
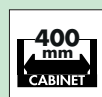

### Cox® Base 360 S/400-2

With pull-out complete lid.

- guide rail depth 470 mm
- waste capacity 20 (2 x 10) liters
- technology: full pull-out
- fitting: cabinet wall and front panel
- **with soft retraction and damping**

8012300	without bio lid, light grey, H 360 mm	300.00 €
8013300	without bio lid, anthracite, H 360 mm	300.00 €
8012313	with bio lid, light grey, H 360 mm	304.56 €
8013313	with bio lid, anthracite, H 360 mm	304.56 €

#### Optional accessories

8011312	Bio-lid, light grey, for 4/ 6/ 7/ 10/ 12.5 liters	14.79 €
8013312	Bio-lid, anthracite, for 4/ 6/ 7/ 10/ 12.5 liters	14.79 €
8011178	Bio-filter retrofitting set, black	7.39 €

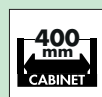

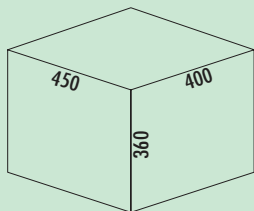

## Cox® Base 360 S/450-2

- With pull-out complete lid.
- guide rail depth 470 mm
  - waste capacity 32 (2 x 16) liters
  - technology: full pull-out
  - fitting: cabinet wall and front panel
  - **with soft retraction and damping**

8012301 light grey, H 360 mm **317.14 €**

8013301 anthracite, H 360 mm **317.14 €**

### Optional accessories

8012367 Cox Cick®, dark grey/chrome matt **66.47 €**

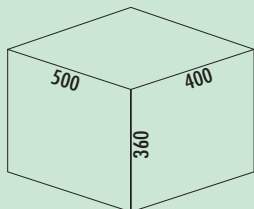

## Cox® Base 360 S/500-2

- With pull-out complete lid.
- guide rail depth 470 mm
  - waste capacity 38 (1 x 16/1 x 22) liters
  - technology: full pull-out
  - fitting: cabinet wall and front panel
  - **with soft retraction and damping**
  - **suitable for Cox Work® utensils box (see catalogue 1 pages 154–156/24 EN)**

8012303 light grey, H 360 mm **325.21 €**

8013303 anthracite, H 360 mm **325.21 €**

### Optional accessories

8012367 Cox Cick®, dark grey/chrome matt **66.47 €**

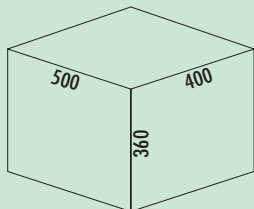

## Cox® Base 360 S/500-3

- With pull-out complete lid.
- guide rail depth 470 mm
  - waste capacity 36 (2 x 10/1 x 16) liters
  - technology: full pull-out
  - fitting: cabinet wall and front panel
  - **with soft retraction and damping**

8012302 without bio lid, light grey, H 360 mm **325.21 €**

8013302 without bio lid, anthracite, H 360 mm **325.21 €**

8012314 with bio lid, light grey, H 360 mm **329.80 €**

8013314 with bio lid, anthracite, H 360 mm **329.80 €**

### Optional accessories

8011312 Bio-lid, light grey, for 4/ 6/ 7/ 10/ 12.5 liters **14.79 €**

8013312 Bio-lid, anthracite, for 4/ 6/ 7/ 10/ 12.5 liters **14.79 €**

8011178 Bio-filter retrofitting set, black **7.39 €**

8012367 Cox Cick®, dark grey/chrome matt **66.47 €**

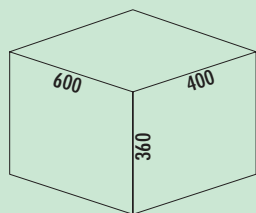

### Cox® Base 360 S/600-2

With pull-out complete lid.

- guide rail depth 470 mm
- waste capacity 44 (2 x 22) liters
- technology: full pull-out
- fitting: cabinet wall and front panel
- **with soft retraction and damping**
- suitable for Cox Work® utensils box (see catalogue 1 pages 154–156/24 EN)

8012304	light grey, H 360 mm	325.21 €
8013304	anthracite, H 360 mm	325.21 €

#### Optional accessories

8012368	Cox Cick-E® 600, W 600 mm, dark grey/chrome matt	469.83 €
8012367	Cox Cick®, dark grey/chrome matt	66.47 €

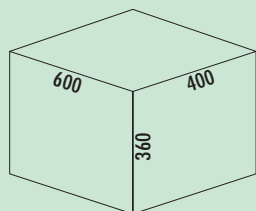
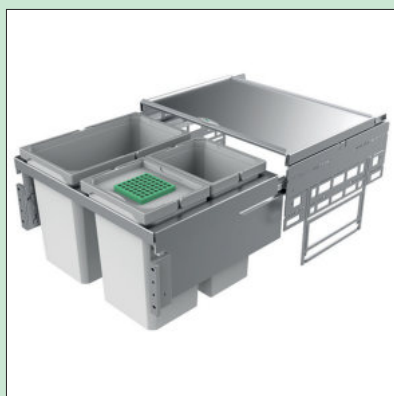

### Cox® Base 360 S/600-3

With pull-out complete lid.

- guide rail depth 470 mm
- waste capacity 42 (2 x 10/1 x 22) liters
- technology: full pull-out
- fitting: cabinet wall and front panel
- **with soft retraction and damping**
- suitable for Cox Work® utensils box (see catalogue 1 pages 154–156/24 EN)

8012305	without bio lid, light grey, H 360 mm	326.05 €
8013305	without bio lid, anthracite, H 360 mm	326.05 €
8012315	with bio lid, light grey, H 360 mm	340.84 €
8013315	with bio lid, anthracite, H 360 mm	340.84 €

#### Optional accessories

8011312	Bio-lid, light grey, for 4/ 6/ 7/ 10/ 12.5 liters	14.79 €
8013312	Bio-lid, anthracite, for 4/ 6/ 7/ 10/ 12.5 liters	14.79 €
8011178	Bio-filter retrofitting set, black	7.39 €
8012368	Cox Cick-E® 600, W 600 mm, dark grey/chrome matt	469.83 €
8012367	Cox Cick®, dark grey/chrome matt	66.47 €

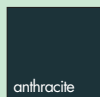
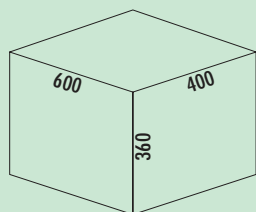

### Cox® Base 360 S/600-4

With pull-out complete lid.

- guide rail depth 470 mm
- waste capacity 40 (4 x 10) liters
- technology: full pull-out
- fitting: cabinet wall and front panel
- **with soft retraction and damping**

8012316	without bio lid, light grey, H 360 mm	365.63 €
8013316	without bio lid, anthracite, H 360 mm	365.63 €
8012317	with bio lid, light grey, H 360 mm	368.06 €
8013317	with bio lid, anthracite, H 360 mm	368.06 €

#### Optional accessories

8011312	Bio-lid, light grey, for 4/ 6/ 7/ 10/ 12.5 liters	14.79 €
8013312	Bio-lid, anthracite, for 4/ 6/ 7/ 10/ 12.5 liters	14.79 €
8011178	Bio-filter retrofitting set, black	7.39 €
8012368	Cox Cick-E® 600, W 600 mm, dark grey/chrome matt	469.83 €

# SELECTAkit®

## Uittrektechniek met frontuittreksysteem

### Cox® Base Q+/ Cox® Base Q

Afvalverzamelersystemen van Naber combineren een optimale organisatie van de opbergruimte met maximaal comfort bij de hantering. Cox® Base Q+ / Cox® Base Q maakt het mogelijk dat afvalcontainers en Quooker waterreservoirs plaatsbesparend in de onderkast van de spoelunit ondergebracht worden.

Het comfortabele tappen van kokend heet en gekoeld sprankelend water gewoon door de Quooker kraan te bedienen, is gebaseerd op waterreservoir plus slangen en wateraansluitingen. Met Cox® Base Q+ / Cox® Base Q vindt de uitrusting een plekje in een stabiel frame naast de afvalverzamelaars.

Cox® Base Q+ / Cox® Base Q biedt minstens 20 liter afvalvolume. In één variant is de draagbare box voor benodigheden Cox Work® te integreren, in een andere het speciale deksel voor composteerbaar biologisch afval. Het afvalstelsel is uitgerust met een compleet deksel, waarop er benodigheden opgeborgen kunnen worden.



- onderbrenging van het reservoir voor kokend water Quooker PRO3, COMBI, COMBI+ en van het reservoir voor koud water Quooker CUBE met CO<sub>2</sub>-cilinder
- inclusief een ordehulpmiddel voor de kabel- en slanggeleiding
- met een afzonderlijke houder voor de Quooker waterfilter
- voor 600 mm brede onderkasten
- techniek: compleet uittreksysteem met soft intreksysteem en demping
- kleur van frame/onderstel/geleider/compleet deksel: antraciet
- montage aan kastwand, kastbodem en frontpaneel
- aansluiting van het Quooker reservoir en van de kraan op het hoekventiel vindt plaats vóór het meubel. Daarna wordt het frame-element met CUBE, PRO3 reservoir, COMBI, COMBI+ en CO<sub>2</sub>-cilinder ingeschoven en door schroeven bevestigd.
- eenvoudige demontage door het losdraaien van twee schroeven voor onderhoudswerkzaamheden



Cox® Base Q+ 360 S/370-1



Cox® Base Q 360 S/400-2



### Cox® Base Q+

Quooker®

The Cox®-Base-Q+ system is ideally suited for mounting a Cox® Base 360 S together with the Quooker CUBE, PRO3, COMBI and COMBI+. The perfectly coordinated modules provide for the space-saving arrangement of all the necessary components in a sink base unit in a **600 mm wide** sink base unit.

The fitting is carried out in just a few steps, and it is possible to respond to the given installation situation with maximum flexibility. In the rear area there is sufficient space for water connections as well as hose and cable routing. **In addition, the reservoirs can be positioned on the left or on the right of the Cox® Base.**

A holder to accommodate the cube filter can be ordered as an option.

Container fitting system/litres	
Cabinet body	600

Waste collectors

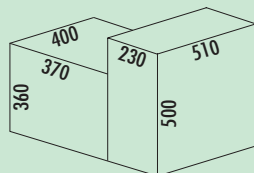

### Cox® Base Q+ 360 S/370-1

Quooker®

For positioning in a sink base unit with a **width of 600 mm.**

- **simple, quick and flexible installation**
- **positioning of the reservoirs on the left or on the right of the Cox® Base possible**
- sturdy construction for mounting on the cabinet side wall, front panel and on the underside
- integrated hose and cable management
- simple replacement of the CO<sub>2</sub> cylinder
- Quooker system can be set up and connected **in front of the cabinet. The extension hoses required for this are listed below as accessories and can be ordered directly from Quooker.**
- waste volume 22 litres
- **waste system with soft retraction and damping**

**8013378** anthracite, H 360 mm **498.33 €**

#### Optional accessories

**1051017** Space-saving connector, white **5.63 €**

**8013367** Holder for CUBE filter, anthracite **68.07 €**

**VERLEQ60** extension of the boiling water hose from the PRO3 to the tap, 600 mm

**VERLCUBE** extension of the supply line CUBE, 1500 mm

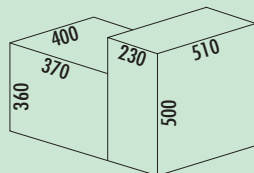

### Cox® Base Q+ 360 S/370-2

Quooker®

For positioning in a sink base unit with a **width of 600 mm.**

- **simple, quick and flexible installation**
- **positioning of the reservoirs on the left or on the right of the Cox® Base possible**
- sturdy construction for mounting on the cabinet side wall, front panel and on the underside
- integrated hose and cable management
- simple replacement of the CO<sub>2</sub> cylinder
- Quooker system can be set up and connected **in front of the cabinet. The extension hoses required for this are listed below as accessories and can be ordered directly from Quooker.**
- waste volume 20 (2 x 10) litres
- **waste system with soft retraction and damping**

**8013379** anthracite, H 360 mm **498.33 €**

#### Optional accessories

**8013312** Bio-lid, anthracite, for 4/ 6/ 7/ 10/ 12.5 liters **14.79 €**

**1051017** Space-saving connector, white **5.63 €**

**8013367** Holder for CUBE filter, anthracite **68.07 €**

**VERLEQ60** extension of the boiling water hose from the PRO3 to the tap, 600 mm

**VERLCUBE** extension of the supply line CUBE, 1500 mm

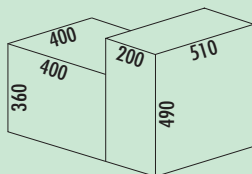

### Cox® Base Q 360 S/400-1

Quooker®

For positioning in a sink base unit with a width of 600 mm.

- simple, quick and flexible installation
- positioning of the reservoirs on the left or on the right of the Cox® Base possible
- sturdy construction for mounting on the cabinet side wall, front panel and on the underside
- integrated hose and cable management
- simple replacement of the CO<sub>2</sub> cylinder
- Quooker system can be set up and connected in front of the cabinet. The extension hoses required for this are listed below as accessories and can be ordered directly from Quooker.
- waste volume 22 litres
- waste system with soft retraction and damping

8013347 anthracite, H 360 mm 498.33 €

#### Optional accessories

1051017 Space-saving connector, white 5.63 €

8013367 Holder for CUBE filter, anthracite, anthracite 68.07 €

VERIKALT supply line extension for the PRO3, 700 mm

VERLEQ60 extension of the boiling water hose from the PRO3 to the tap, 600 mm

VERICUBE extension of the supply line CUBE, 1500 mm

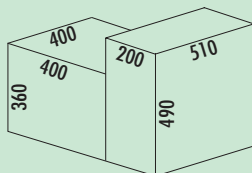

### Cox® Base Q 360 S/400-2

Quooker®

For positioning in a sink base unit with a width of 600 mm.

- simple, quick and flexible installation
- positioning of the reservoirs on the left or on the right of the Cox® Base possible
- sturdy construction for mounting on the cabinet side wall, front panel and on the underside
- integrated hose and cable management
- simple replacement of the CO<sub>2</sub> cylinder
- Quooker system can be set up and connected in front of the cabinet. The extension hoses required for this are listed below as accessories and can be ordered directly from Quooker.
- waste volume 20(2 X 10) litres
- waste system with soft retraction and damping

8013348 anthracite, H 360 mm 498.33 €

#### Optional accessories

8013312 Bio-lid, anthracite, for 4/ 6/ 7/ 10/ 12.5 liters 14.79 €

1051017 Space-saving connector, white 5.63 €

8013367 Holder for CUBE filter, anthracite, anthracite 68.07 €

VERIKALT supply line extension for the PRO3, 700 mm

VERLEQ60 extension of the boiling water hose from the PRO3 to the tap, 600 mm

VERICUBE extension of the supply line CUBE, 1500 mm

# SELECTAkit®

## Pull-out technology with front pull-out

### COX Base-Board®

Cox Base Board® is a perfect supplement to the Cox® Base waste collector, convincing due to high quality, convenient handling and perfect pull-out technology.

- GRASS self-retracting full pull-out technology with self-closing and Airmatic soft-impact proven in long-term tests
- smooth operation and lateral stability even under full load
- stable metal frame, powder-coated
- optimum fit of the plastic containers
- perfect use of space in the base cabinet due to flexible positioning of the containers
- available for cupboard widths 500 mm, 600 mm and 900 mm
- exactly fitting assembly using the "quick & easy" assembly plate, also suitable for the retrofitting of existing Cox® Base waste collectors

Cox Base-Board® – competitive edge due to perfectly attenuated pull-out technology!



Waste collectors

### Cox Base-Board® convinces due to easy assembly:



1. Pull out the depositing lid of the existing Cox® Base waste system.



2. Insert GRASS guide into the mounting plate, attach to the existing Cox® Base plastic rail and mount flush to the body ("quick & easy").



3. Replace the depositing lid of the existing Cox® Base waste system.



4. Mount the metal frame on the pull-out rails.



5. Attach container to the metal frame with the supplied brackets.



6. Mount the pull-out frame on the pull-out rails with the front connection. Finished!



## Cox Base-Board®

Cox Base Board® is a perfect supplement to the Cox® Base waste collector, convincing due to high quality, convenient handling and perfect pull-out technology:

- H 100 mm
- **depth of the guide rail 470 mm**
- GRASS self-retracting full pull-out technology with Airmatic soft-impact, proven in long-term tests
- smooth operation and lateral stability even under full load
- stable metal frame, powder-coated
- optimal utilisation of space of storage boxes by flexible positioning of the boxes by means of separate brackets
- available for cupboard widths 500, 600 and 900 mm
- exactly fitting assembly using the "quick & easy" assembly plate, also suitable for the retrofitting of existing Cox® Base waste collectors

Cox Base-Board® – competitive edge due to perfectly attenuated pull-out technology!

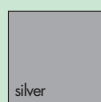
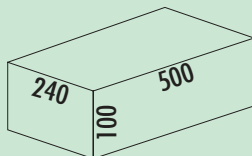

## Cox Base-Board® 500

- height 100 mm
- guide rail depth 470 mm
- 1 x 2.7 l and 1 x 1.2 l storage boxes and 4 brackets included
- uniform design to Cox® Base
- technology: full pull-out
- fitting: cabinet wall
- **with soft retraction and damping**

8012360 silver	222.77 €
8013360 anthracite	222.77 €

### Optional accessories

8012362 Storage box, dark grey, 2.7 liters	13.87 €
8013362 Storage box, anthracite, 2.7 liters	13.87 €
8012363 Storage box, dark grey, 1.2 liters	11.51 €
8013363 Storage box, anthracite, 1.2 liters	11.51 €
8012364 Bracket for storage box, silver	2.10 €

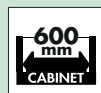
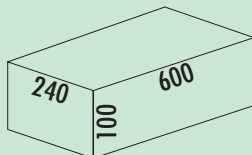

## Cox Base-Board® 600

- height 100 mm
- guide rail depth 470 mm
- 1 x 2.7 l and 1 x 1.2 l storage boxes and 4 brackets included
- uniform design to Cox® Base
- technology: full pull-out
- fitting: cabinet wall
- **with soft retraction and damping**

8012361 silver	222.77 €
8013361 anthracite	222.77 €

### Optional accessories

8012362 Storage box, dark grey, 2.7 liters	13.87 €
8013362 Storage box, anthracite, 2.7 liters	13.87 €
8012363 Storage box, dark grey, 1.2 liters	11.51 €
8013363 Storage box, anthracite, 1.2 liters	11.51 €
8012364 Bracket for storage box, silver	2.10 €



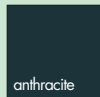
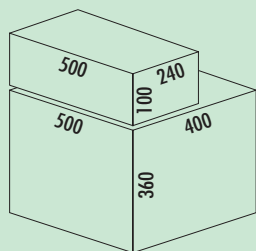

### Cox® Base 360 S/500-2 with Base-Board

- guide rail depth 470 mm
- waste capacity 38 (1 x 16/1 x 22) liters
- technology: full pull-out
- fitting: cabinet wall and front panel
- **with soft retraction and damping**
- **1 x 2.7 l and 1 x 1.2 l storage boxes and 4 brackets included**

8012370 light grey, H 460 mm 512.36 €

8013370 anthracite, H 460 mm 512.36 €

#### Optional accessories

8012367 Cox Cick®, dark grey/chrome matt 66.47 €

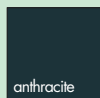
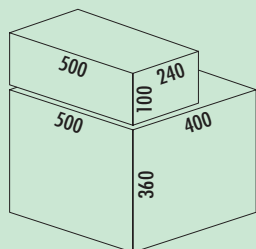
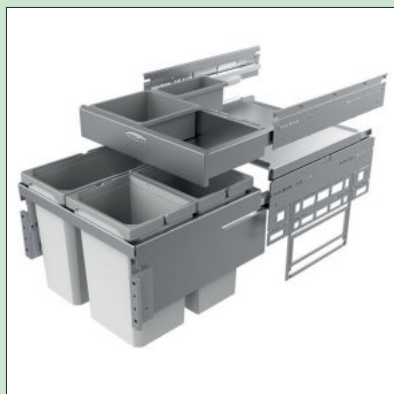

### Cox® Base 360 S/500-3 with Base-Board

- guide rail depth 470 mm
- waste capacity 36 (2 x 10/1 x 16) liters
- technology: full pull-out
- fitting: cabinet wall and front panel
- **with soft retraction and damping**
- **1 x 2.7 l and 1 x 1.2 l storage boxes and 4 brackets included**

8012371 without bio lid, light grey, H 460 mm 512.36 €

8013371 without bio lid, anthracite, H 460 mm 512.36 €

8012372 with bio lid, light grey, H 460 mm 524.78 €

8013372 with bio lid, anthracite, H 460 mm 524.78 €

#### Optional accessories

8011312 Bio-lid, light grey, for 4/ 6/ 7/ 10/ 12.5 liters 14.79 €

8013312 Bio-lid, anthracite, for 4/ 6/ 7/ 10/ 12.5 liters 14.79 €

8012367 Cox Cick®, dark grey/chrome matt 66.47 €

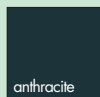
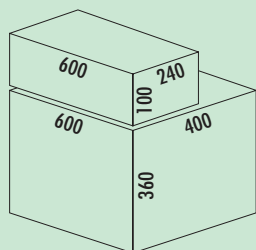

### Cox® Base 360 S/600-2 with Base-Board

- guide rail depth 470 mm
- waste capacity 44 (2 x 22) liters
- technology: full pull-out
- fitting: cabinet wall and front panel
- **with soft retraction and damping**
- **1 x 2.7 l and 1 x 1.2 l storage boxes and 4 brackets included**
- **suitable for Cox Work® utensils box (see catalogue 1 pages 154–156/24 EN)**

8012373 light grey, H 460 mm 523.32 €

8013373 anthracite, H 460 mm 523.32 €

#### Optional accessories

8012368 Cox Cick-E® 600, W 600 mm, dark grey/chrome matt 469.83 €

8012367 Cox Cick®, dark grey/chrome matt 66.47 €

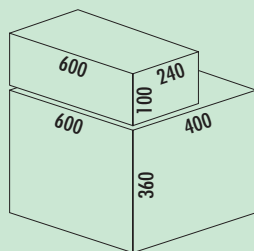

## Cox® Base 360 S/600-3 with Base-Board

- guide rail depth 470 mm
- waste capacity 42 (2 x 10/1 x 22) liters
- technology: full pull-out
- fitting: cabinet wall and front panel
- **with soft retraction and damping**
- **1 x 2.7 l and 1 x 1.2 l storage boxes and 4 brackets included**
- **suitable for Cox Work® utensils box (see catalogue 1 pages 154–156/24 EN)**

8012374	without bio lid, light grey, H 460 mm	524.12 €
8013374	without bio lid, anthracite, H 460 mm	524.12 €
8012375	with bio lid, light grey, H 460 mm	541.07 €
8013375	with bio lid, anthracite, H 460 mm	541.07 €

### Optional accessories

8011312	Bio-lid, light grey, for 4/ 6/ 7/ 10/ 12.5 liters	14.79 €
8013312	Bio-lid, anthracite, for 4/ 6/ 7/ 10/ 12.5 liters	14.79 €
8012368	Cox Cick-E® 600, W 600 mm, dark grey/chrome matt	469.83 €
8012367	Cox Cick®, dark grey/chrome matt	66.47 €

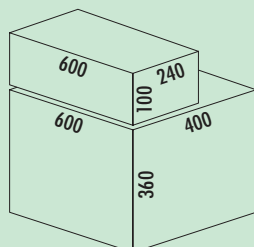
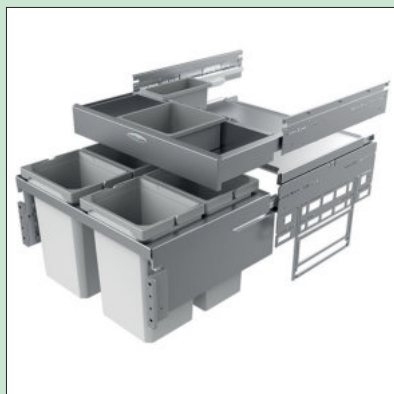

## Cox® Base 360 S/600-4 with Base-Board

- guide rail depth 470 mm
- waste capacity 40 (4 x 10) liters
- technology: full drawer
- fitting: cabinet wall and front panel
- **with soft retraction and damping**
- **1 x 2.7 l and 1 x 1.2 l storage boxes and 4 brackets included**

8012376	without bio lid, light grey, H 460 mm	547.21 €
8013376	without bio lid, anthracite, H 460 mm	547.21 €
8012377	with bio lid, light grey, H 460 mm	565.49 €
8013377	with bio lid, anthracite, H 460 mm	565.49 €

### Optional accessories

8011312	Bio-lid, light grey, for 4/ 6/ 7/ 10/ 12.5 liters	14.79 €
8013312	Bio-lid, anthracite, for 4/ 6/ 7/ 10/ 12.5 liters	14.79 €
8012368	Cox Cick-E® 600, W 600 mm, dark grey/chrome matt	469.83 €



## Cox Cick-E® 600



- **electric ejector for Cox® waste collectors**
- **suitable for Cox® Base waste collector with 400 mm installation depth and 600 mm width**
- space-saving and invisible installation behind the waste collectors
- activation of pull-out mechanism by gently touching the pull-out front
- alternative mounting positions to avoid obstacles on site (e.g. water connection)
- attachment of the crossbar to existing holes of the Cox® waste collector
- 230 V electrical connection
- compatible waste collectors: 8012304, 8013304, 8012305, 8013305, 8012315, 8013315, 8012308, 8013308, 8012316, 8013316, 8012317, 8013317, 8012373, 8013373, 8012374, 8013374, 8012375, 8013375, 8012377, 8013377, 8012376, 8013376, 8012406, 8013406, 8012446, 8013446, 8012354, 8013354

8012368	W 600 mm, dark grey/chrome matt	469.83 €
---------	---------------------------------	----------



### Cox Base-Board®

Cox Base Board® is a perfect supplement to the Cox® Base waste collector, convincing due to high quality, convenient handling and perfect pull-out technology:

- H 100 mm
- **depth of the guide rail 470 mm**
- GRASS self-retracting full pull-out technology with Airmatic soft-impact, proven in long-term tests
- smooth operation and lateral stability even under full load
- stable metal frame, powder-coated
- optimal utilisation of space of storage boxes by flexible positioning of the boxes by means of separate brackets
- available for cupboard widths 500, 600 and 900 mm
- exactly fitting assembly using the "quick & easy" assembly plate, also suitable for the retrofitting of existing Cox® Base waste collectors

Cox Base-Board® – competitive edge due to perfectly attenuated pull-out technology!

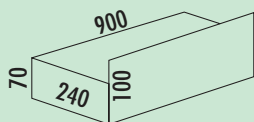

### Cox Base-Board® 900

- height 100 mm
- guide rail depth 470 mm
- 2 x 2.7 l and 2 x 1.2 l storage boxes and 4 brackets included
- uniform design to Cox® Base
- technology: full pull-out
- fitting: cabinet wall
- **with soft retraction and damping**

8012551	silver	242.52 €
8013551	anthracite	242.52 €

#### Optional accessories

8012362	Storage box, dark grey, 2.7 liters	13.87 €
8013362	Storage box, anthracite, 2.7 liters	13.87 €
8012363	Storage box, dark grey, 1.2 liters	11.51 €
8013363	Storage box, anthracite, 1.2 liters	11.51 €
8012364	Bracket for storage box, silver	2.10 €

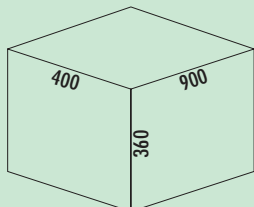
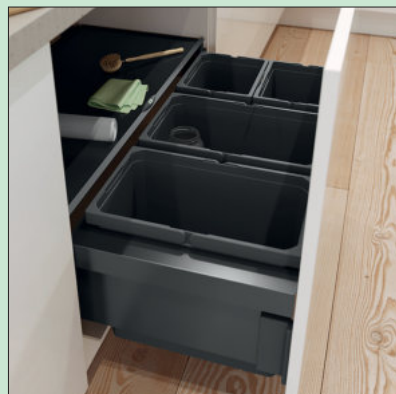

### Cox® Base 360 S/900-4

With pull-out complete lid.

- guide rail depth 470 mm
- waste capacity 64 (2 x 10/2 x 22) liters
- technology: full drawer
- fitting: cabinet wall and front panel
- **with soft retraction and damping**

8012550	without bio lid, light grey, H 360 mm	435.71 €
8013550	without bio lid, anthracite, H 360 mm	435.71 €
8012552	with bio lid, light grey, H 360 mm	447.12 €
8013552	with bio lid, anthracite, H 360 mm	447.12 €

#### Optional accessories

8011312	Bio-lid, light grey, for 4/ 6/ 7/ 10/ 12.5 liters	14.79 €
8013312	Bio-lid, anthracite, for 4/ 6/ 7/ 10/ 12.5 liters	14.79 €
8011178	Bio-filter retrofitting set, black	7.39 €
8012367	Cox Cick®, dark grey/chrome matt	66.47 €





## Cox® Base 360 K

Waste collector as front pull-out system with soft retraction and damping.

- installation height 360 mm
- **installation depth 320 mm**
- **due to the reduced depth, devices can be installed behind (e.g. boiler)**
- **depth of the guide rail 470 mm**
- "quick&easy" installation frame for various cabinet thicknesses (16/19 mm)
- "nova Pro" guide rail
- functional design

Container fitting system/litres		
Cabinet body	500	600
	12 15.5	15.5 15.5

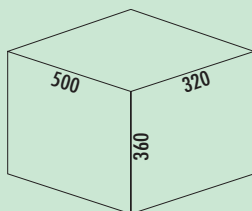

## Cox® Base 360 K/500-2

With pull-out complete lid.

- guide rail depth 470 mm
- waste capacity 27.5 (1 x 15.5/1 x 12) liters
- technology: full pull-out
- fitting: cabinet wall and front panel
- **with soft retraction and damping**
- **installation depth 320 mm**

<b>8012400</b> without bio lid, light grey, H 360 mm	<b>317.14 €</b>
<b>8013400</b> without bio lid, anthracite, H 360 mm	<b>317.14 €</b>
<b>8012401</b> with bio lid, light grey, H 360 mm	<b>326.86 €</b>
<b>8013401</b> with bio lid, anthracite, H 360 mm	<b>326.86 €</b>

### Optional accessories

<b>8012343</b> Bio-lid, light grey, for 7.5/ 9/ 12 liters	<b>16.39 €</b>
<b>8013343</b> Bio lid, anthracite, for 7.5/ 9/ 12 liters	<b>16.39 €</b>
<b>8012367</b> Cox Cick®, dark grey/chrome matt	<b>66.47 €</b>

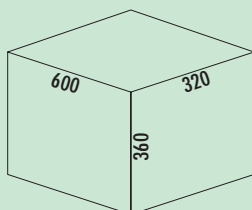

## Cox® Base 360 K/600-2

With pull-out complete lid.

- guide rail depth 470 mm
- waste capacity 31 (2 x 15.5) liters
- technology: full pull-out
- fitting: cabinet wall and front panel
- **with soft retraction and damping**
- **installation depth 320 mm**

<b>8012402</b> without bio lid, light grey, H 360 mm	<b>325.21 €</b>
<b>8013402</b> without bio lid, anthracite, H 360 mm	<b>325.21 €</b>
<b>8012403</b> with bio lid, light grey, H 360 mm	<b>335.18 €</b>
<b>8013403</b> with bio lid, anthracite, H 360 mm	<b>335.18 €</b>

### Optional accessories

<b>8012344</b> Bio-lid, light grey, for 10/ 12/ 15.5 liters	<b>16.81 €</b>
<b>8013344</b> Bio lid, anthracite, for 10/ 12/ 15.5 liters	<b>16.81 €</b>
<b>8012369</b> Cox Cick-E® 600 K, dark grey/chrome matt	<b>472.52 €</b>
<b>8012367</b> Cox Cick®, dark grey/chrome matt	<b>66.47 €</b>

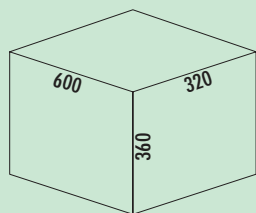

### Cox® Base 360 K/600-3

- With pull-out complete lid.
- guide rail depth 470 mm
  - waste capacity 30,5 (1 x 15.5/2 x 7.5) liters
  - technology: full pull-out
  - fitting: cabinet wall and front panel
  - **with soft retraction and damping**
  - **installation depth 320 mm**

<b>8012489</b>	without bio lid, light grey, H 360 mm	<b>325.21 €</b>
<b>8013489</b>	without bio lid, anthracite, H 360 mm	<b>325.21 €</b>
<b>8012509</b>	with bio lid, light grey, H 360 mm	<b>334.77 €</b>
<b>8013509</b>	with bio lid, anthracite, H 360 mm	<b>334.77 €</b>

#### Optional accessories

<b>8012497</b>	Bio lid, light grey, for 7.5 litres	<b>16.39 €</b>
<b>8013497</b>	Bio lid, anthracite, for 7.5 litres	<b>16.39 €</b>
<b>8012369</b>	Cox Cick-E® 600 K, dark grey/chrome matt	<b>472.52 €</b>



## Cox Base-Board®

Cox Base Board® is a perfect supplement to the Cox® Base waste collector, convincing due to high quality, convenient handling and perfect pull-out technology:

- H 100 mm
- **depth of the guide rail 470 mm**
- GRASS self-retracting full pull-out technology with Airmatic soft-impact, proven in long-term tests
- smooth operation and lateral stability even under full load
- stable metal frame, powder-coated
- optimal utilisation of space of storage boxes by flexible positioning of the boxes by means of separate brackets
- available for cupboard widths 500, 600 and 900 mm
- exactly fitting assembly using the "quick & easy" assembly plate, also suitable for the retrofitting of existing Cox® Base waste collectors

Cox Base-Board® – competitive edge due to perfectly attenuated pull-out technology!

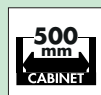
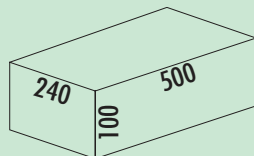

## Cox Base-Board® 500

- height 100 mm
- guide rail depth 470 mm
- 1 x 2.7 l and 1 x 1.2 l storage boxes and 4 brackets included
- uniform design to Cox® Base
- technology: full pull-out
- fitting: cabinet wall
- **with soft retraction and damping**

8012360 silver	222.77 €
8013360 anthracite	222.77 €

### Optional accessories

8012362 Storage box, dark grey, 2.7 liters	13.87 €
8013362 Storage box, anthracite, 2.7 liters	13.87 €
8012363 Storage box, dark grey, 1.2 liters	11.51 €
8013363 Storage box, anthracite, 1.2 liters	11.51 €
8012364 Bracket for storage box, silver	2.10 €

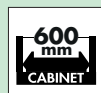
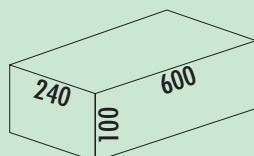

## Cox Base-Board® 600

- height 100 mm
- guide rail depth 470 mm
- 1 x 2.7 l and 1 x 1.2 l storage boxes and 4 brackets included
- uniform design to Cox® Base
- technology: full pull-out
- fitting: cabinet wall
- **with soft retraction and damping**

8012361 silver	222.77 €
8013361 anthracite	222.77 €

### Optional accessories

8012362 Storage box, dark grey, 2.7 liters	13.87 €
8013362 Storage box, anthracite, 2.7 liters	13.87 €
8012363 Storage box, dark grey, 1.2 liters	11.51 €
8013363 Storage box, anthracite, 1.2 liters	11.51 €
8012364 Bracket for storage box, silver	2.10 €

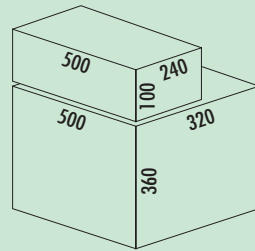
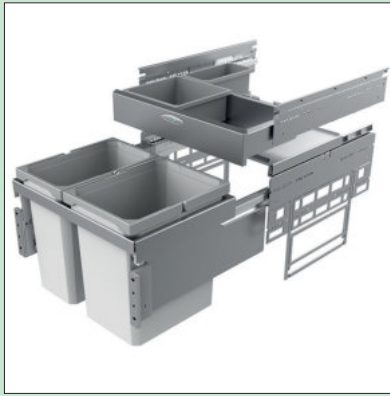

### Cox® Base 360 K/500-2 with Base-Board

- guide rail depth 470 mm
- waste capacity 27.5 (1 x 15.5/1 x 12) liters
- technology: full pull-out
- fitting: cabinet wall and front panel
- **with soft retraction and damping**
- **installation depth 320 mm**
- **1 x 2.7 l and 1 x 1.2 l storage boxes and 4 brackets included**

8012800	without bio lid, light grey, H 460 mm	506.17 €
8013800	without bio lid, anthracite, H 460 mm	506.17 €
8012801	with bio lid, light grey, H 460 mm	515.97 €
8013801	with bio lid, anthracite, H 460 mm	515.97 €

#### Optional accessories

8012343	Bio-lid, light grey, for 7.5/ 9/ 12 liters	16.39 €
8013343	Bio lid, anthracite, for 7.5/ 9/ 12 liters	16.39 €

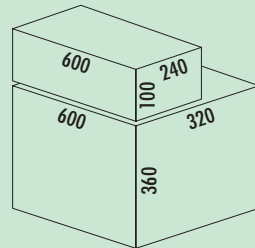
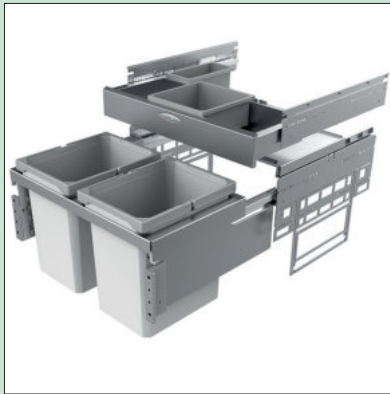

### Cox® Base 360 K/600-2 with Base-Board

- guide rail depth 470 mm
- waste capacity 31 (2 x 15.5) liters
- technology: full pull-out
- fitting: cabinet wall and front panel
- **with soft retraction and damping**
- **installation depth 320 mm**
- **1x2.7 l and 1x1.2 l storage boxes and 4 brackets included**

8012802	without bio lid, light grey, H 460 mm	524.69 €
8013802	without bio lid, anthracite, H 460 mm	524.69 €
8012803	with bio lid, light grey, H 460 mm	536.55 €
8013803	with bio lid, anthracite, H 460 mm	536.55 €

#### Optional accessories

8012344	Bio-lid, light grey, for 10/ 12/ 15.5 liters	16.81 €
8013344	Bio lid, anthracite, for 10/ 12/ 15.5 liters	16.81 €
8012369	Cox Cick-E® 600 K, dark grey/chrome matt	472.52 €



### Cox Cick-E® 600 K



- **electric ejector for Cox® waste collectors**
- suitable for Cox® Base waste collector with reduced installation depth (320 mm) and 600 mm width
- space-saving and invisible installation behind the waste collectors
- activation of pull-out mechanism by gently touching the pull-out front
- alternative mounting positions to avoid obstacles on site (e.g. water connection)
- attachment of the crossbar to existing holes of the Cox® waste collector
- 230 V electrical connection
- compatible waste collectors: 8012402, 8013402, 8012403, 8013403, 8012489, 8013489, 8012509, 8013509, 8012802, 8013802, 8012803, 8013803

8012369	dark grey/chrome matt	472.52 €
---------	-----------------------	----------



### Cox® Base 460 S

Waste collector as front pull-out system with soft retraction and damping.

- installation height 460 cm
- installation depth 400 cm
- **depth of the installation frame 470 mm**
- "quick&easy"-installation frame for different body thicknesses (16/19 mm)
- "nova Pro" guide rail
- functional design

Container fitting system/litres				
Cabinet body	400	450	500	600
	28		21 28	28 28
	12.5 12.5	21 21	21 12.5 12.5	12.5 28 12.5

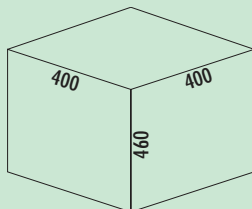

### Cox® Base 460 S/400-1

With pull-out complete lid.

- guide rail depth 470 mm
- waste capacity 28 liters
- technology: full pull-out
- frame/guide silver
- complete lid silver
- fitting: cabinet wall and front panel
- **with soft retraction and damping**
- **suitable for Cox Work® utensils box (see catalogue 1 pages 154–156/24 EN)**

8012311 light grey, H 460 mm

338.66 €

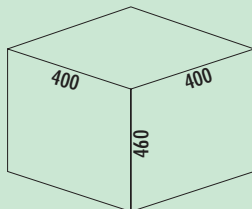
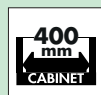

### Cox® Base 460 S/400-2

With pull-out complete lid.

- guide rail depth 470 mm
- waste capacity 25 (2 x 12.5) liters
- technology: full pull-out
- frame/guide silver
- complete lid silver
- fitting: cabinet wall and front panel
- **with soft retraction and damping**

8012356 light grey, H 460 mm

340.50 €

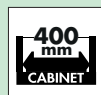



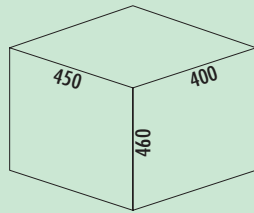

### Cox® Base 460 S/450-2

With pull-out complete lid.

- guide rail depth 470 mm
- waste capacity 42 (2 x 21) liters
- technology: full pull-out
- frame/guide silver
- complete lid silver
- fitting: cabinet wall and front panel
- **with soft retraction and damping**

8012306 light grey, H 460 mm

341.34 €

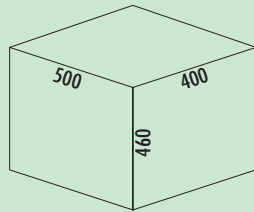

### Cox® Base 460 S/500-2

With pull-out complete lid.

- guide rail depth 470 mm
- waste capacity 49 (1 x 21/1 x 28) liters
- technology: full pull-out
- frame/guide silver
- complete lid silver
- fitting: cabinet wall and front panel
- **with soft retraction and damping**
- **suitable for Cox Work® utensils box (see catalogue 1 pages 154–156/24 EN)**

8012307 light grey, H 460 mm

348.57 €

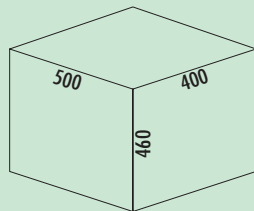

### Cox® Base 460 S/500-3

With pull-out complete lid.

- guide rail depth 470 mm
- waste capacity 46 (1 x 21/2 x 12.5) liters
- technology: full pull-out
- frame/guide silver
- complete lid silver
- fitting: cabinet wall and front panel
- **with soft retraction and damping**

8012355 light grey, H 460 mm

358.40 €

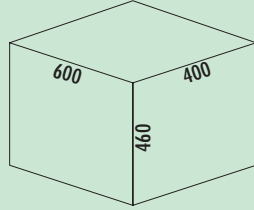

## Cox® Base 460 S/600-2

With pull-out complete lid.

- guide rail depth 470 mm
- waste capacity 56 (2 x 28) liters
- technology: full pull-out
- frame/guide silver
- complete lid silver
- fitting: cabinet wall and front panel
- **with soft retraction and damping**
- suitable for Cox Work® utensils box (see catalogue 1 pages 154–156/24 EN)

8012308	light grey, H 460 mm	346.72 €
8013308	anthracite, H 460 mm	346.72 €

### Optional accessories

8012368	Cox Cick-E® 600, W 600 mm, dark grey/chrome matt	469.83 €
---------	--	----------

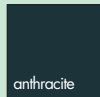
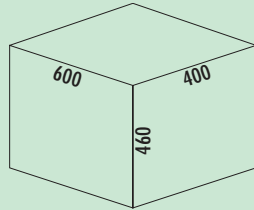

## Cox® Base 460 S/600-3

With pull-out complete lid.

- guide rail depth 470 mm
- waste capacity 53 (1 x 28/2 x 12.5) liters
- technology: full pull-out
- frame/guide silver
- complete lid silver
- fitting: cabinet wall and front panel
- **with soft retraction and damping**
- suitable for Cox Work® utensils box (see catalogue 1 pages 154–156/24 EN)

8012354	light grey, H 460 mm	356.64 €
8013354	anthracite, H 460 mm	356.64 €

### Optional accessories

8012368	Cox Cick-E® 600, W 600 mm, dark grey/chrome matt	469.83 €
---------	--	----------

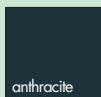

## Cox® Base single bucket

Optional accessories for all waste collectors of the group pull-out technology with front pull-out.

- waste capacity 4 liters
- 144 x 230 x 191 mm (H x W x D)

8012309	light grey	19.83 €
8013309	anthracite	19.83 €



### Bio-lid

Includes 4 activated carbon filters (assumed annual requirement) as retrofitting set for Cox® Base replacement bucket 4, 6, 7, 10 and 12.5 liters.

8011312	light grey, for 4/ 6/ 7/ 10/ 12.5 liters	14.79 €
8013312	anthracite, for 4/ 6/ 7/ 10/ 12.5 liters	14.79 €

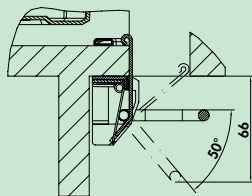

### Cox Cick®

Cox Cick® is a manual foot pedal that enables effortless access to the Cox® Base and Cox Clan® waste collectors. Thanks to the ergonomically pleasantly designed pedal position, the waste system opens completely with little force. After operation, the opening mechanism automatically returns to its original position with the aid of a spring. In this way, near-silent operation is guaranteed when opening and closing. The assembly is simple and quick due to two moulded lugs with position fixing. The necessary drilling points are easily found by means of a plastic assembly aid.

- bracket projection on 16 gauge front 34 mm
- bracket projection on 19 gauge front 31 mm

8012367	dark grey/chrome matt	66.47 €
---------	-----------------------	---------

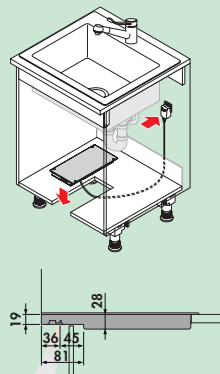
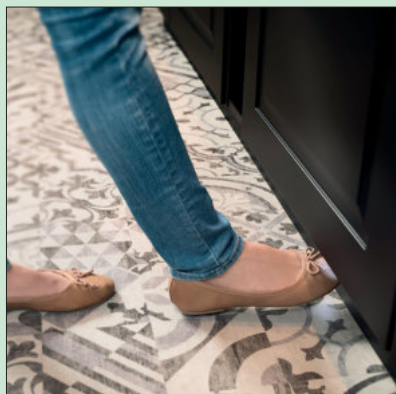

### LED foot kick Libero 3.0 with voice control

Motor-controlled ejector for all pull-outs with front extension.

**Compatible with Alexa (Amazon) voice control systems.** Installation in the front area of the bottom of the cupboard.

Required base recess from cabinet edge: ca. 50 mm, **base height min. 100 mm**

Power supply: up to 230 volts, conventional sockets with 2000 mm cable

USB-C/USB plug, drip-proof according to IP21.

- simple operation by foot sensor and/or voice control
- for base units from 300–1200 mm wide
- integrated LED indicator lighting, dimmable, can be switched off
- ejector strength adjustable, sensor sensitivity adjustable
- intelligent control, detects obstacles thanks to sliding clutch
- **product dimensions: 33 x 157 x 300 mm (H x W x D)**
- **cut-out dimensions: 127 x 286 mm (W x D)**

Setting and configuration via web browser.

8011212	white	392.02 €
---------	-------	----------

# SELECTAkit®

## Container system

### Cox Work® – all your utensils at your fingertips

The many useful little things of everyday life also need a place where they are always to hand. Cox Work® was developed as a practical kitchen aid and has quickly established itself as a well-designed standard supplementary tool in the Cox container programme.

Aesthetic and constructive "stand-alone qualities" and an intelligent division system extend the range of applications far beyond the kitchen and household. In the office, in the workshop, in the garden and in many other hobby areas, Cox Work® saves unnecessary time spent searching for the right utensil.

- Cox Work® includes the following system parts (scope varies per set): box, small part box, 2 U-dividers and 2 V-dividers
- Cox Work® can be fittingly inserted into the 13, 16, 22 and 28 litre containers of the Cox®-container system with the system dimension 230 x 382 mm (W x D)
- Cox Work® is available in the colours light grey and anthracite
- material: ABS plastic
- dimensions H x W x D 161.5 x 361 x 209 mm



### Applications

- toolbox insert for the Cox® container system
- office utensils box
- toolbox
- hobby box
- garden helper box
- BBQ cleaner box
- bottle box



reddot award 2019  
winner





### Cox Work®

Functional and well-organised storage space is becoming increasingly important, not only at the kitchen workplace. The well-designed Cox Work® utensil box is a practical organisation aid and can be intelligently used as a free-standing element or behind front pull-outs in Cox® systems for the orderly placement of various work materials and accessories.

Cox Work® is offered in three different versions:

- Version 1 includes Cox Work® Box in the desired colour.
- Version 2 includes a small parts box, in addition to the Cox Work® Box, which is elegantly fitted via the integrated handle and provides space for many little things.
- Version 3 also includes two V- and U-shaped dividers. These subdivide Cox Work® and create clearly structured storage space.

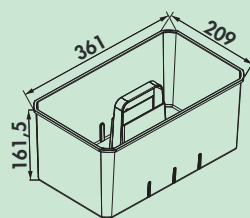
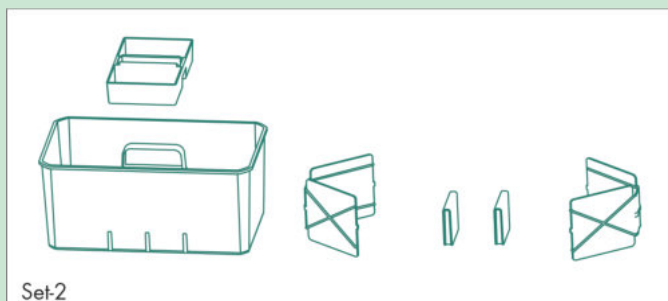
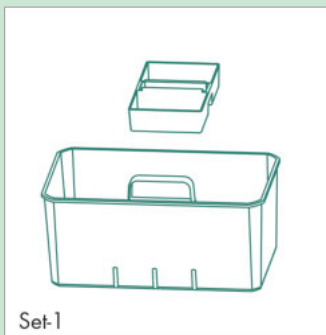

### Cox Work® Concrete

Utensil box. For storage of, e.g. brushes, cleaners, tabs and cloths.

- mobile utensil box, light grey
- various applications
- can be integrated into all Cox® container systems with Cox® system dimensions 230 x 382 mm

<b>8012530</b> Cox Work® Box	<b>57.06 €</b>
<b>8012531</b> set 1, incl. small parts box	<b>71.60 €</b>
<b>8012532</b> set 2, incl. small parts box, 2 x U-divider/V-divider	<b>118.57 €</b>

#### Optional accessories

<b>8012533</b> small parts box Concrete/Carbon	<b>16.64 €</b>
<b>8012534</b> U-divider Concrete/Carbon	<b>5.21 €</b>
<b>8012535</b> V-divider Concrete/Carbon	<b>21.85 €</b>

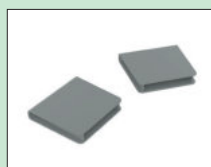

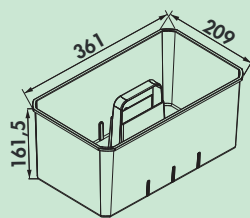

### Cox Work® Carbon

Utensil box. For storage of, e.g. brushes, cleaners, tabs and cloths.

- mobile utensil box, anthracite
- various applications
- can be integrated into all Cox® container systems with Cox® system dimensions 230 x 382 mm

<b>8012540</b> Cox Work® Box	<b>57.06 €</b>
<b>8012541</b> set 1, incl. small parts box	<b>71.60 €</b>
<b>8012542</b> set 2, incl. small parts box, 2 x U-divider/V-divider	<b>118.57 €</b>
<b>Optional accessories</b>	
<b>8012533</b> small parts box Concrete/Carbon	<b>16.64 €</b>
<b>8012534</b> U-divider Concrete/Carbon	<b>5.21 €</b>
<b>8012535</b> V-divider Concrete/Carbon	<b>21.85 €</b>



### Top frame with clamping hook for Cox® Base 360 R

Waste collector as front pull-out system with soft retraction and damping.

- installation height 360 mm
- installation depth 400 mm
- **depth of the guide rail 470 mm**
- "quick&easy" installation frame for various cabinet thicknesses (16/19 mm)
- "nova Pro" guide rail
- functional design
- **with top frame for several bags**

#### Top frame with clamping hook for Cox® base 360 R:

##### Cox® top frame with clamping hook

As a practical accessory for the large-volume waste container the optional two-piece top frame makes it possible to conveniently insert rubbish bags of various sizes into the plastic containers. Individual and practical for every requirement.

##### Cox® top frame for bag attachment

The innovative two-piece clamping frame system enables the use of different sizes of rubbish bag.

Depending on your preferences, two small or one large bag can be clamped in.

##### Mounting in a jiffy

Clip the two halves of the top frame onto the top edge of the waste collector. After inserting the rubbish bag into the container, the rubbish bag is pulled down through the support frame and fastened on the outside with the corresponding clamping hooks. Finished!

##### Especially for Swiss garbage bags

The Cox® Base 460 R waste container with top frame is ideally suited for standard Swiss garbage bags with 35 litres.

Container fitting system/litres		
Cabinet body	500	600
	29	16 29

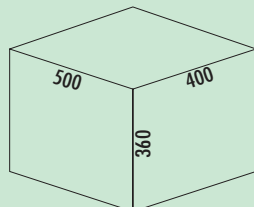

### Cox® Base 360 R/500-1

With pull-out complete lid.

- guide rail depth 470 mm
- waste capacity 29 liters
- technology: full pull-out
- frame/guide silver
- complete lid silver
- fitting: cabinet wall and front panel
- **incl. top frame for bag attachment**
- **with soft retraction and damping**

8012405 light grey, H 360 mm

340.50 €



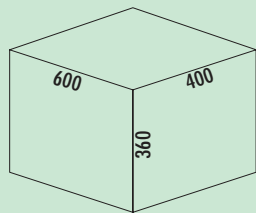

## Cox® Base 360 R/600-2

- With pull-out complete lid.
- guide rail depth 470 mm
  - waste capacity 45 (1 x 29/1 x 16) liters
  - technology: full pull-out
  - frame/guide silver
  - complete lid silver
  - fitting: cabinet wall and front panel
  - **incl. top frame for bag attachment**
  - **with soft retraction and damping**

<b>8012406</b> light grey, H 360 mm	<b>377.31 €</b>
<b>8013406</b> anthracite, H 360 mm	<b>377.31 €</b>

### Optional accessories

<b>8012368</b> Cox Cick-E® 600, W 600 mm, dark grey/chrome matt	<b>469.83 €</b>
<b>8012367</b> Cox Cick®, dark grey/chrome matt	<b>66.47 €</b>





### Cox® Base 460 R

Waste collector as front pull-out system with soft retraction and damping.

- installation height 460 mm
- installation depth 400 mm
- **depth of the guide rail 470 mm**
- "quick&easy" installation frame for various cabinet thicknesses (16/19 mm)
- "nova Pro" guide rail
- functional design
- **39 litre bucket ideal for Swiss bags (bin bags)**
- **with insertion frame for several bags**

Container fitting system/litres				
Cabinet body	400	450	500	600
	39	39	39	21 39

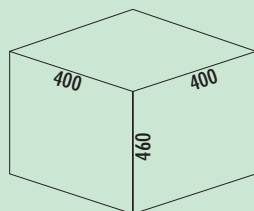

### Cox® Base 460 R/400-1

With pull-out complete lid.

- guide rail depth 470 mm
- waste capacity 39 liters
- technology: full pull-out
- frame/guide silver
- complete lid silver
- fitting: cabinet wall and front panel
- **incl. top frame for bag attachment**
- **with soft retraction and damping**

8012443 light grey, H 460 mm

344.03 €

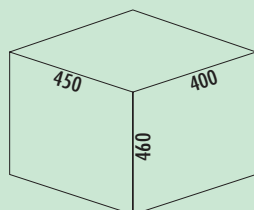

### Cox® Base 460 R/450-1

With pull-out complete lid.

- guide rail depth 470 mm
- waste capacity 39 liters
- technology: full pull-out
- frame/guide silver
- complete lid silver
- fitting: cabinet wall and front panel
- **incl. top frame for bag attachment**
- **with soft retraction and damping**

8012444 light grey, H 460 mm

344.03 €



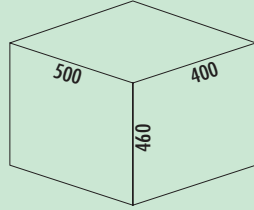

### Cox® Base 460 R/500-1

- With pull-out complete lid.
- guide rail depth 470 mm
  - waste capacity 39 liters
  - technology: full pull-out
  - frame/guide silver
  - complete lid silver
  - fitting: cabinet wall and front panel
  - **incl. top frame for bag attachment**
  - **with soft retraction and damping**

8012445 light grey, H 460 mm

344.03 €

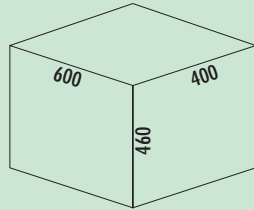

### Cox® Base 460 R/600-2

- With pull-out complete lid.
- guide rail depth 470 mm
  - waste capacity 60 (1 x 39/1 x 21) liters
  - technology: full pull-out
  - frame/guide silver
  - complete lid silver
  - fitting: cabinet wall and front panel
  - **incl. top frame for bag attachment**
  - **with soft retraction and damping**

8012446 light grey, H 460 mm

388.07 €

8013446 anthracite, H 460 mm

388.07 €

#### Optional accessories

8012368 Cox Cick-E® 600, W 600 mm, dark grey/chrome matt

469.83 €

# SELECTAkit®

## Pull-out technology for front pull-out

### Cox Clan® – Waste collectors for large waste volume

The sophisticated waste collector Cox Clan® is the continuation of the success story of the Cox® system series. As the "big brother" of the Cox® Base systems, it is ideally suited for holding high volumes of waste.

- GRASS full pull-out and over-extension technology with self-retraction and Air-matic soft-impact, proven in long-term tests
- smooth operation and lateral stability even under full load
- reinforced metal housing frame for container holder, powder-coated
- equipped with metal lid, powder-coated
- suitable for 16 mm and 19 mm side thicknesses
- available for five cupboard widths and in various heights
- installation depth amounts to 516 mm



### Cox Clan® convinces due to easy assembly:

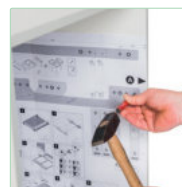

1. Transfer the mounting points in the body using the template.



2. Mount the pull-out rails and locating pins for the depositing lid.



3. Place the depositing lid on the pins and hook the pull-out frame into the pull-out rails.



4. Mount the front attachment using the template.



5. Hang the front plate into the pull-out frame and fasten it, then clip on the plastic covers.



6. Insert containers. Finished!

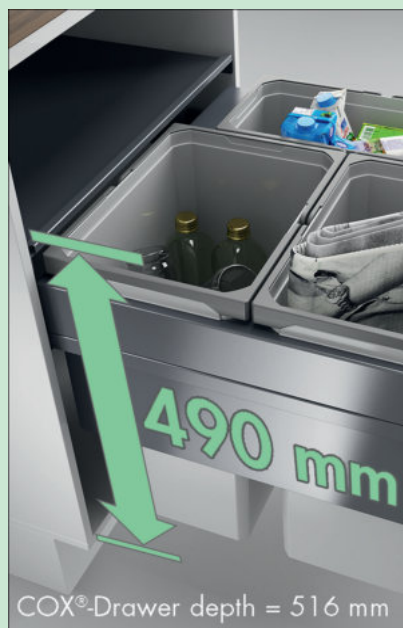

### Cox Clan® 490

Waste collector front pull-out system for large waste capacity with soft retraction and impact attenuation.

- installation height 490 mm
- installation depth 516 mm
- **depth of the installation frame 510 mm**
- "quick&easy" installation frame for different body thicknesses (16/19 mm)
- "nova Pro" guide rail
- functional design

Container fitting system/litres			
Cabinetbody	450	500	600
	29.5	29.5	29.5 21
	29.5	29.5	29.5

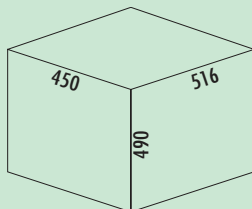

### Cox Clan® 490/450-2

- guide rail depth 510 mm
- waste capacity 59 (2 x 29.5) liters
- technology: over extension
- frame/guide silver
- complete lid silver
- fitting: cabinet wall and front panel
- **with soft retraction and damping**

8012381 light grey, H 490 mm

408.74 €

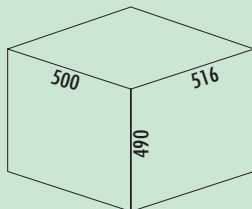

### Cox Clan® 490/500-2

- guide rail depth 510 mm
- waste capacity 59 (2 x 29.5) liters
- technology: over extension
- frame/guide silver
- complete lid silver
- fitting: cabinet wall and front panel
- **with soft retraction and damping**

8012382 light grey, H 490 mm

411.43 €

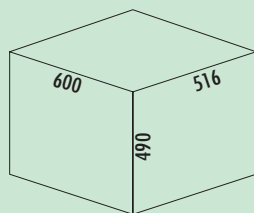

### Cox Clan® 490/600-3

- guide rail depth 510 mm
- waste capacity 80 (2 x 29.5/1 x 21) liters
- technology: over extension
- frame/guide silver
- complete lid silver
- fitting: cabinet wall and front panel
- **with soft retraction and damping**

8012384 light grey, H 490 mm

453.61 €

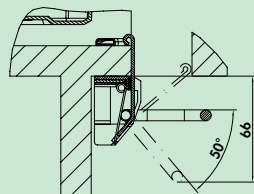

### Cox Cick®

Cox Cick® is a manual foot pedal that enables effortless access to the Cox® Base and Cox Clan® waste collectors. Thanks to the ergonomically pleasantly designed pedal position, the waste system opens completely with little force. After operation, the opening mechanism automatically returns to its original position with the aid of a spring. In this way, near-silent operation is guaranteed when opening and closing. The assembly is simple and quick due to two moulded lugs with position fixing. The necessary drilling points are easily found by means of a plastic assembly aid.

- bracket projection on 16 gauge front 34 mm
- bracket projection on 19 gauge front 31 mm

8012367 dark grey/chrome matt

66.47 €

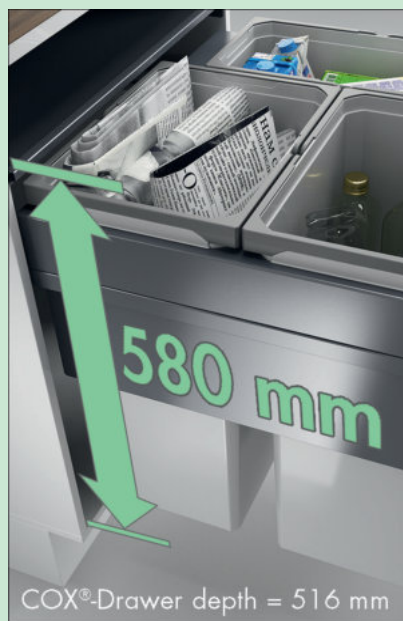

### Cox Clan® 580

Waste collector front pull-out system for large waste capacity with soft retraction and impact attenuation.

- installation height 580 mm
- installation depth 516 mm
- **depth of the installation frame 510 mm**
- "quick&easy" installation frame for different body thicknesses (16/19 mm)
- "nova Pro" guide rail
- functional design

Container fitting system / litres					
Cabinetbody	300	400	450	500	600
	1.2 32	1.2 35	35 35	35 35	35 35 21

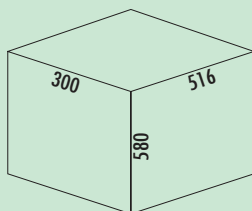
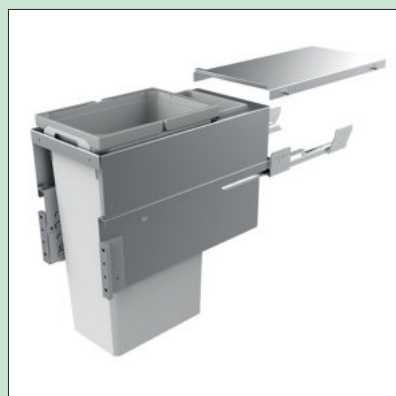

### Cox Clan® 580/300-2

- guide rail depth 510 mm
- waste capacity 33.2 (1 x 32/1 x 1.2) liters
- technology: full pull-out
- frame/guide silver
- complete lid silver
- fitting: cabinet wall and front panel
- **with soft retraction and damping**

8012386 light grey, H 580 mm

366.55 €

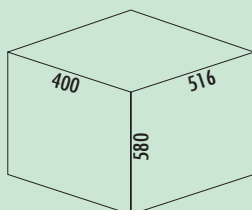

### Cox Clan® 580/400-2

- guide rail depth 510 mm
- waste capacity 36.2 (1 x 35/1 x 1.2) liters
- technology: full pull-out
- frame/guide silver
- complete lid silver
- fitting: cabinet wall and front panel
- **with soft retraction and damping**

8012387 light grey, H 580 mm

375.46 €

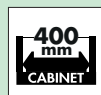

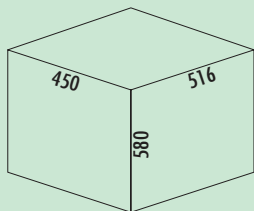

### Cox Clan® 580/450-2

- guide rail depth 510 mm
- waste capacity 70 (2 x 35) liters
- technology: over extension
- frame/guide silver
- complete lid silver
- fitting: cabinet wall and front panel
- **with soft retraction and damping**

8012388 light grey, H 580 mm

415.04 €

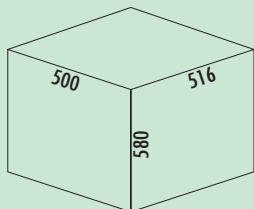

### Cox Clan® 580/500-2

- guide rail depth 510 mm
- waste capacity 70 (2 x 35) liters
- technology: over extension
- frame/guide silver
- complete lid silver
- fitting: cabinet wall and front panel
- **with soft retraction and damping**

8012389 light grey, H 580 mm

415.04 €

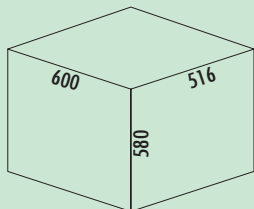

### Cox Clan® 580/600-3

- guide rail depth 510 mm
- waste capacity 91 (2 x 35/1 x 21) liters
- technology: over extension
- frame/guide silver
- complete lid silver
- fitting: cabinet wall and front panel
- **with soft retraction and damping**

8012391 light grey, H 580 mm

467.14 €











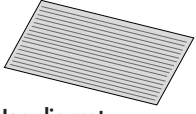



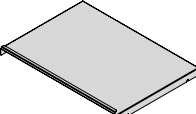





# Replacement bucket and lid overview for Cox® series

Width mm	102	113	183	183	204	230		
Depth mm	204	382	302	382	204	191		
	Order no.	€ per pc. excl. VAT	Order no.	€ per pc. excl. VAT	Order no.	€ per pc. excl. VAT	Order no.	€ per pc. excl. VAT
Height mm	82	 8013363* 8012363 11.51				 8013362* 8012362 13.87		
	144					 8013309* 8012309 19.83		
	216		 8013325* 8012325 25.55	 8013327* 8012327 30.42	 8013329* 8012329 32.77		 8013326* 8012326 26.89	
	256			 8012493 32.27	 8013492* 8012492 37.31		 8013491* 8012491 28.07	
	326	 8012332 31.60		 8013333* 8012333 37.56	 8013321* 8012321 40.25		 8013320* 8012320 32.86	
	426				 8013323* 8012323 44.79		 8013319 8012319 37.48	
	460							
	550							
Cealing lid			 8013339* 8012339 8.74	 8013341* 8012341 8.74		 8013338* 8012338 5.97		
Bill lid			 8013343* 8012343 16.39			 8013312* 8011312 14.79		

\*anthracite



# Replacement bucket and lid overview for Cox® series

Width mm	230	230	230	230	250	315	Accessories	
Depth mm	302	151	340	382	340	382		
	Order no. € per pc. excl. VTA	Order no. € per pc. excl. VTA	Order no. € per pc. excl. VTA	Order no. € per pc. excl. VTA	Order no. € per pc. excl. VTA	Order no. € per pc. excl. VTA	Order no. € per pc. excl. VAT	
Height mm	82						 <b>Non-slip mat</b> up to 600 mm 8013352* 11.93 8012352 11.93	
	144						up to 1200 mm 8013353* 23.70 8012353 23.70	
	216	 8012328 33.19			 8013330* 8012330 38.49	 8013331* 8012331 43.95	 <b>Complete lid</b> Width 400 mm 8013153* 8010153 79.75 Width 450 mm 8013154* 8010154 85.80	
	256	 8012494 37.31			 8013490* 8012490 40.84		Width 500 mm 8013145* 8010145 95.21 Width 600 mm 8013146* 8010146 98.82	
	326	 8013334* 8012334 39.66	 8013495* 8012495 29.58		 8013322* 8012322 46.55	 8013335* 8012335 49.75	Width 800 mm 8013356* 8012347 73.19 Width 900 mm 8013357* 8012348 78.49	
	426				 8013324* 8012324 48.99	 8013336* 8012336 57.73		
	460					 8012395 52.02		Width 1000 mm 8012349 85.46 Width 1200 mm 8012350 93.45
	550			 8012398 54.62		 8012397 56.39		Width 500 mm, Depth 320 mm 8013345* 8012345 93.45 Width 600 mm, Depth 320 mm 8013346* 8012346 95.21
	Sealing lid/ top frame	 8012340 9.41			 8013342* 8012342 9.41		 8012337 24.54	Width 600 mm, Depth 400 mm 8013351* 8012351 69.33
Bio lid	 8013344* 8012344 16.81	 8013497* 8012497 16.39					Width 300 mm, Depth 516 mm 8010160 74.20	

\*anthracite

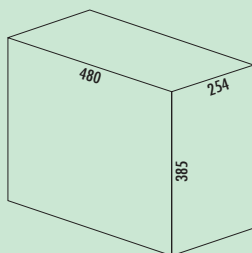

### Bio Double 30 BM

- waste capacity 30 (1 x 20/1 x 10) liters
- technology: full pull-out
- fitting: cabinet bottom and front panel

8012093 anthracite

183.28 €

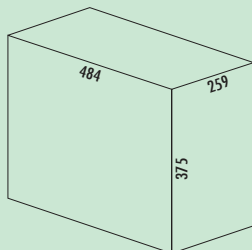

### Tandem 2

- waste capacity 30 (2 x 15) liters
- technology: for existing pull-outs
- fitting: on tray pull-out or in a drawer

8011053 graphite grey

138.32 €

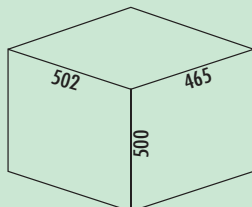

### Müllex Comfort 35/5/4/4

- low-noise, sturdy pull-out system
- waste capacity 48 (35/5/4/4) liters
- waste container 35 l with closing-lid as deposit for cleaning things
- for 35-l and 17-l bags
- bio-bucket 5 l with lid and carrying handle
- two 4-l containers with 2 lids and carrying handles
- technology: full pull-out
- pull-out shelves with positioning elements for the containers
- guide rail depth 530 mm
- lid black
- fitting: cabinet bottom and front panel
- max. cabinet width 600 mm

8011021 anthracite/green

478.99 €

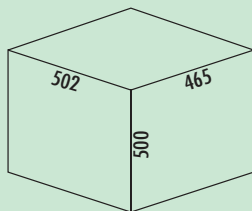

### Müllex Comfort 35/17/4/4

- low-noise, sturdy pull-out system
- waste capacity 60 (35/17/4/4) liters
- two waste containers for 35-l and 17-l bags
- two 4-l containers with lid and carrying handle
- closing-lid as deposit for cleaning things
- technology: full pull-out
- pull-out shelves with positioning elements for the containers
- guide rail depth 530 mm
- lid black
- fitting: cabinet bottom and front panel
- max. cabinet width 600 mm

8011054 black/light grey

478.99 €

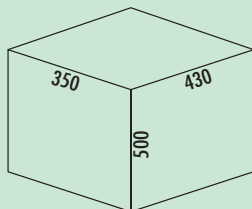

### Müllex Oekonom 35/2/2

- low-noise, sturdy pull-out system
- waste capacity 39 (35/2/2) liters
- waste container 35 l with flap for 35-l and 17-l bags
- two 2-l containers
- closing-lid as deposit for cleaning things
- in comparison to müllex comfort 30 mm shorter, allowing more space for sanitary installations
- technology: full pull-out
- pull-out shelves with positioning elements for the containers
- guide rail depth 500 mm
- lid black
- fitting: cabinet bottom and front panel
- max. cabinet width 600 mm

8011055 black

357.14 €

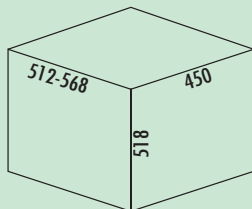

### Müllex Boxx 55/60-R Bio

- low-noise, sturdy pull-out system
- waste capacity 47 (41/5/1) liters
- container with round filling of the 35-l bin bag, extended with additional container and bio-bucket 5 l
- optional two 17-l bin bags
- technology: full pull-out
- pull-out cover drawer
- in case of bulky siphon, the rear wall of the drawer can be adjusted
- adapter for 600 mm body supplied
- retraction damping as standard
- guide rail depth 520 mm
- lid anthracite
- fitting: cabinet bottom and front panel
- max. cabinet width 600 mm

8011049 anthracite

537.82 €

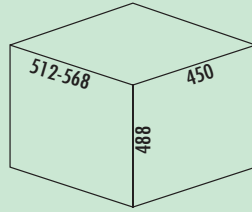

### Müllex Euro Boxx 55/60 R

- low-noise, sturdy pull-out system
- waste capacity 56 (1 x 40/1 x 16) liters
- container with round filling of the 35-l bin bag
- optional two 17-l bin bags
- technology: full pull-out
- pull-out cover drawer
- in case of bulky siphon, the rear wall of the drawer can be adjusted
- extended with 16-l additional container
- adapter for 600 mm body supplied
- retraction damping as standard
- guide rail depth 520 mm
- lid anthracite
- fitting: cabinet bottom and front panel
- max. cabinet width 600 mm

8011019 anthracite

508.40 €

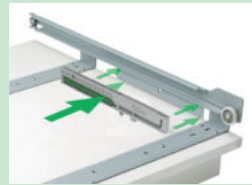
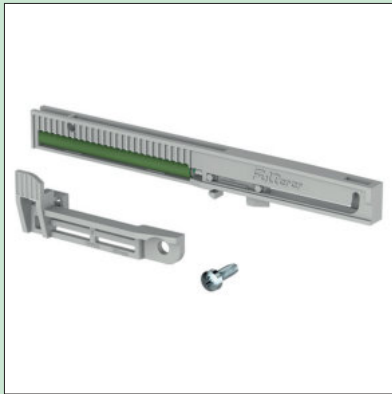

### StopMatic

The pull-out systems Müllex Comfort and Müllex Oekonom can be optionally equipped with the StopMatic accessories. A damper with "self-closing function" which can be inserted into the rail profile slows the pull-out just before it reaches the final position.

**StopMatic and KickMatic are not combinable.**

8011066 light grey

37.39 €



### KickMatic

The pull-out systems Müllex Comfort, Müllex Oekonom and Müllex Boxx can be equipped with the KickMatic accessories on request. Press lightly with your foot and the bucket slides gently out of the bottom cabinet. So you have both hands free.

**StopMatic and KickMatic are not combinable.**

8011070 chrome

122.69 €

# SELECTAkit®

## Pull-out technology for existing pull-outs

The flexible waste system



Cox Stand-UP® 250 S	Page 172-175
Cox Stand-UP® 280 S	Page 176-178
Cox Stand-UP® 350 S	Page 179-181
Cox Stand-UP® 350 K	Page 182-183
Cox® Box 235 S	Page 184-187
Cox® Box 235 K	Page 188-190
Cox® Box 275 S	Page 191-192
Cox® Box 275 K	Page 193-195
Cox® Box 360 S	Page 196-198
Cox® Box 350 S	Page 199-200
Cox® Giallo	Page 201
X-LINE	Page 202-203

Suitable for the following  
front layouts:



Full front    Front panel  
with one  
division    Front panel  
with one  
division    Front panel  
with two  
divisions

Please check the heights of the product groups.

# SELECTAkit®

## Pull-out technology for existing pull-outs



### Cox Stand-UP®

Kitchen base cabinets with front pull-out are available in several widths and various frame and front heights for kitchen planning. Naber provides waste collector combinations that make perfect use of the storage space in a comparable range of sizes.

- The waste system Cox Stand-UP® offers three container heights and can be configured for four different cabinet widths.
- Cox Stand-UP® is quick and easy to install; existing front pull-outs can also be equipped without any problems.

To provide kitchen users with the largest possible container volume, Cox Stand-UP® is highly flexible in design and adapts to any cabinet situation with or without a water connection.

- The complete lid of the system can also be installed behind the top front to save space and thus maximise the total possible volume.
- Note: 350 mm high waste collectors can be safely accommodated behind a 390 mm high cabinet front.

The high-quality containers are securely positioned in a floor-mounted frame. As optional accessories, sealing lids – also in the version for organic waste – make domestic waste and recycling management even easier.



Cox Stand-UP® 250 S



Cox Stand-UP® 280 S



Cox Stand-UP® 350 S



Cox Stand-UP® 350 K



### Cox Stand-UP® 250 S

The Cox-Stand-UP® waste system 250 is ideally suited for quick installation on existing pull-outs with a **nominal depth of 450 mm and 500 mm**. The total height of the system is 250 mm, whereby the **clear installation height is only 240 mm**. Depending on the installation situation, the fixed complete lid can also be mounted behind the upper front to save space. The maximum frame height (dimension from the pull-out shelf to the top edge of the frame) is 145 mm. The Cox-Stand-UP® waste system is available in different heights, cabinet widths and bucket combinations.

Container fitting system/litres			
Cabinet body	600	800	900
	13 13	13 10 13	13 13 13
	13 6 6	13 10 6 6	13 13 6 6

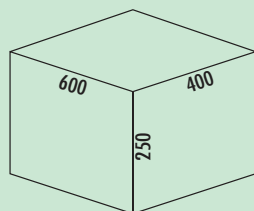

### Cox Stand-UP® 250 S/600-2

For mounting on existing pull-outs with a nominal depth of 450 mm and 500 mm.

- maximum frame height (dimension from the bottom of the drawer to the top edge of the frame) 145 mm
- minimum installation depth (internal dimension of the drawer) 400 mm
- waste volume 26(2 x 13) litres
- total height 250 mm
- installation height without complete lid 240 mm
- complete lid can be mounted behind the upper front to save space
- bucket height 216 mm
- **suitable for Cox Work® utensils box (see catalogue 1 pages 154–156/24 EN)**

**8013380** anthracite, H 250 mm **192.27 €**

#### Optional accessories

**8013342** Closing-lid, anthracite, for 13/ 16/ 22/ 28 liters **9.41 €**

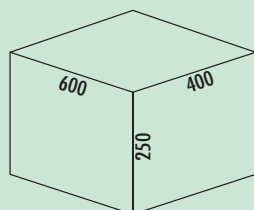

### Cox Stand-UP® 250 S/600-3

For mounting on existing pull-outs with a nominal depth of 450 mm and 500 mm.

- maximum frame height (dimension from the bottom of the drawer to the top edge of the frame) 145 mm
- minimum installation depth (internal dimension of the drawer) 400 mm
- waste volume 25(1 X 13/ 2 x 6) litres
- total height 250 mm
- installation height without complete lid 240 mm
- complete lid can be mounted behind the upper front to save space
- bucket height 216 mm
- **suitable for Cox Work® utensils box (see catalogue 1 pages 154–156/24 EN)**

**8013381** without bio lid, anthracite, H 250 mm **209.33 €**

**8013382** with bio lid, anthracite, H 250 mm **221.32 €**

#### Optional accessories

**8013312** Bio-lid, anthracite, for 4/ 6/ 7/ 10/ 12.5 liters **14.79 €**

**8011178** Bio-filter retrofitting set, black **7.39 €**

**8013342** Closing-lid, anthracite, for 13/ 16/ 22/ 28 liters **9.41 €**

**8013338** Closing-lid, anthracite, for 4/ 6/ 7/ 10/ 12.5 liters **5.97 €**

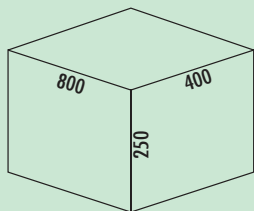

### Cox Stand-UP® 250 S/800-3

For mounting on existing pull-outs with a nominal depth of 450 mm and 500 mm.

- maximum frame height (dimension from the bottom of the drawer to the top edge of the frame) 145 mm
- minimum installation depth (internal dimension of the drawer) 400 mm
- waste volume 36(1 X 10/ 2 x 13) litres
- total height 250 mm
- installation height without complete lid 240 mm
- complete lid can be mounted behind the upper front to save space
- bucket height 216 mm
- suitable for Cox Work® utensils box (see catalogue 1 pages 154–156/24 EN)

8013383 anthracite, H 250 mm **281.18 €**

#### Optional accessories

8013342 Closing-lid, anthracite, for 13/ 16/ 22/ 28 liters **9.41 €**

8013341 Closing-lid, anthracite, for 10/ 12/ 16/ 21 liters **8.74 €**

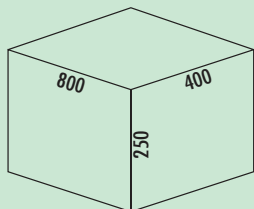

### Cox Stand-UP® 250 S/800-4

For mounting on existing pull-outs with a nominal depth of 450 mm and 500 mm.

- maximum frame height (dimension from the bottom of the drawer to the top edge of the frame) 145 mm
- minimum installation depth (internal dimension of the drawer) 400 mm
- waste volume 35 (1 x 13/1 x 10/2 x 6) litres
- total height 250 mm
- installation height without complete lid 240 mm
- complete lid can be mounted behind the upper front to save space
- bucket height 216 mm
- suitable for Cox Work® utensils box (see catalogue 1 pages 154–156/24 EN)

8013384 without bio lid, anthracite, H 250 mm **298.24 €**

8013385 with bio lid, anthracite, H 250 mm **310.68 €**

#### Optional accessories

8013312 Bio-lid, anthracite, for 4/ 6/ 7/ 10/ 12.5 liters **14.79 €**

8011178 Bio-filter retrofitting set, black **7.39 €**

8013342 Closing-lid, anthracite, for 13/ 16/ 22/ 28 liters **9.41 €**

8013341 Closing-lid, anthracite, for 10/ 12/ 16/ 21 liters **8.74 €**

8013338 Closing-lid, anthracite, for 4/ 6/ 7/ 10/ 12.5 liters **5.97 €**

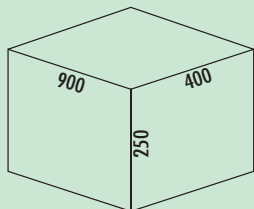

### Cox Stand-UP® 250 S/900-3

For mounting on existing pull-outs with a nominal depth of 450 mm and 500 mm.

- maximum frame height (dimension from the bottom of the drawer to the top edge of the frame) 145 mm
- minimum installation depth (internal dimension of the drawer) 400 mm
- waste volume 39(3 X 13) litres
- total height 250 mm
- installation height without complete lid 240 mm
- complete lid can be mounted behind the upper front to save space
- bucket height 216 mm
- suitable for Cox Work® utensils box (see catalogue 1 pages 154–156/24 EN)

8013386 anthracite, H 250 mm **298.24 €**

#### Optional accessories

8013342 Closing-lid, anthracite, for 13/ 16/ 22/ 28 liters **9.41 €**



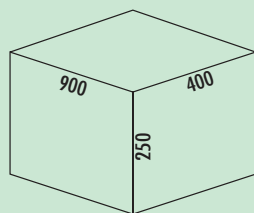

### Cox Stand-UP® 250 S/900-4

For mounting on existing pull-outs with a nominal depth of 450 mm and 500 mm.

- maximum frame height (dimension from the bottom of the drawer to the top edge of the frame) 145 mm
- minimum installation depth (internal dimension of the drawer) 400 mm
- waste volume 38 (2 X 13/ 2 x 6) litres
- total height 250 mm
- installation height without complete lid 240 mm
- complete lid can be mounted behind the upper front to save space
- bucket height 216 mm
- suitable for Cox Work® utensils box (see catalogue 1 pages 154–156/24 EN)

**8013387** without bio lid, anthracite, H 250 mm **316.22 €**

**8013388** with bio lid, anthracite, H 250 mm **328.53 €**

#### Optional accessories

**8013312** Bio-lid, anthracite, for 4/ 6/ 7/ 10/ 12.5 liters **14.79 €**

**8011178** Bio-filter retrofitting set, black **7.39 €**

**8013342** Closing-lid, anthracite, for 13/ 16/ 22/ 28 liters **9.41 €**

**8013338** Closing-lid, anthracite, for 4/ 6/ 7/ 10/ 12.5 liters **5.97 €**



### Cox Stand-UP® 280 S

The Cox-Stand-UP waste system 280 is ideally suited for quick installation on existing pull-outs with a **nominal depth of 450 mm and 500 mm**. The total height of the system is 280 mm, whereby the **clear installation height is only 270 mm**. Depending on the installation situation, the fixed complete lid can also be mounted behind the upper front to save space. The maximum frame height (dimension from the pull-out shelf to the top edge of the frame) is 175 mm. The Cox-Stand-UP waste system is available in different heights, cabinet widths and bucket combinations.

Container fitting system/litres			
Cabinet body	600	800	900
	16 16	16 12 16	16 16 16
	16 7 7	16 12 7 7	16 16 7 7

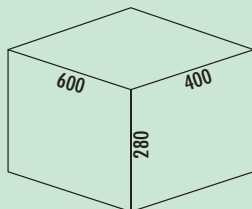

### Cox Stand-UP® 280 S/600-2

For mounting on existing pull-outs with a nominal depth of 450 mm and 500 mm.

- maximum frame height (dimension from the bottom of the drawer to the top edge of the frame) 175 mm
- minimum installation depth (internal dimension of the drawer) 400 mm
- waste volume 32 (2 X 16) litres
- total height 280 mm
- installation height without complete lid 270 mm
- complete lid can be mounted behind the upper front to save space
- bucket height 256 mm
- **suitable for Cox Work® utensils box (see catalogue 1 pages 154–156/24 EN)**

**8013389** anthracite, H 280 mm **199.41 €**

#### Optional accessories

**8013342** Closing-lid, anthracite, for 13/ 16/ 22/ 28 liters **9.41 €**

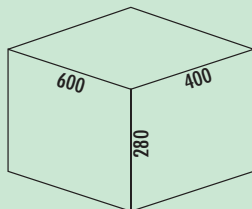

### Cox Stand-UP® 280 S/600-3

For mounting on existing pull-outs with a nominal depth of 450 mm and 500 mm.

- maximum frame height (dimension from the bottom of the drawer to the top edge of the frame) 175 mm
- minimum installation depth (internal dimension of the drawer) 400 mm
- waste volume 30(1 X 16/ 2 x 7) litres
- total height 280 mm
- installation height without complete lid 270 mm
- complete lid can be mounted behind the upper front to save space
- bucket height 256 mm
- **suitable for Cox Work® utensils box (see catalogue 1 pages 154–156/24 EN)**

**8013390** without bio lid, anthracite, H 280 mm **212.94 €**

**8013391** with bio lid, anthracite, H 280 mm **224.88 €**

#### Optional accessories

**8013312** Bio-lid, anthracite, for 4/ 6/ 7/ 10/ 12.5 liters **14.79 €**

**8011178** Bio-filter retrofitting set, black **7.39 €**

**8013342** Closing-lid, anthracite, for 13/ 16/ 22/ 28 liters **9.41 €**

**8013338** Closing-lid, anthracite, for 4/ 6/ 7/ 10/ 12.5 liters **5.97 €**

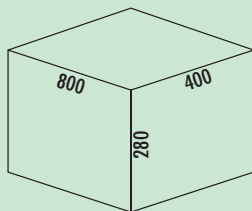

### Cox Stand-UP® 280 S/800-3

For mounting on existing pull-outs with a nominal depth of 450 mm and 500 mm.

- maximum frame height (dimension from the bottom of the drawer to the top edge of the frame) 175 mm
- minimum installation depth (internal dimension of the drawer) 400 mm
- waste volume 44(2 X 16/ 1 x 12) litres
- total height 280 mm
- installation height without complete lid 270 mm
- complete lid can be mounted behind the upper front to save space
- bucket height 256 mm
- suitable for Cox Work® utensils box (see catalogue 1 pages 154–156/24 EN)

8013393 anthracite, H 280 mm 290.17 €

#### Optional accessories

8013342 Closing-lid, anthracite, for 13/ 16/ 22/ 28 liters 9.41 €

8013341 Closing-lid, anthracite, for 10/ 12/ 16/ 21 liters 8.74 €

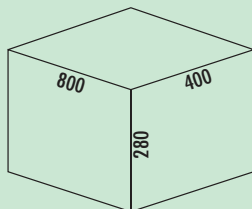

### Cox Stand-UP® 280 S/800-4

For mounting on existing pull-outs with a nominal depth of 450 mm and 500 mm.

- maximum frame height (dimension from the bottom of the drawer to the top edge of the frame) 175 mm
- minimum installation depth (internal dimension of the drawer) 400 mm
- waste volume 42 (1 x 16/1 x 12/2 x 7) litres
- total height 280 mm
- installation height without complete lid 270 mm
- complete lid can be mounted behind the upper front to save space
- bucket height 256 mm
- suitable for Cox Work® utensils box (see catalogue 1 pages 154–156/24 EN)

8013394 without bio lid, anthracite, H 280 mm 303.61 €

8013395 with bio lid, anthracite, H 280 mm 315.22 €

#### Optional accessories

8013312 Bio-lid, anthracite, for 4/ 6/ 7/ 10/ 12.5 liters 14.79 €

8011178 Bio-filter retrofitting set, black 7.39 €

8013342 Closing-lid, anthracite, for 13/ 16/ 22/ 28 liters 9.41 €

8013341 Closing-lid, anthracite, for 10/ 12/ 16/ 21 liters 8.74 €

8013338 Closing-lid, anthracite, for 4/ 6/ 7/ 10/ 12.5 liters 5.97 €

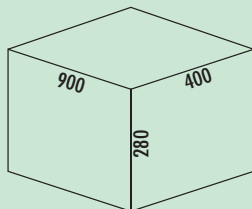

### Cox Stand-UP® 280 S/900-3

For mounting on existing pull-outs with a nominal depth of 450 mm and 500 mm.

- maximum frame height (dimension from the bottom of the drawer to the top edge of the frame) 175 mm
- minimum installation depth (internal dimension of the drawer) 400 mm
- waste volume 48 (3 x 16) litres
- total height 280 mm
- installation height without complete lid 270 mm
- complete lid can be mounted behind the upper front to save space
- bucket height 256 mm
- suitable for Cox Work® utensils box (see catalogue 1 pages 154–156/24 EN)

8013396 anthracite, H 280 mm 310.84 €

#### Optional accessories

8013342 Closing-lid, anthracite, for 13/ 16/ 22/ 28 liters 9.41 €

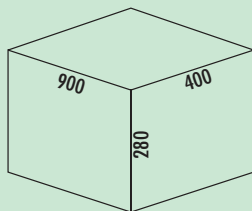

### Cox Stand-UP® 280 S/900-4

For mounting on existing pull-outs with a nominal depth of 450 mm and 500 mm.

- maximum frame height (dimension from the bottom of the drawer to the top edge of the frame) 175 mm
- minimum installation depth (internal dimension of the drawer) 400 mm
- waste volume 46 (2 x 16/ 2 x 7) litres
- total height 280 mm
- installation height without complete lid 270 mm
- complete lid can be mounted behind the upper front to save space
- bucket height 256 mm
- suitable for Cox Work® utensils box (see catalogue 1 pages 154–156/24 EN)

**8013397** without bio lid, anthracite, H 280 mm **323.36 €**

**8013398** with bio lid, anthracite, H 280 mm **334.77 €**

#### Optional accessories

**8013312** Bio-lid, anthracite, for 4/ 6/ 7/ 10/ 12.5 liters **14.79 €**

**8011178** Bio-filter retrofitting set, black **7.39 €**

**8013342** Closing-lid, anthracite, for 13/ 16/ 22/ 28 liters **9.41 €**

**8013338** Closing-lid, anthracite, for 4/ 6/ 7/ 10/ 12.5 liters **5.97 €**



### Cox Stand-UP® 350 S

The Cox-Stand-UP® waste system 350 is ideally suited for quick installation on existing pull-outs with a **nominal depth of 450 mm and 500 mm**. The total height of the system is 350 mm, whereby the **clear installation height is only 340 mm**. Depending on the installation situation, the fixed complete lid can also be mounted behind the upper front to save space. The maximum frame height (dimension from the pull-out shelf to the top edge of the frame) is 245 mm. The Cox-Stand-UP® waste system is available in different heights, cabinet widths and bucket combinations.

Container fitting system/litres				
Cabinet Body	500	500	600	600
	16 10 10	16 22	22 10 10	22 22
Cabinet Body	800		900	900
	22 16 10 10	22 22 10 10	22 22 22	

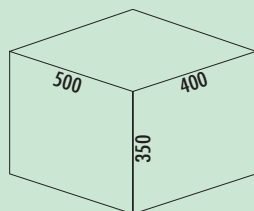

### Cox Stand-UP® 350 S/500-2

For mounting on existing pull-outs with a nominal depth of 450 mm and 500 mm.

- maximum frame height (dimension from the bottom of the drawer to the top edge of the frame) 245 mm
- minimum installation depth (internal dimension of the drawer) 400 mm
- waste volume 38 (1 x 16/1 x 22) litres
- total height 350 mm
- installation height without complete lid 340 mm
- complete lid can be mounted behind the upper front to save space
- bucket height 326 mm

**8013423** anthracite, H 350 mm **204.79 €**

#### Optional accessories

**8013342** Closing-lid, anthracite, for 13/ 16/ 22/ 28 liters **9.41 €**

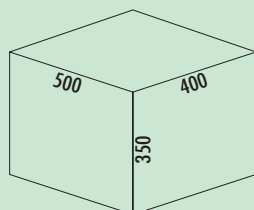

### Cox Stand-UP® 350 S/500-3

For mounting on existing pull-outs with a nominal depth of 450 mm and 500 mm.

- maximum frame height (dimension from the bottom of the drawer to the top edge of the frame) 245 mm
- minimum installation depth (internal dimension of the drawer) 400 mm
- waste volume 36 (2 x 10/1 x 16) litres
- total height 350 mm
- installation height without complete lid 340 mm
- complete lid can be mounted behind the upper front to save space
- bucket height 326 mm

**8013399** anthracite, H 350 mm **212.94 €**

#### Optional accessories

**8013338** Closing-lid, anthracite, for 4/ 6/ 7/ 10/ 12.5 liters **5.97 €**

**8013341** Closing-lid, anthracite, for 10/ 12/ 16/ 21 liters **8.74 €**

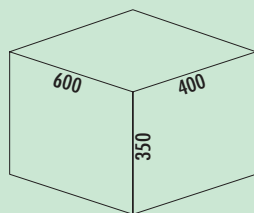

### Cox Stand-UP® 350 S/600-2

For mounting on existing pull-outs with a nominal depth of 450 mm and 500 mm.

- maximum frame height (dimension from the bottom of the drawer to the top edge of the frame) 245 mm
- minimum installation depth (internal dimension of the drawer) 400 mm
- waste volume 44 (2 x 22) litres
- total height 350 mm
- installation height without complete lid 340 mm
- complete lid can be mounted behind the upper front to save space
- bucket height 326 mm
- suitable for Cox Work® utensils box (see catalogue 1 page 154–156/24 EN)

8013424 209.30 €

#### Optional accessories

8013342 Closing-lid, anthracite, for 13/ 16/ 22/ 28 liters 9.41 €

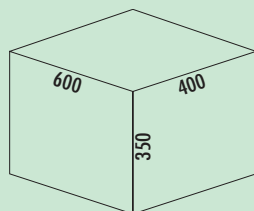

### Cox Stand-UP® 350 S/600-3

For mounting on existing pull-outs with a nominal depth of 450 mm and 500 mm.

- maximum frame height (dimension from the bottom of the drawer to the top edge of the frame) 245 mm
- minimum installation depth (internal dimension of the drawer) 400 mm
- waste volume 42 (2 x 10/1 x 22) litres
- total height 350 mm
- installation height without complete lid 340 mm
- complete lid can be mounted behind the upper front to save space
- bucket height 326 mm
- suitable for Cox Work® utensils box (see catalogue 1 pages 154–156/24 EN)

8013410 without bio lid, anthracite, H 350 mm 220.08 €

8013411 with bio lid, anthracite, H 350 mm 232.52 €

#### Optional accessories

8013312 Bio-lid, anthracite, for 4/ 6/ 7/ 10/ 12.5 liters 14.79 €

8011178 Bio-filter retrofitting set, black 7.39 €

8013338 Closing-lid, anthracite, for 4/ 6/ 7/ 10/ 12.5 liters 5.97 €

8013342 Closing-lid, anthracite, for 13/ 16/ 22/ 28 liters 9.41 €

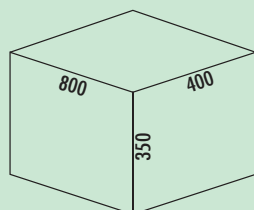

### Cox Stand-UP® 350 S/800-4

For mounting on existing pull-outs with a nominal depth of 450 mm and 500 mm.

- maximum frame height (dimension from the bottom of the drawer to the top edge of the frame) 245 mm
- minimum installation depth (internal dimension of the drawer) 400 mm
- waste volume 58 (2 x 10/1 x 22/1 x 16) litres
- total height 350 mm
- installation height without complete lid 340 mm
- complete lid can be mounted behind the upper front to save space
- bucket height 326 mm
- suitable for Cox Work® utensils box (see catalogue 1 pages 154–156/24 EN)

8013412 without bio lid, anthracite, H 350 mm 314.45 €

8013413 with bio lid, anthracite, H 350 mm 326.77 €

#### Optional accessories

8013312 Bio-lid, anthracite, for 4/ 6/ 7/ 10/ 12.5 liters 14.79 €

8011178 Bio-filter retrofitting set, black 7.39 €

8013338 Closing-lid, anthracite, for 4/ 6/ 7/ 10/ 12.5 liters 5.97 €

8013342 Closing-lid, anthracite, for 13/ 16/ 22/ 28 liters 9.41 €

8013341 Closing-lid, anthracite, for 10/ 12/ 16/ 21 liters 8.74 €

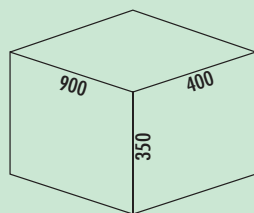

### Cox Stand-UP® 350 S/900-3

For mounting on existing pull-outs with a nominal depth of 450 mm and 500 mm.

- maximum frame height (dimension from the bottom of the drawer to the top edge of the frame) 245 mm
- minimum installation depth (internal dimension of the drawer) 400 mm
- waste volume 66 (3 x 22) litres
- total height 350 mm
- installation height without complete lid 340 mm
- complete lid can be mounted behind the upper front to save space
- bucket height 326 mm
- suitable for Cox Work® utensils box (see catalogue 1 pages 154–156/24 EN)

**8013414** without bio lid, anthracite, H 350 mm **323.36 €**

#### Optional accessories

**8013342** Closing-lid, anthracite, for 13/ 16/ 22/ 28 liters **9.41 €**

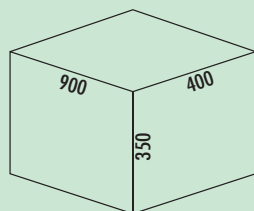

### Cox Stand-UP® 350 S/900-4

For mounting on existing pull-outs with a nominal depth of 450 mm and 500 mm.

- maximum frame height (dimension from the bottom of the drawer to the top edge of the frame) 245 mm
- minimum installation depth (internal dimension of the drawer) 400 mm
- waste volume 64 (2 x 22/2 x 10) litres
- total height 350 mm
- installation height without complete lid 340 mm
- complete lid can be mounted behind the upper front to save space
- bucket height 326 mm
- suitable for Cox Work® utensils box (see catalogue 1 pages 154–156/24 EN)

**8013415** without bio lid, anthracite, H 350 mm **335.04 €**

**8013416** with bio lid, anthracite, H 350 mm **347.21 €**

#### Optional accessories

**8013312** Bio-lid, anthracite, for 4/ 6/ 7/ 10/ 12.5 liters **14.79 €**

**8011178** Bio-filter retrofitting set, black **7.39 €**

**8013342** Closing-lid, anthracite, for 13/ 16/ 22/ 28 liters **9.41 €**

**8013338** Closing-lid, anthracite, for 4/ 6/ 7/ 10/ 12.5 liters **5.97 €**



### Cox Stand-UP® 350 K

The Cox-Stand-UP® waste system 350 is ideally suited for quick installation on existing pull-outs with a **nominal depth of 400 mm**. The total height of the system is 350 mm, whereby the **clear installation height is only 340 mm**. Depending on the installation situation, the fixed complete lid can also be mounted behind the upper front to save space. The maximum frame height (dimension from the pull-out shelf to the top edge of the frame) is 245 mm. The Cox-Stand-UP® waste system is available in different heights, cabinet widths and bucket combinations.

Container fitting system/litres		
Cabinet Body	500K	600K
	12 7,5 7,5	15,5 7,5 7,5

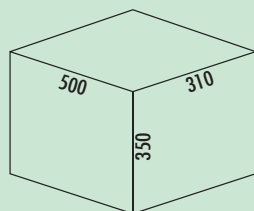

### Cox Stand-UP® 350 K/500-3

**For mounting on existing pull-outs with a shortened nominal depth of 400 mm.**

- maximum frame height (dimension from the bottom of the drawer to the top edge of the frame) 245 mm
- minimum installation depth (internal dimension of the drawer) 310 mm
- waste volume 27 (2 X 7.5/ 1 x 12) litres
- total height 350 mm
- installation height without complete lid 340 mm
- installation depth of the complete lid 400mm
- complete lid can be mounted behind the upper front to save space
- bucket height 326 mm

**8013404** anthracite, H 350 mm **224.54 €**

#### Optional accessories

**8013497** Bio lid, anthracite, for 7.5 liters **16.39 €**

**8013339** Closing-lid, anthracite, for 7.5/ 9/ 12 liters **8.74 €**

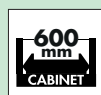
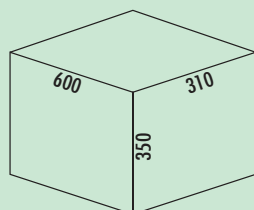

### Cox Stand-UP® 350 K/600-3

**For mounting on existing pull-outs with a shortened nominal depth of 400 mm.**

The 600 mm-wide Cox®-Stand-UP® waste system is supplied with a matching fixed complete lid for the cabinet. This creates additional practical storage space alongside the waste system in the pull-out.

- maximum frame height (dimension from the bottom of the drawer to the top edge of the frame) 245 mm
- minimum installation depth (internal dimension of the drawer) 310 mm
- waste volume 30.5 (2 x 7.5/1 x 15.5) litres
- total height 350 mm
- installation height without complete lid 340 mm
- installation depth of the complete lid 400 mm
- complete lid can be mounted behind the upper front to save space
- bucket height 326 mm

**8013420** anthracite, H 350 mm **262.04 €**

#### Optional accessories

**8013497** Bio lid, anthracite, for 7.5 liters **16.39 €**

**8013344** Bio lid, anthracite, for 10/ 12/ 15.5 liters **16.81 €**



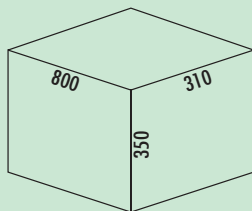

### Cox Stand-UP® 350 K/800-3

**For mounting on existing pull-outs with a shortened nominal depth of 400 mm.** The 800 mm-wide Cox®-Stand-UP® waste system is supplied with a matching fixed complete lid for the cabinet. This creates additional practical storage space alongside the waste system in the pull-out.

- maximum frame height (dimension from the bottom of the drawer to the top edge of the frame) 245 mm
- minimum installation depth (internal dimension of the drawer) 310 mm
- waste volume 30.5 (2 x 7.5/1 x 15.5) litres
- total height 350 mm
- installation height without complete lid 340 mm
- installation depth of the complete lid 400 mm
- complete lid can be mounted behind the upper front to save space
- bucket height 326 mm

<b>8013421</b> anthracite, H 350 mm	<b>265.22 €</b>
-------------------------------------	-----------------

#### Optional accessories

<b>8013497</b> Bio lid, anthracite, for 7.5 liters	<b>16.39 €</b>
<b>8013344</b> Bio lid, anthracite, for 10/ 12/ 15.5 liters	<b>16.81 €</b>

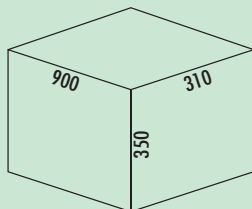

### Cox Stand-UP® 350 K/900-3

**For mounting on existing pull-outs with a shortened nominal depth of 400 mm.** The 900 mm-wide Cox®-Stand-UP® waste system is supplied with a matching fixed complete lid for the cabinet. This creates additional practical storage space alongside the waste system in the pull-out.

- maximum frame height (dimension from the bottom of the drawer to the top edge of the frame) 245 mm
- minimum installation depth (internal dimension of the drawer) 310 mm
- waste volume 30.5 (2 x 7.5/1 x 15.5) litres
- total height 350 mm
- installation height without complete lid 340 mm
- installation depth of the complete lid 400 mm
- complete lid can be mounted behind the upper front to save space
- bucket height 326 mm

<b>8013422</b> anthracite, H 350 mm	<b>271.16 €</b>
-------------------------------------	-----------------

#### Optional accessories

<b>8013497</b> Bio lid, anthracite, for 7.5 liters	<b>16.39 €</b>
<b>8013344</b> Bio lid, anthracite, for 10/ 12/ 15.5 liters	<b>16.81 €</b>

# SELECTAkit®

## Pull-out technology for existing pull-outs

### Cox® Box 235/275

Cox® Box 235 S is the sophisticated individual built-in waste collector solution for existing pull-out technology.

- suitable for existing pull-outs from all manufacturers
- individual container-configuration for many applications
- easy installation due to cut-to-size anti-slip mat under the containers
- continuous fixed metal lid over all the containers, powder-coated
- available for eight cabinet widths and for low container height 216/256 mm, installation height with metal lid 235/275 mm
- optional single closing lid or bio lid with activated carbon filter



### The Cox® Box convinces due to easy assembly:



1. Measure the bottom of the pull-out and cut anti-slip insert mat to size.



2. Insert anti-slip insert mat.



3. Place the container in the pull-out.

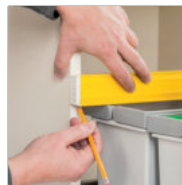

4. Measure the container height and transfer to body.

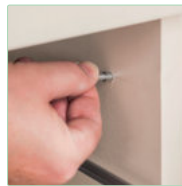

5. Drill and insert the lid locating pins into the side of the body.

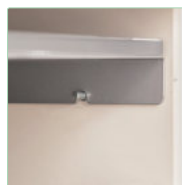

6. Mount the depositing lid on the locating pins. Finished!



### Cox® Box 235 S

The Cox® Box waste collection system is ideally suited for a multi-part front.

- with fixed silver-coloured metal lid
- with non-slip mat, TPE-coated on both sides
- for installation on existing pull-outs
- **the height of the entire system is only 235 mm**
- **The total lid can be mounted behind the top front to save space.**

Container fitting system/litres			
Cabinet body	1000	1000	1200
	13 10 10 13	6 10 10 13 6	6 10 13 10 13 6
<b>Bio</b>	10 10 10 13	6 10 10 13 6	6 10 13 10 13 6

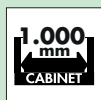
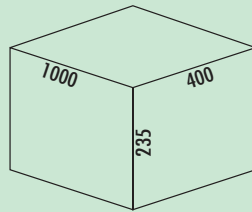

### Cox® Box 235 S/1000-4

For installation on existing pull-outs. With non-slip inlay mat and fixed complete lid.

- waste capacity 46 (2 x 13/2 x 10) liters
- bucket height 216 mm
- **total height 235 mm**
- **The complete lid can be mounted behind the top front to save space.**
- **suitable for Cox Work® utensils box (see catalogue 1 pages 154–156/24 EN)**

8012440 light grey 260.49 €

#### Optional accessories

8012342 Closing-lid, light grey, for 13/ 16/ 22/ 28 liters 9.41 €

8012341 Closing-lid, light grey, for 10/ 12/ 16/ 21 liters 8.74 €

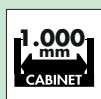
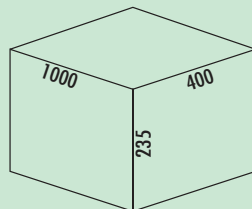
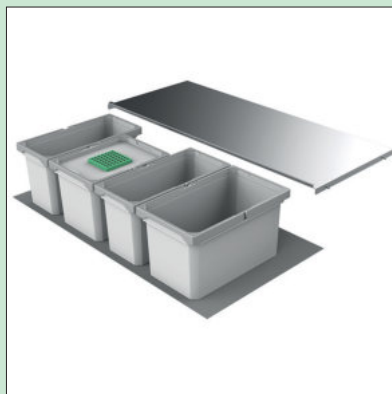

### Cox® Box 235 S/1000-4 Bio

For installation on existing pull-outs. With non-slip inlay mat, fixed complete lid and single bio-lid.

- waste capacity 43 (1 x 13/2 x 10/1 x 10) liters
- bucket height 216 mm
- **total height 235 mm**
- **The complete lid can be mounted behind the top front to save space.**
- **suitable for Cox Work® utensils box (see catalogue 1 pages 154–156/24 EN)**

8012448 light grey 273.95 €

#### Optional accessories

8012342 Closing-lid, light grey, for 13/ 16/ 22/ 28 liters 9.41 €

8012341 Closing-lid, light grey, for 10/ 12/ 16/ 21 liters 8.74 €

8012340 Closing-lid, light grey, for 10/ 12/ 15.5 liters 9.41 €

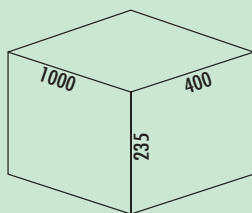

### Cox® Box 235 S/1000-5

For installation on existing pull-outs. With non-slip inlay mat and fixed complete lid.

- waste capacity 45 (1 x 13/2 x 10/2 x 6) liters
- bucket height 216 mm
- **total height 235 mm**
- **The total lid can be mounted behind the top front to save space.**
- suitable for Cox Work® utensils box (see catalogue 1 pages 154–156/24 EN)

8012438 light grey 262.97 €

#### Optional accessories

8012342 Closing-lid, light grey, for 13/ 16/ 22/ 28 liters 9.41 €

8012341 Closing-lid, light grey, for 10/ 12/ 16/ 21 liters 8.74 €

8012338 Closing-lid, light grey, for 4/ 6/ 7/ 10/ 12.5 liters 5.97 €

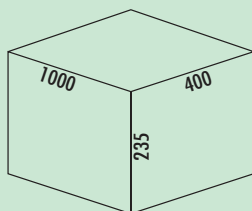
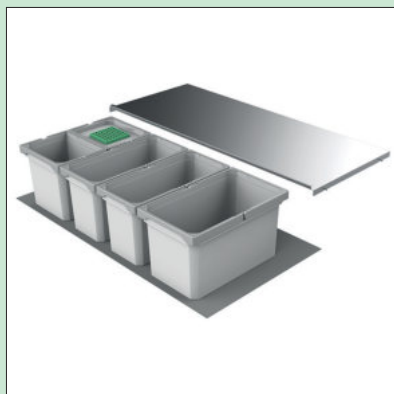

### Cox® Box 235 S/1000-5 Bio

For installation on existing pull-outs. With non-slip inlay mat, fixed complete lid and single bio-lid.

- waste capacity 45 (1 x 13/2 x 10/2 x 6) liters
- bucket height 216 mm
- **total height 235 mm**
- **The complete lid can be mounted behind the top front to save space.**
- suitable for Cox Work® utensils box (see catalogue 1 pages 154–156/24 EN)

8012439 light grey 276.83 €

#### Optional accessories

8012342 Closing-lid, light grey, for 13/ 16/ 22/ 28 liters 9.41 €

8012341 Closing-lid, light grey, for 10/ 12/ 16/ 21 liters 8.74 €

8012338 Closing-lid, light grey, for 4/ 6/ 7/ 10/ 12.5 liters 5.97 €

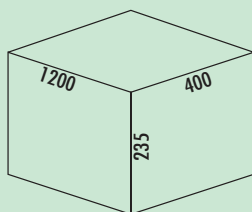
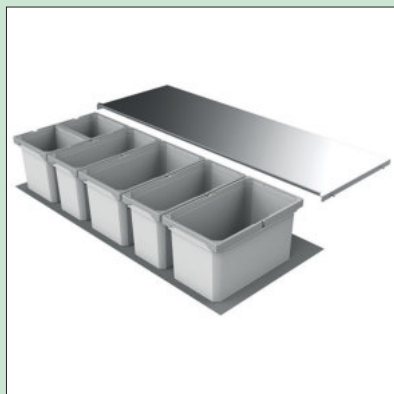

### Cox® Box 235 S/1200-6

For installation on existing pull-outs. With non-slip inlay mat and fixed complete lid.

- waste capacity 58 (2 x 13/2 x 10/2 x 6) liters
- bucket height 216 mm
- **total height 235 mm**
- **The complete lid can be mounted behind the top front to save space.**
- suitable for Cox Work® utensils box (see catalogue 1 pages 154–156/24 EN)

8012441 light grey 304.05 €

#### Optional accessories

8012342 Closing-lid, light grey, for 13/ 16/ 22/ 28 liters 9.41 €

8012341 Closing-lid, light grey, for 10/ 12/ 16/ 21 liters 8.74 €

8012338 Closing-lid, light grey, for 4/ 6/ 7/ 10/ 12.5 liters 5.97 €

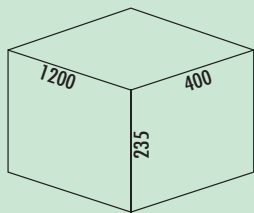

### Cox® Box 235 S/1200-6 Bio

For installation on existing pull-outs. With non-slip inlay mat, fixed complete lid and single bio-lid.

- waste capacity 58 (2 x 13/2 x 10/2 x 6) liters
- bucket height 216 mm
- **total height 235 mm**
- **The complete lid can be mounted behind the top front to save space.**
- suitable for Cox Work® utensils box (see catalogue 1 pages 154–156/24 EN)

8012442 light grey	314.29 €
--------------------	----------

#### Optional accessories

8012342 Closing-lid, light grey, for 13/ 16/ 22/ 28 liters	9.41 €
--	--------

8012341 Closing-lid, light grey, for 10/ 12/ 16/ 21 liters	8.74 €
--	--------

8012338 Closing-lid, light grey, for 4/ 6/ 7/ 10/ 12.5 liters	5.97 €
---	--------

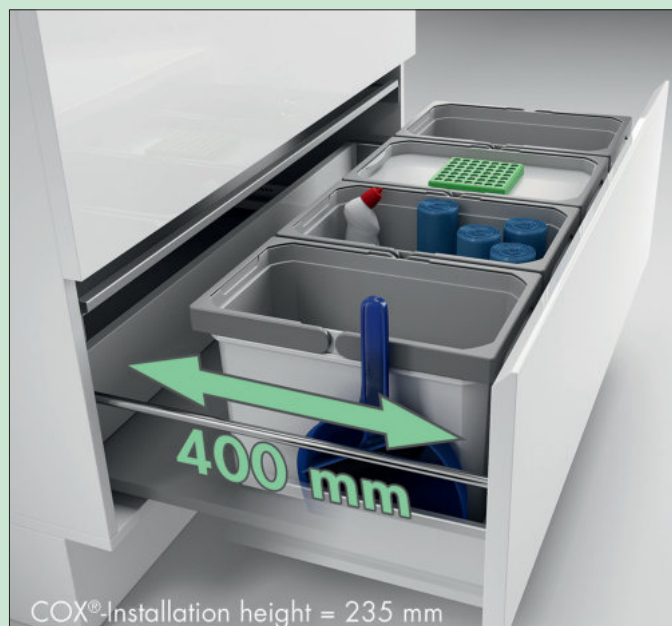

## Cox® Box 235 K

The Cox® Box waste collection system is ideally suited for a multi-part front.

- with fixed silver-coloured metal lid
- with non-slip mat, TPE-coated on both sides
- for installation on existing pull-outs
- **the height of the entire system is only 235 mm**
- **The total lid can be mounted behind the top front to save space.**
- **for drawers with a depth of 400 mm**

Container fitting system/litres				
Cabinet body	600	800	900	900
	10 10	10 10 10	10 10 10	7.5 7.5 7.5 7.5
Cabinet body	1000		1200	
	10 7.5 7.5 10	10 7.5 10 7.5 10		

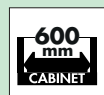
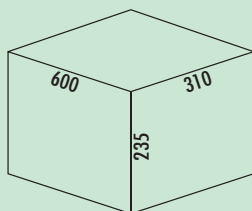

## Cox® Box 235 K/600-2

For installation on existing pull-outs. With non-slip inlay mat and fixed complete lid.

- waste capacity 20 (2 x 10) liters
- bucket height 216 mm
- **total height 235 mm**
- **The total lid can be mounted behind the top front to save space.**

**8012450** without bio lid, light grey **142.86 €**

**8012451** with bio lid, light grey **150.89 €**

### Optional accessories

**8012340** Closing-lid, light grey, for 10/ 12/ 15.5 liters **9.41 €**

**8012344** Bio-lid, light grey, for 10/ 12/ 15.5 liters **16.81 €**

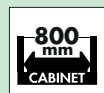
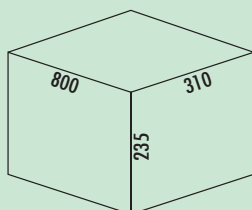
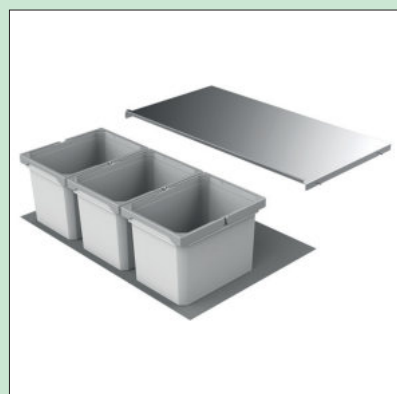

## Cox® Box 235 K/800-3

For installation on existing pull-outs. With non-slip inlay mat and fixed complete lid.

- waste capacity 30 (3 x 10) liters
- bucket height 216 mm
- **total height 235 mm**
- **The complete lid can be mounted behind the top front to save space.**

**8012452** without bio lid, light grey **192.27 €**

**8012453** with bio lid, light grey **199.67 €**

### Optional accessories

**8012340** Closing-lid, light grey, for 10/ 12/ 15.5 liters **9.41 €**

**8012344** Bio-lid, light grey, for 10/ 12/ 15.5 liters **16.81 €**

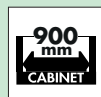
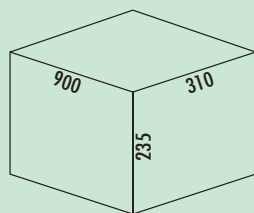
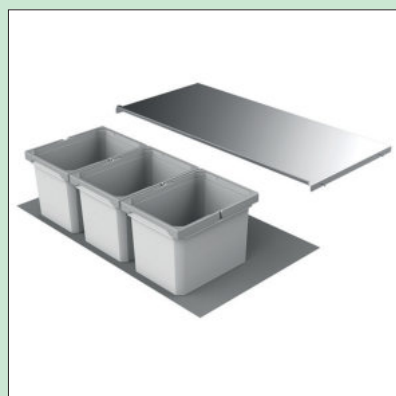

### Cox® Box 235 K/900-3

For installation on existing pull-outs. With non-slip inlay mat and fixed complete lid.

- waste capacity 30 (3 x 10) liters
- bucket height 216 mm
- **total height 235 mm**
- **The complete lid can be mounted behind the top front to save space.**

8012454 without bio lid, light grey **184.61 €**

8012455 with bio lid, light grey **205.46 €**

#### Optional accessories

8012344 Bio-lid, light grey, for 10/ 12/ 15.5 liters **16.81 €**

8012340 Closing-lid, light grey, for 10/ 12/ 15.5 liters **9.41 €**

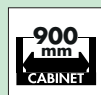
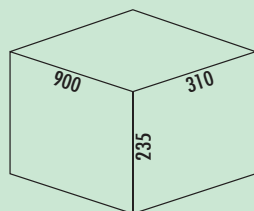
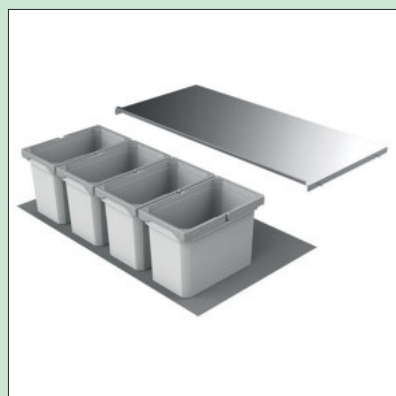

### Cox® Box 235 K/900-4

For installation on existing pull-outs. With non-slip inlay mat and fixed complete lid.

- waste capacity 30 (4 x 7.5) liters
- bucket height 216 mm
- **total height 235 mm**
- **The complete lid can be mounted behind the top front to save space.**

8012456 without bio lid, light grey **209.32 €**

8012457 with bio lid, light grey **224.04 €**

#### Optional accessories

8012339 Closing-lid, light grey, for 7.5/ 9/ 12 liters **8.74 €**

8012343 Bio-lid, light grey, for 7.5/ 9/ 12 liters **16.39 €**

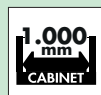
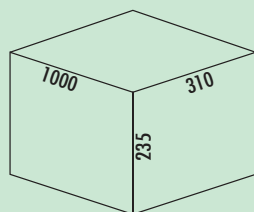
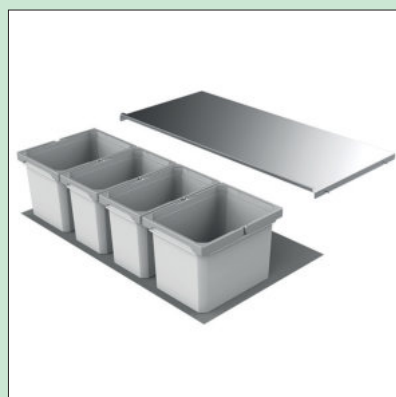

### Cox® Box 235 K/1000-4

For installation on existing pull-outs. With non-slip inlay mat and fixed complete lid.

- waste capacity 35 (2 x 10/2 x 7.5) liters
- bucket height 216 mm
- **total height 235 mm**
- **The complete lid can be mounted behind the top front to save space.**

8012458 without bio lid, light grey **220.42 €**

8012459 with bio lid, light grey **233.18 €**

#### Optional accessories

8012339 Closing-lid, light grey, for 7.5/ 9/ 12 liters **8.74 €**

8012340 Closing-lid, light grey, for 10/ 12/ 15.5 liters **9.41 €**

8012343 Bio-lid, light grey, for 7.5/ 9/ 12 liters **16.39 €**

8012344 Bio-lid, light grey, for 10/ 12/ 15.5 liters **16.81 €**

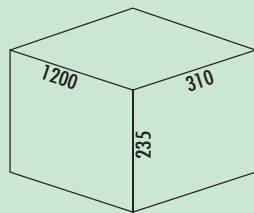

**Cox® Box 235 K/1200-5**

For installation on existing pull-outs. With non-slip inlay mat and fixed complete lid.

- waste capacity 45 (3 x 10/2 x 7.5) liters
- bucket height 216 mm
- **total height 235 mm**
- **The complete lid can be mounted behind the top front to save space.**

**8012460** without bio lid, light grey **255.36 €**

**8012461** with bio lid, light grey **273.37 €**

**Optional accessories**

**8012339** Closing-lid, light grey, for 7.5/ 9/ 12 liters **8.74 €**

**8012340** Closing-lid, light grey, for 10/ 12/ 15.5 liters **9.41 €**

**8012343** Bio-lid, light grey, for 7.5/ 9/ 12 liters **16.39 €**

**8012344** Bio-lid, light grey, for 10/ 12/ 15.5 liters **16.81 €**





### Cox® Box 275 S

The Cox® Box waste collection system is ideally suited for a multi-part front.

- with fixed silver-coloured metal lid
- with non-slip mat, TPE-coated on both sides
- for installation on existing pull-outs
- **the height of the entire system is only 275 mm**
- **The total lid can be mounted behind the top front to save space.**

Container fitting system/litres						
Cabinet/body	1000			1200		
	16	12	12	16	7	12
					7	16
					12	16
<b>Bio</b>	7	12	12	16	7	16
	7				7	16
					12	16

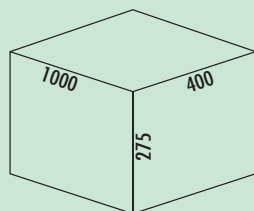
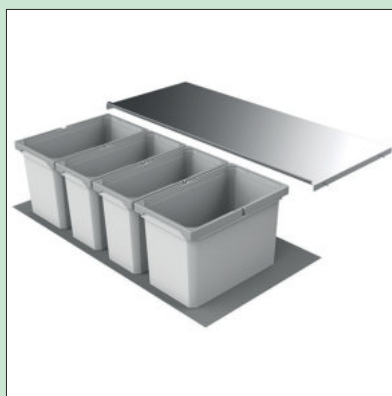

### Cox® Box 275 S/1000-4

For installation on existing pull-outs. With non-slip inlay mat and fixed complete lid.

- waste capacity 56 (2 x 16/2 x 12) liters
- bucket height 256 mm
- **total height 275 mm**
- **The complete lid can be mounted behind the top front to save space.**
- **suitable for Cox Work® utensils box (see catalogue 1 pages 154–156/24 EN)**

8012470 light grey 270.58 €

#### Optional accessories

8012342 Closing-lid, light grey, for 13/ 16/ 22/ 28 liters 9.41 €

8012341 Closing-lid, light grey, for 10/ 12/ 16/ 21 liters 8.74 €

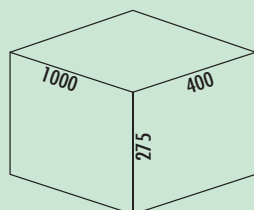

### Cox® Box 275 S/1000-5 Bio

For installation on existing pull-outs. With non-slip inlay mat, bio-lid and fixed complete lid.

- waste capacity 54 (1 x 16/2 x 12/2 x 7) liters
- bucket height 256 mm
- **total height 275 mm**
- **The complete lid can be mounted behind the top front to save space.**
- **suitable for Cox Work® utensils box (see catalogue 1 pages 154–156/24 EN)**

8012471 light grey 286.68 €

#### Optional accessories

8012342 Closing-lid, light grey, for 13/ 16/ 22/ 28 liters 9.41 €

8012341 Closing-lid, light grey, for 10/ 12/ 16/ 21 liters 8.74 €

8012338 Closing-lid, light grey, for 4/ 6/ 7/ 10/ 12.5 liters 5.97 €

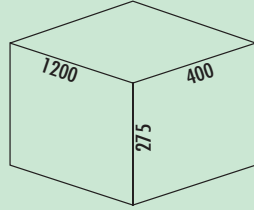

### Cox® Box 275 S/1200-6

For installation on existing pull-outs. With non-slip inlay mat and fixed complete lid.

- waste capacity 70 (2 x 16/2 x 12/2 x 7) liters
- bucket height 256 mm
- **total height 275 mm**
- **The complete lid can be mounted behind the top front to save space.**
- suitable for Cox Work® utensils box (see catalogue 1 pages 154–156/24 EN)

8012472 light grey 313.93 €

#### Optional accessories

8012342 Closing-lid, light grey, for 13/ 16/ 22/ 28 liters 9.41 €

8012341 Closing-lid, light grey, for 10/ 12/ 16/ 21 liters 8.74 €

8012338 Closing-lid, light grey, for 4/ 6/ 7/ 10/ 12.5 liters 5.97 €

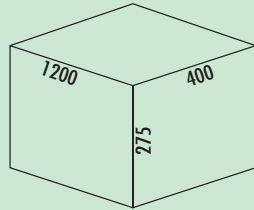

### Cox® Box 275 S/1200-6 Bio

For installation on existing pull-outs. With non-slip inlay mat, bio-lid and fixed complete lid.

- waste capacity 70 (2 x 16/2 x 12/2 x 7) liters
- bucket height 256 mm
- **total height 275 mm**
- **The complete lid can be mounted behind the top front to save space.**
- suitable for Cox Work® utensils box (see catalogue 1 pages 154–156/24 EN)

8012473 light grey 326.30 €

#### Optional accessories

8012342 Closing-lid, light grey, for 13/ 16/ 22/ 28 liters 9.41 €

8012341 Closing-lid, light grey, for 10/ 12/ 16/ 21 liters 8.74 €

8012338 Closing-lid, light grey, for 4/ 6/ 7/ 10/ 12.5 liters 5.97 €



### Cox® Box 275 K

The Cox® Box waste collection system is ideally suited for a multi-part front.

- with fixed silver-coloured metal lid
- with non-slip mat, TPE-coated on both sides
- for installation on existing pull-outs
- **the height of the entire system is only 275 mm**
- **The total lid can be mounted behind the top front to save space.**
- **for drawers with a depth of 400 mm**

Container fitting system/litres				
Corps	600	800	900	900
	12 12	12 12 12	12 12 12	9 9 9 9
Corps	1000		1200	
	12 9 9 12	12 9 12 9 12		

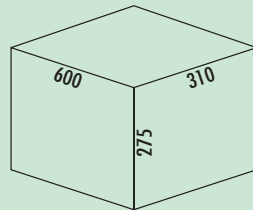

### Cox® Box 275 K/600-2

For installation on existing pull-outs. With non-slip inlay mat and fixed complete lid.

- waste capacity 24 (2 x 12) liters
- bucket height 256 mm
- **total height 275 mm**
- **The complete lid can be mounted behind the top front to save space.**

8012474 without bio lid, light grey 142.63 €

8012475 with bio lid, light grey 157.58 €

#### Optional accessories

8012340 Closing-lid, light grey, for 10/ 12/ 15.5 liters 9.41 €

8012344 Bio-lid, light grey, for 10/ 12/ 15.5 liters 16.81 €

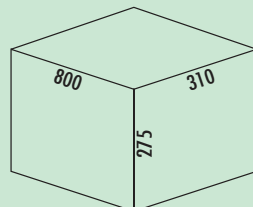
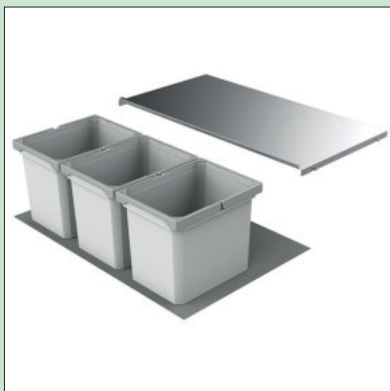

### Cox® Box 275 K/800-3

For installation on existing pull-outs. With non-slip inlay mat and fixed complete lid.

- waste capacity 36 (3 x 12) liters
- bucket height 256 mm
- **total height 275 mm**
- **The complete lid can be mounted behind the top front to save space.**

8012476 without bio lid, light grey 187.94 €

8012477 with bio lid, light grey 204.20 €

#### Optional accessories

8012340 Closing-lid, light grey, for 10/ 12/ 15.5 liters 9.41 €

8012344 Bio-lid, light grey, for 10/ 12/ 15.5 liters 16.81 €

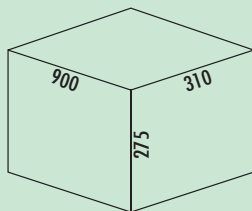
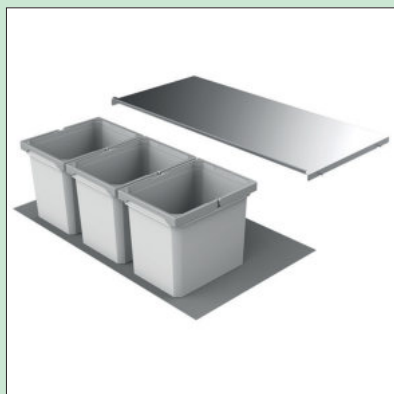

### Cox® Box 275 K/900-3

For installation on existing pull-outs. With non-slip inlay mat and fixed complete lid.

- waste 36 (3 x 12) liters
- bucket height 256 mm
- **total height 275 mm**
- **The total lid can be mounted behind the top front to save space.**

8012478 without bio lid, light grey 195.38 €

8012479 with bio lid, light grey 208.99 €

#### Optional accessories

8012340 Closing-lid, light grey, for 10/ 12/ 15.5 liters 9.41 €

8012344 Bio-lid, light grey, for 10/ 12/ 15.5 liters 16.81 €

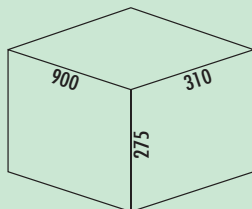
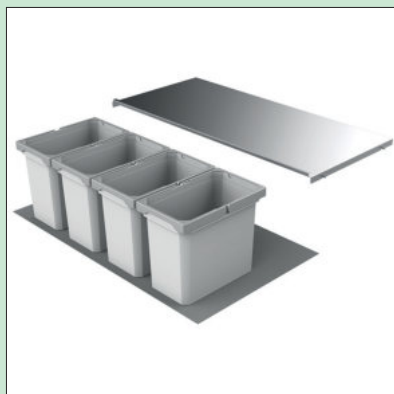

### Cox® Box 275 K/900-4

For installation on existing pull-outs. With non-slip inlay mat and fixed complete lid.

- waste capacity 36 (4 x 9) liters
- bucket height 256 mm
- **total height 275 mm**
- **The complete lid can be mounted behind the top front to save space.**

8012480 without bio lid, light grey 217.97 €

8012481 with bio lid, light grey 230.94 €

#### Optional accessories

8012339 Closing-lid, light grey, for 7.5/ 9/ 12 liters 8.74 €

8012343 Bio-lid, light grey, for 7.5/ 9/ 12 liters 16.39 €

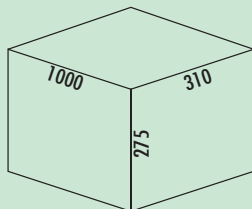
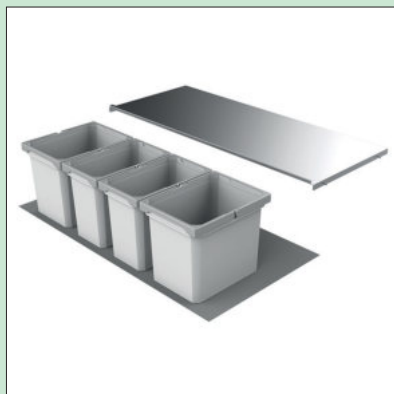

### Cox® Box 275 K/1000-4

For installation on existing pull-outs. With non-slip inlay mat and fixed complete lid.

- waste capacity 42 (2 x 12/2 x 9) liters
- bucket height 256 mm
- **total height 275 mm**
- **The complete lid can be mounted behind the top front to save space.**

8012482 without bio lid, light grey 226.59 €

8012483 with bio lid, light grey 246.57 €

#### Optional accessories

8012339 Closing-lid, light grey, for 7.5/ 9/ 12 liters 8.74 €

8012340 Closing-lid, light grey, for 10/ 12/ 15.5 liters 9.41 €

8012343 Bio-lid, light grey, for 7.5/ 9/ 12 liters 16.39 €

8012344 Bio-lid, light grey, for 10/ 12/ 15.5 liters 16.81 €

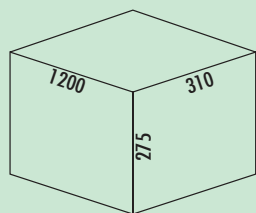

### Cox® Box 275 K/1200-5

For installation on existing pull-outs. With non-slip inlay mat and fixed complete lid.

- waste capacity 54 (3 x 12/2 x 9) liters
- bucket height 256 mm
- **total height 275 mm**
- **The complete lid can be mounted behind the top front to save space.**

**8012484** without bio lid, light grey **267.19 €**

**8012485** with bio lid, light grey **276.68 €**

#### Optional accessories

**8012339** Closing-lid, light grey, for 7.5/ 9/ 12 liters **8.74 €**

**8012340** Closing-lid, light grey, for 10/ 12/ 15.5 liters **9.41 €**

**8012343** Bio-lid, light grey, for 7.5/ 9/ 12 liters **16.39 €**

**8012344** Bio-lid, light grey, for 10/ 12/ 15.5 liters **16.81 €**

# SELECTAkit®

## Pull-out technology for existing pull-outs

### Cox® Box 360/350

Cox® Box 360/350 is the sophisticated individual built-in waste collector solution for existing pull-out technology.

- suitable for existing pull-outs from all manufacturers
- individual container-configuration for many applications
- easy installation due to cut-to-size anti-slip mat under the containers
- pull-out\* metal lid can be used as an additional depositing surface, powder-coated
- available for eight cabinet widths and for low container height 326 mm, installation height with metal lid 360/350 mm
- optional single closing lid or bio lid with activated carbon filter

\*with Cox® Box 360



### The Cox® Box convinces due to easy assembly:



1. Measure the bottom of the pull-out and cut anti-slip insert mat to size.

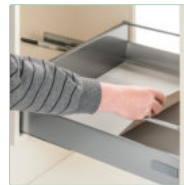

2. Insert anti-slip insert mat.



3. Place the container in the pull-out.



4. Measure the container height and transfer to body.



5. Mount the lid holder on the cabinet sides.



6. Insert the depositing lid into the holder. Finished!

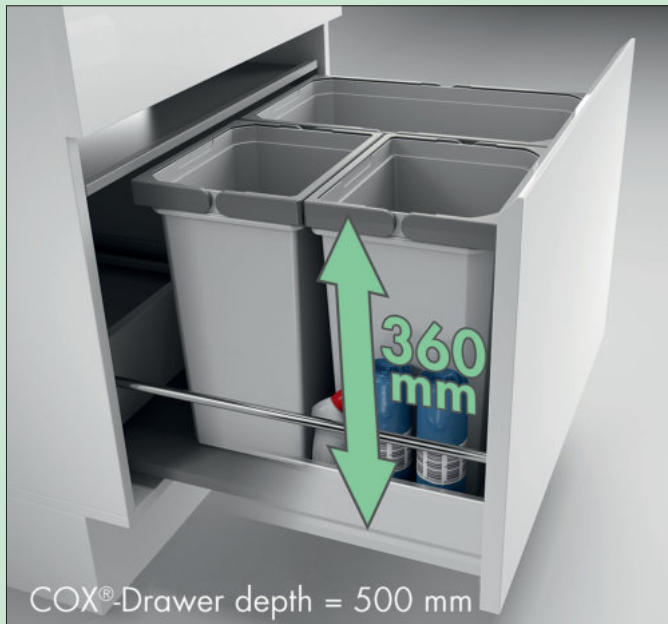

### Cox® Box 360 S

The Cox® Box waste collection system is ideally suited for a multi-part front.

- the height of the entire system is 360 mm
- with non-slip mat, TPE-coated on both sides
- for installation on existing pull-outs
- available with extractable metal lid

Container fitting system/litres					
Cabinet/body	400	400	450	450	600
	12 12	16 8,5	16 16	8,5 10 10	29 16

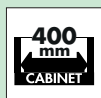
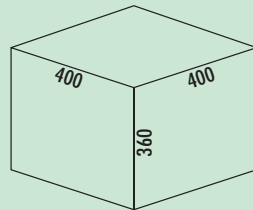

### Cox® Box 360 S/400-1

For all standard drawers. With non-slip inlay mat and pull-out complete lid.

- waste capacity 24.5 (1 x 16/1 x 8.5) liters
- bucket height 326 mm
- total height 360 mm
- The complete lid can be mounted behind the top front to save space.

8012407 light grey 149.22 €

#### Optional accessories

8012341 Closing-lid, light grey, for 10/ 12/ 16/ 21 liters 8.74 €

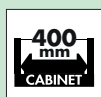
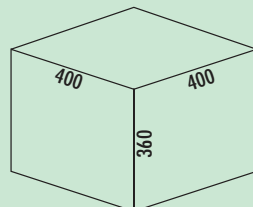

### Cox® Box 360 S/400-2

For all standard drawers. With non-slip inlay mat and pull-out complete lid.

- waste capacity 24 (2 x 12) liters
- bucket height 326 mm
- total height 360 mm
- The complete lid can be mounted behind the top front to save space.

8012408 without bio lid, light grey 154.29 €

8012409 with bio lid, light grey 164.87 €

#### Optional accessories

8012343 Bio-lid, light grey, for 7.5/ 9/ 12 liters 16.39 €

8012339 Closing-lid, light grey, for 7.5/ 9/ 12 liters 8.74 €

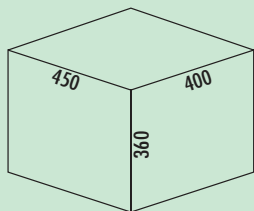

### Cox® Box 360 S/450-2

For all standard drawers. With non-slip inlay mat and pull-out complete lid.  
 – waste capacity 32 (2 x 16) liters  
 – bucket height 326 mm  
 – **total height 360 mm**  
 – **The complete lid can be mounted behind the top front to save space.**

8012412 light grey 155.38 €

#### Optional accessories

8012341 Closing-lid, light grey, for 10/ 12/ 16/ 21 liters 8.74 €

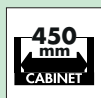
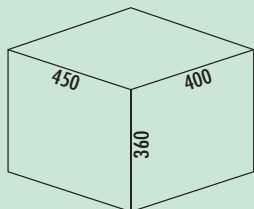

### Cox® Box 360 S/450-3

For all standard drawers. With non-slip inlay mat and pull-out complete lid.  
 – waste capacity 28.5 (2 x 10/1 x 8.5) liters  
 – bucket height 326 mm  
 – **total height 360 mm**  
 – **The complete lid can be mounted behind the top front to save space.**

8012410 without bio lid, light grey 171.64 €

8012411 with bio lid, light grey 184.66 €

#### Optional accessories

8012338 Closing-lid, light grey, for 4/ 6/ 7/ 10/ 12.5 liters 5.97 €

8011312 Bio-lid, light grey, for 4/ 6/ 7/ 10/ 12.5 liters 14.79 €

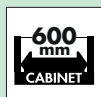
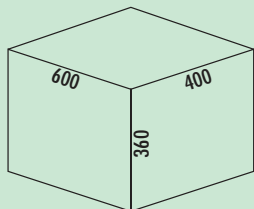

### Cox® Box 360 S/600-2

For all standard drawers. With non-slip inlay mat, top frame for bag attachment and pull-out complete lid.  
 – waste capacity 45 (1 x 29/1 x 16) liters  
 – bucket height 326 mm  
 – **total height 360 mm**  
 – **The complete lid can be mounted behind the top front to save space.**

8012417 light grey 212.94 €

#### Optional accessories

8012341 Closing-lid, light grey, for 10/ 12/ 16/ 21 liters 8.74 €



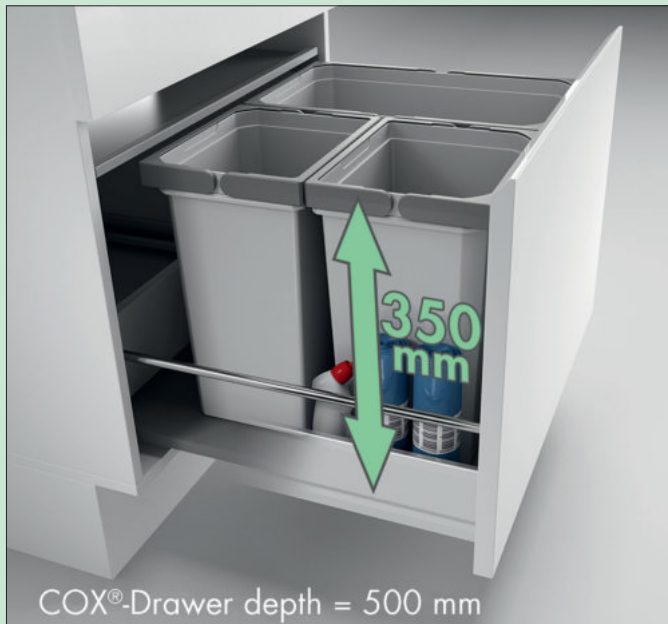

### Cox® Box 350 S

The Cox® Box waste collection system is ideally suited for a multi-part front.

- the height of the entire system is 350 mm
- with non-slip mat, TPE-coated on both sides
- for installation on existing pull-outs
- available with fixed metal lid

Container fitting system/litres																
Cabinet body	800			1000				1000				1200				
	16	29	16	22	16	16	22	10	16	16	22	10	16	22	16	22
								10				10				

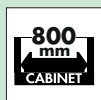
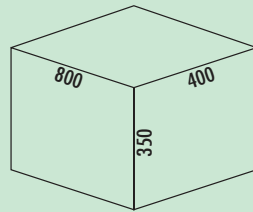

### Cox® Box 350 S/800-3

For all standard drawers. With non-slip inlay mat, top frame for bag attachment and fixed complete lid.

- waste capacity 61 (1 x 29/2 x 16) liters
- bucket height 326 mm
- total height 350 mm
- The complete lid can be mounted behind the top front to save space.

8012420 light grey 218.33 €

#### Optional accessories

8012341 Closing-lid, light grey, for 10/ 12/ 16/ 21 liters 8.74 €

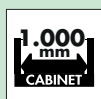
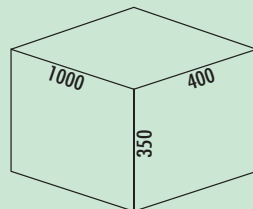

### Cox® Box 350 S/1000-4

For all standard drawers. With non-slip inlay mat and fixed complete lid.

- waste capacity 76 (2 x 22/2 x 16) liters
- bucket height 326 mm
- total height 350 mm
- The total lid can be mounted behind the top front to save space.
- suitable for Cox Work® utensils box (see catalogue 1 pages 154–156/24 EN)

8012426 light grey 234.69 €

#### Optional accessories

8012342 Closing-lid, light grey, for 13/ 16/ 22/ 28 liters 9.41 €

8012341 Closing-lid, light grey, for 10/ 12/ 16/ 21 liters 8.74 €

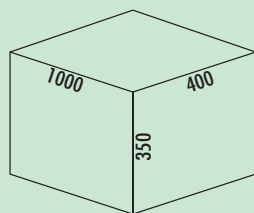

### Cox® Box 350 S/1000-5

For all standard drawers. With non-slip inlay mat and fixed complete lid.

- waste capacity 74 (1 x 22/2 x 16/2 x 10) liters
- bucket height 326 mm
- **total height 350 mm**
- suitable for Cox Work® utensils box (see catalogue 1 pages 154–156/24 EN)

**8012424** without bio lid, light grey **249.09 €**

**8012425** with bio lid, light grey **263.67 €**

#### Optional accessories

**8012342** Closing-lid, light grey, for 13/ 16/ 22/ 28 liters **9.41 €**

**8012341** Closing-lid, light grey, for 10/ 12/ 16/ 21 liters **8.74 €**

**8012338** Closing-lid, light grey, for 4/ 6/ 7/ 10/ 12.5 liters **5.97 €**

**8011312** Bio-lid, light grey, for 4/ 6/ 7/ 10/ 12.5 liters **14.79 €**

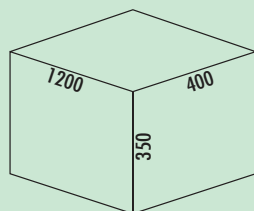

### Cox® Box 350 S/1200-6

For all standard drawers. With non-slip inlay mat and fixed complete lid.

- waste capacity 96 (2 x 22/2 x 16/2 x 10) liters
- bucket height 326 mm
- **total height 350 mm**
- suitable for Cox Work® utensils box (see catalogue 1 pages 154–156/24 EN)

**8012427** without bio lid, light grey **294.09 €**

**8012428** with bio lid, light grey **307.22 €**

#### Optional accessories

**8012342** Closing-lid, light grey, for 13/ 16/ 22/ 28 liters **9.41 €**

**8012341** Closing-lid, light grey, for 10/ 12/ 16/ 21 liters **8.74 €**

**8012338** Closing-lid, light grey, for 4/ 6/ 7/ 10/ 12.5 liters **5.97 €**

**8011312** Bio-lid, light grey, for 4/ 6/ 7/ 10/ 12.5 liters **14.79 €**



### Cox® Giallo

Cox® Giallo lets the bin bag disappear elegantly and invisibly behind the front. An integrated clamping bracket fixes the bin bag. The collecting tray below the bin bag ensures that, if the worst comes to the worst, no liquids get into the furniture body. The integrated metal lid minimises odours.

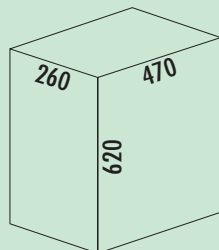

### Cox® Giallo

Pullout box frame for the bin bag, for mounting on existing pull-outs.

- for all common pullouts
- waste volume approx. 43 liters
- total height **620 mm**
- metal lid (side wall mounting)
- mounting: pull-out base and front panel
- with removable collecting tray and foldable holding clamp
- **The clear internal width of the pullout must not be less than 180 mm.**

8012378 silver

287.48 €



### X-LINE

The X-LINE series for existing drawer pull-outs combines practical advantages with space-saving design. The waste separation systems can be quickly installed and are also easy to remove. This makes cleaning as simple as possible. With the adjustable ratchet included, the waste system can be used in all drawers with a depth of 400–500 mm. This ensures that the storage space is optimally utilised, and the system adapts seamlessly to the different widths, heights and depths of the kitchen installations.

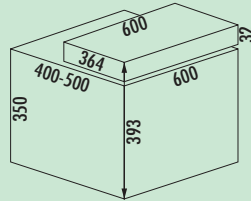
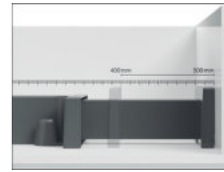
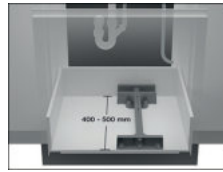

### X-LINE 600/M7 with Basic drawer

For mounting on existing pull-outs. Drawer with part pull-out on plastic runners.

- variable installation depth 366–494 mm
- installation height 367 mm
- waste volume 50 (1 x 35/1 x 15) liters

**8011295** anthracite **263.53 €**

#### Optional accessories

**8011084** X-LINE Dividing strip, anthracite **37.82 €**

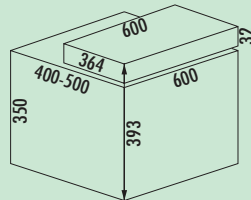

### X-LINE 600/M5 with Basic drawer

For mounting on existing pull-outs. Drawer with part pull-out on plastic runners.

- variable installation depth 366–494 mm
- installation height 367 mm
- waste volume 48 (1 x 35/1 x 8/1 x 5) liters + two additional containers (1 x 1/1 x 0.5 l)

**8011292** anthracite **322.71 €**

#### Optional accessories

**8011084** X-LINE Dividing strip, anthracite **37.82 €**

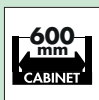

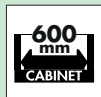
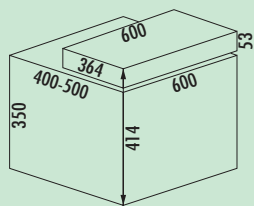

### X-LINE 600/M7 with Premium drawer

For mounting on existing pull-outs. Drawer with full pull-out on ball bearing runners, rotating back panel and two additional bowls (0.9/1.3 l).

- variable installation depth 366–494 mm
- installation height 367 mm
- waste volume 50 (1 x 35/1 x 15) liters

**8011296** anthracite **325.21 €**

#### Optional accessories

**8011084** X-LINE Dividing strip, anthracite **37.82 €**

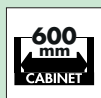
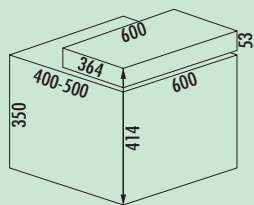

### X-LINE 600/M5 with Premium drawer

For mounting on existing pull-outs. Drawer with full pull-out on ball bearing runners, rotating back panel and two additional bowls (1.3/1.3 l).

- variable installation depth 366–494 mm
- installation height 367 mm
- waste volume 48 (1 x 35/1 x 8/1 x 5) liters + two additional containers (1 x 1/1 x 0.5 l)

**8011294** anthracite **388.76 €**

#### Optional accessories

**8011084** X-LINE Dividing strip, anthracite **37.82 €**

Waste collectors

# SELECTAkit®

## Pull-out technology for rotating doors

The perfect supplement for functionality and ergonomics



■ Clap	Page 206–208	■ Bio Trio DT	Page 217
Double	Page 209	Kitchen Box	Page 217
Trenta 1	Page 210	Solo	Page 218
Double Shorty 1	Page 211	Tandem 7	Page 218
Trio Shorty	Page 211	Trenta 8/7	Page 219
Double Shorty plus	Page 212	Cleaning agent pullout	
Double 4	Page 212	Carry	Page 220
Trenta 5	Page 212	Tandem 7 K	Page 220
Quarta 1	Page 213	Tandem S	Page 221–222
Double 2	Page 213	Tandem 4/5	Page 222
Trenta 6	Page 213	Easy Cargo	Page 223
Bio Single 30 DT	Page 214	Big Double	Page 223
Big Boy 30	Page 214	Corner Boy	Page 224
Big Boy 40	Page 214	Rondo plus	Page 225–226
Double Master	Page 215	Rondo plus deflector for hoses with shower head	Page 226
Bio Double Master	Page 215	Rolling cart DS	Page 227–229
Trio Master	Page 215	Double Master 2 DS	Page 228
Bio Master	Page 216	Trio Master 3 DS	Page 229
Double Master Maxi 40 DT	Page 216	Double 2 DS	Page 229
Bio Trio Maxi 40 DT	Page 216	Trenta 6 DS	Page 229
Bio Double 30 DT	Page 217		

Suitable for the following front layouts:



Full front

Front panel with one division

Please check the heights of the product groups.



### Clap

The successful combination of convenience properties in smooth-running design with the optional versatility of waste separation down to fractions makes Clap an all-rounder in its class. Ultimately, its attractiveness is not only defined by its economic construction and design. Corresponding to the Naber product concept "the next generation", all materials employed are fully recyclable.

- fitted with telescopic full pull-out with ball bearings
- sturdy plastic containers for individual separation of recyclable materials
- covering of the body structure may be used for storage of dishwashing paraphernalia
- easy installation due to simple mounting on the cabinet floor

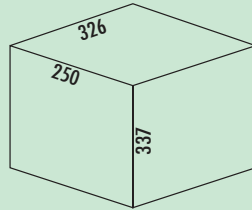

### Clap 1/300-1

- waste capacity 15 liters
- technology: full pull-out
- fitting: cabinet bottom
- **the ideal space saver with an installation height of only 337 mm**

8011450 anthracite

88.07 €

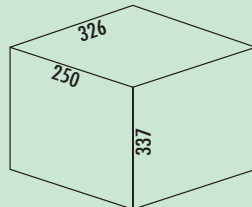

### Clap 1/300-2

- waste capacity 15 (2 x 7.5) liters
- technology: full pull-out
- fitting: cabinet bottom
- **the ideal space saver with an installation height of only 337 mm**

8011451 anthracite

102.44 €

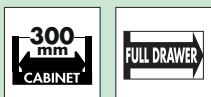



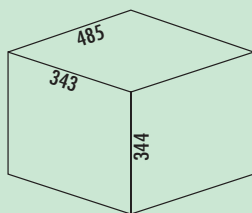
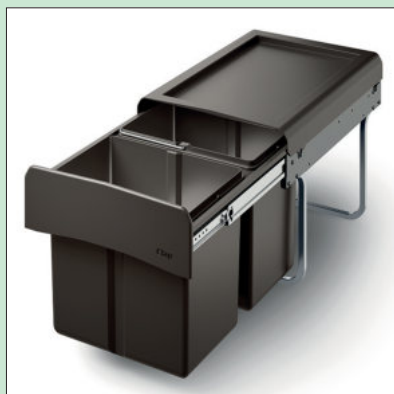

### Clap 2/450-2

- waste capacity 30 (2 x 15) liters
- technology: full pull-out
- fitting: cabinet bottom
- **the ideal space saver with an installation height of only 344 mm**

8011452 anthracite

105.97 €

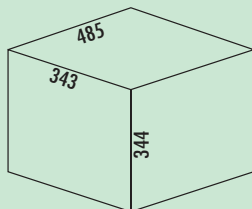

### Clap 2/450-3

- waste capacity 30 (2 x 7.5/1 x 15) liters
- technology: full pull-out
- fitting: cabinet bottom
- **the ideal space saver with an installation height of only 344 mm**

8011453 anthracite

125.80 €





### Clap 3

Space-saving built-in waste collection system with full pull-out technology for rotating doors.

- installation height 339 mm and installation depth 327 mm

Ideally suited for installation with sub-frame appliances, water connections and siphon in the floor cabinet.

- despite its shortness 30 l filling volume
- minimum cabinet width 500 mm
- simple floor mounting

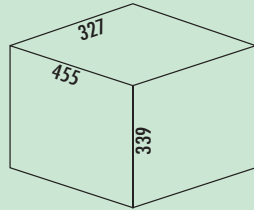

### Clap 3/500-2

- waste capacity 30 (2 x 15) liters
- technology: full pull-out
- fitting: cabinet bottom
- the ideal space saver with an installation height of only 339 mm
- only 327 mm installation depth

8011454 anthracite

114.96 €

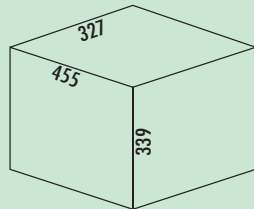

### Clap 3/500-3

- waste capacity 30 (2 x 7.5/1 x 15) liters
- technology: full pull-out
- fitting: cabinet bottom
- the ideal space saver with an installation height of only 339 mm
- only 327 mm installation depth

8011455 anthracite

123.11 €

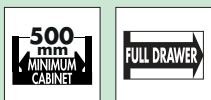

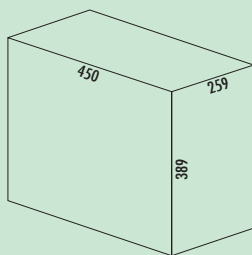

### Double 1

- waste capacity 30 (2 x 15) liters
- technology: partial drawer
- fitting: cabinet bottom

**8011026** anthracite/grey

**96.13 €**

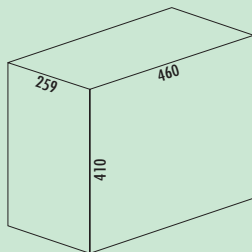

### Double deluxe

- waste capacity 30 (2 x 15) liters
- technology: full pull-out
- fitting: cabinet bottom

**8011012** anthracite

**116.81 €**

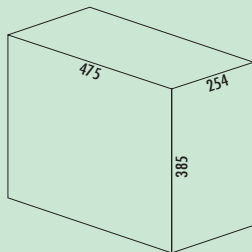

### Double 3

- waste capacity 30 (1 x 20/1 x 10) liters
- technology: full pull-out
- fitting: cabinet bottom

**8011112** aluminium grey

**151.85 €**

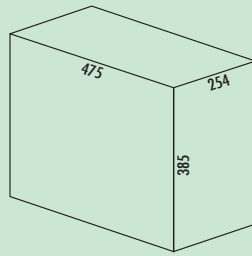

### Trenta 1

- waste capacity 30 (3 x 10) liters
- technology: full pull-out
- fitting: cabinet bottom

8011027 aluminium grey

143.70 €





### Double Shorby

- Built-in waste collector with full pull-out technology for rotating doors.
- installation height only 345 mm and installation depth only 325 mm!  
Therefore creates space for siphon, water connections and sub-frame equipment
  - despite the shortness – 30 l capacity
  - minimum cabinet width 500 mm
  - quick and easy floor installation

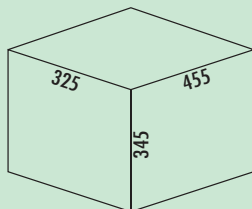

### Double Shorby 1

- waste capacity 30 (2 x 15) liters
- technology: full pull-out
- fitting: cabinet bottom
- **with an installation height of only 345 mm and an installation depth of only 325 mm the ideal space saver**

8011058 aluminium grey

121.26 €

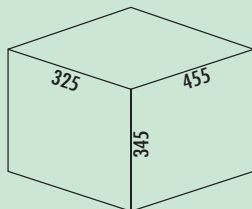

### Trio Shorby

- waste capacity 30 (2 x 7.5/1 x 15) liters
- technology: full pull-out
- fitting: cabinet bottom
- **with an installation height of only 345 mm and an installation depth of only 325 mm the ideal space saver**

8011188 aluminium grey

136.55 €

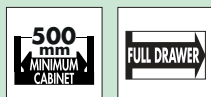

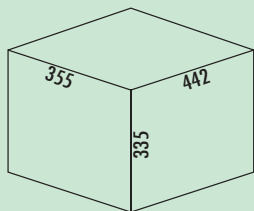

### Double Shorty plus

- waste capacity 30 (2 x 15) liters
- technology: full pull-out
- fitting: cabinet bottom
- **complete with cam for rotating doors**
- **a door opening angle of 110° is required**
- **the ideal space saver with an installation height of only 335 mm**

8011208 anthracite

209.33 €

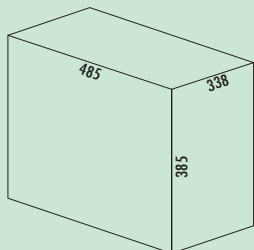
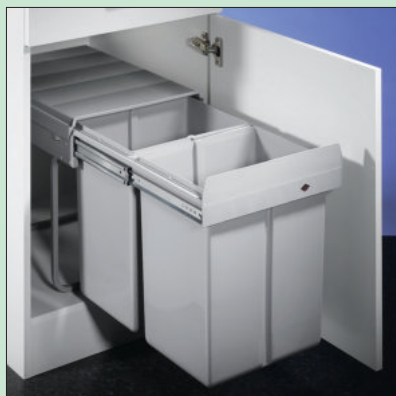

### Double 4

- waste capacity 40 (2 x 20) liters
- technology: full pull-out
- fitting: cabinet bottom

8011115 aluminium grey

175.21 €

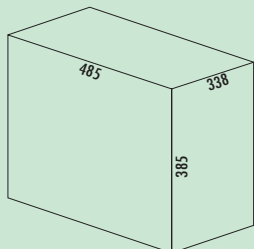

### Trenta 5

- waste capacity 40 (2 x 10/1 x 20) liters
- technology: full pull-out
- fitting: cabinet bottom

8011113 aluminium grey

178.74 €

#### Optional accessories

8011195 Closing-lid, aluminium grey, for 7, 8, 10 liters

10.92 €

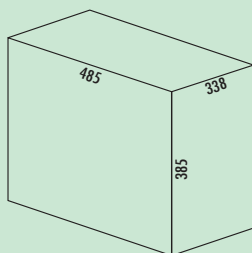
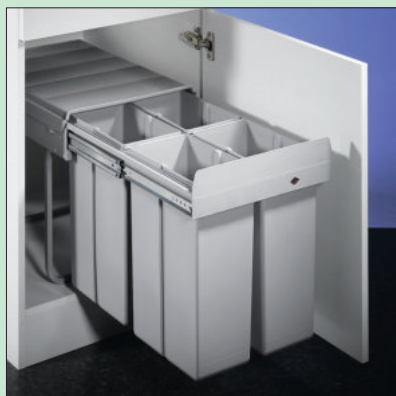

### Quarta 1

- waste capacity 40 (4 x 10) liters
- technology: full pull-out
- fitting: cabinet bottom

8011028 aluminium grey 176.05 €

#### Optional accessories

8011195 Closing-lid, aluminium grey, for 7, 8, 10 liters 10.92 €

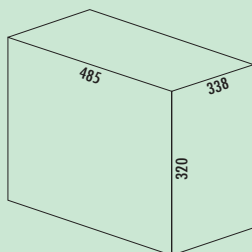

### Double 2

- waste capacity 32 (2 x 16) liters
- technology: full pull-out
- fitting: cabinet bottom
- **the ideal space saver with an installation height of only 320 mm**

8011111 aluminium grey 138.32 €

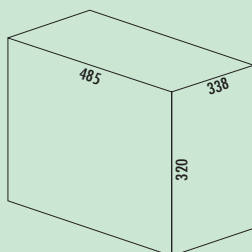

### Trenta 6

With variably employable exchangeable tie bar.

- waste capacity 32 (2 x 8/1 x 16) liters
- technology: full pull-out
- fitting: cabinet bottom
- **the ideal space saver with an installation height of only 320 mm**

8011116 aluminium grey 151.85 €

#### Optional accessories

8011195 Closing-lid, aluminium grey, for 7, 8, 10 liters 10.92 €

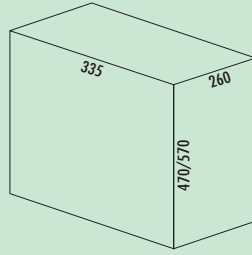

**Bio Single 30 DT**

- waste capacity 26 or 32 liters
- technology: full pull-out
- frame/guide silver
- complete lid aluminium grey
- fitting: cabinet bottom

<b>8011010</b> aluminium grey, 26 l, H 470 mm	<b>161.68 €</b>
<b>8011014</b> aluminium grey, 32 l, H 570 mm	<b>167.98 €</b>

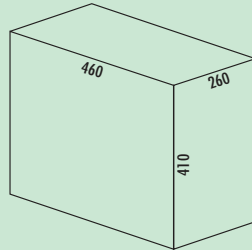

**Big Boy 30**

- waste capacity 30 liters
- technology: full pull-out
- frame/guide silver
- complete lid aluminium grey
- fitting: cabinet bottom

<b>8011044</b> aluminium grey	<b>167.98 €</b>
-------------------------------	-----------------

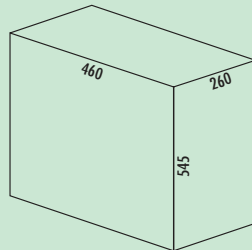

**Big Boy 40**

- waste capacity 40 liters
- technology: full pull-out
- frame/guide silver
- complete lid aluminium grey
- fitting: cabinet bottom

<b>8011018</b> aluminium grey	<b>177.90 €</b>
-------------------------------	-----------------



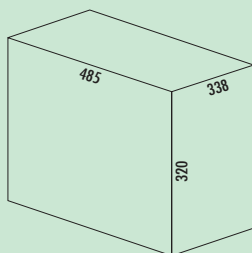

### Double Master

- waste capacity 32 (2 x 16) liters
- technology: full pull-out
- frame/guide silver
- complete lid anthracite
- fitting: cabinet bottom
- **the ideal space saver with an installation height of only 320 mm**

8012086 anthracite

142.86 €

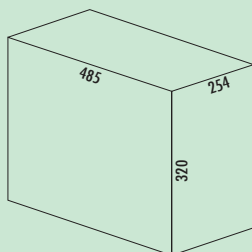

### Bio Double Master

- waste capacity 24 (1 x 16/1 x 8) liters
- technology: full pull-out
- frame/guide silver
- complete lid anthracite
- fitting: cabinet bottom
- **the ideal space saver with an installation height of only 320 mm**

8012075 with bio lid, anthracite

170.67 €

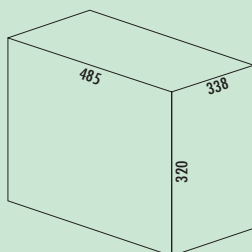

### Trio Master

With variably employable exchangeable tie bar.

- waste capacity 32 (1 x 16/2 x 8) liters
- technology: full pull-out
- frame/guide silver
- complete lid anthracite
- fitting: cabinet bottom
- **the ideal space saver with an installation height of only 320 mm**

8012087 with bio lid, anthracite

170.67 €

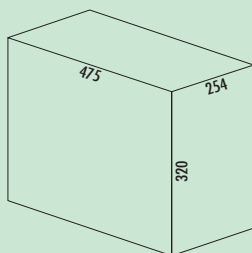

### Bio Master

- waste capacity 24 (3 x 8) liters
- technology: full pull-out
- frame/guide silver
- complete lid anthracite
- fitting: cabinet bottom
- **the ideal space saver with an installation height of only 320 mm**

**8012088** with bio lid, anthracite

**167.06 €**

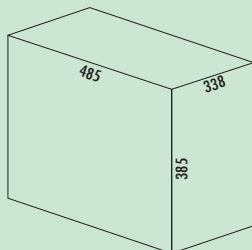

### Double Master Maxi 40 DT

- waste capacity 40 (2 x 20) liters
- technology: full pull-out
- installat. height 38.5 cm
- frame/guide silver
- complete lid anthracite
- fitting: cabinet bottom

**8012077** anthracite

**196.72 €**

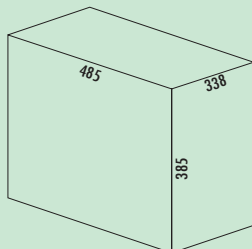

### Bio Trio Maxi 40 DT

- waste capacity 40 (1 x 20/2 x 10) liters
- technology: full pull-out
- installat. height 38.5 cm
- frame/guide silver
- complete lid anthracite
- fitting: cabinet bottom

**8012078** anthracite

**196.72 €**

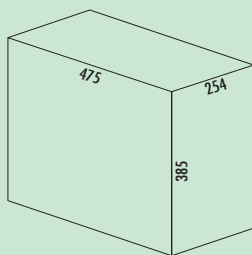

### Bio Double 30 DT

- waste capacity 30 (1 x 20/1 x 10) liters
- technology: full pull-out
- installat. height 38.5 cm
- frame/guide silver
- complete lid anthracite
- fitting: cabinet bottom

**8012074** with bio lid, anthracite

**176.05 €**

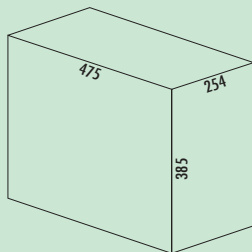

### Bio Trio DT

- waste capacity 30 (3 x 10) liters
- technology: full pull-out
- installat. height 38.5 cm
- frame/guide silver
- complete lid anthracite
- fitting: cabinet bottom

**8012089** with bio lid, anthracite

**163.53 €**



### Kitchen Box

Optimal accessories. Multifunctional container as additional container for attaching to door fronts or placing on the work surface. Universally employable as a bio-waste container or for storing e.g. cleaning utensils.

- 185 x 248 x 185 mm (H x W x D)

**8012001** anthracite

**20.92 €**

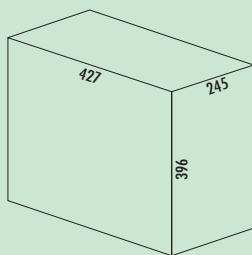

### Solo 3635

- waste capacity 20 liters
- technology: full pull-out
- frame/guide silver
- complete lid graphite grey
- fitting: cabinet bottom

**8011263** graphite grey

**116.81 €**

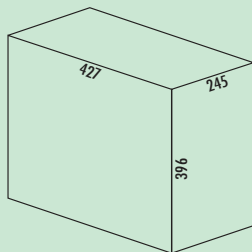

### Solo 3636

- incl. cam
- waste capacity 20 liters
- technology: full pull-out incl. cam
- frame/guide silver
- complete lid graphite grey
- fitting: cabinet bottom

**8011264** graphite grey

**120.42 €**

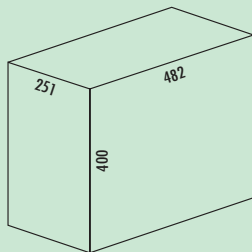

### Tandem 7

- waste capacity 30 (2 x 15) liters
- technology: full pull-out
- fitting: cabinet bottom

**8011067** graphite grey

**154.54 €**

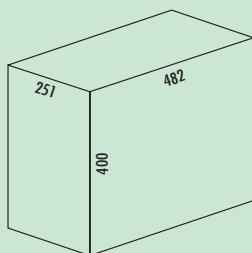

### Trenta 8

- waste capacity 30 (3 x 10) liters
- technology: full pull-out
- fitting: cabinet bottom

8011216 graphite grey

158.07 €

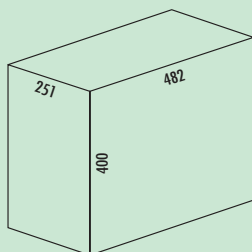

### Trenta 7

- waste capacity 29 (2 x 7/1 x 15) liters
- technology: full pull-out
- fitting: cabinet bottom

8011042 graphite grey

164.37 €

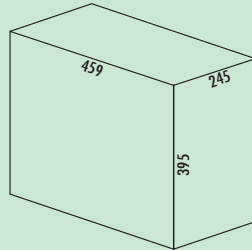

### Cleaning agent pullout Carry

Mobile and flexible pull-out.

- carrying baskets can be clipped onto the pull-out system with self-closing mechanism and attenuation – closes gently and quietly
- With the mobile utensils baskets e.g. cleaning agents can be carried to where you need them.
- simple floor mounting

Also for combination with waste separation systems in cabinets from 600 mm.

8011023 light grey

313.53 €

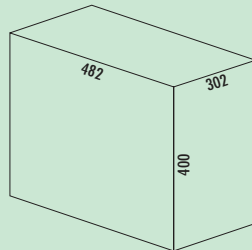

### Tandem 7 K

- incl. dustpan set
- waste capacity 30 (2 x 15) liters
- technology: full pull-out
- fitting: cabinet bottom

8011034 light grey

211.09 €





### Tandem S

Built-in waste collector with full pull-out technology for rotating doors, ideal for saving space!

Offers the right model for every requirement:

- for floor cabinets with a width of at least 500 mm
- Ideal space saver with only 350 mm installation height and 330 mm installation depth! Therefore creates space for siphon, water connections and sub-frame equipment.
- quick and easy floor installation

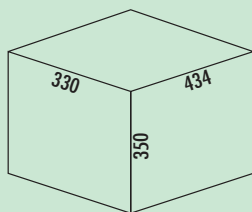
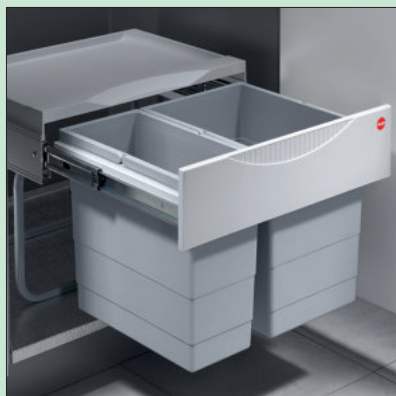

### Tandem S 2

- waste capacity 30 (1 x 12/1 x 18) liters
- technology: full pull-out
- fitting: cabinet bottom
- **the ideal space saver with an installation height of only 350 mm and an installation depth of 330 mm**

8011217 light grey

167.06 €

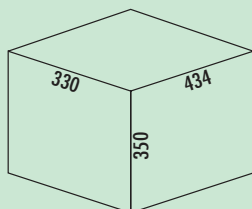
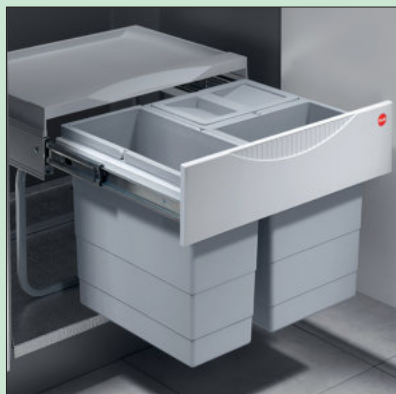

### Tandem S 3

- waste capacity 28 (2 x 8/1 x 12) liters
- technology: full pull-out
- fitting: cabinet bottom
- **incl. cover lid for 8 liters bin**
- **the ideal space saver with an installation height of only 350 mm and an installation depth of 330 mm**

8011218 light grey

176.97 €

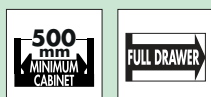

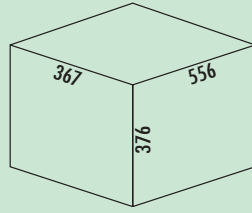

### Tandem S 2 plus

- Complete with cam for rotating doors.
- waste capacity 30 (1 x 18/1 x 12) liters
- technology: full pull-out
- fitting: cabinet bottom/side wall (lid)
- **the ideal space saver with an installation height of only 376 mm**

8011219 light grey

236.22 €

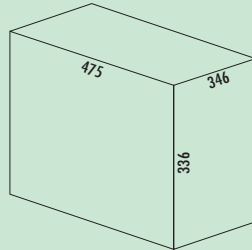

### Tandem 4

- waste capacity 36 (2 x 18) liters
- technology: full pull-out
- fitting: cabinet bottom
- **the ideal space saver with an installation height of only 336 mm**

8011157 light grey

194.96 €

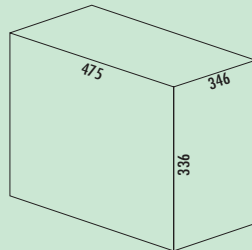

### Tandem 5

- Including closing lid for bio waste container.
- waste capacity 34 (2 x 8/1 x 18) liters
- technology: full pull-out
- fitting: cabinet bottom
- **incl. cover lid for 8 litre bin**
- **the ideal space saver with an installation height of only 336 mm**

8011158 light grey

194.96 €



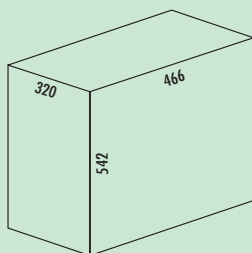

### Easy Cargo 1

- waste capacity 42 liters
- technology: full pull-out
- fitting: cabinet bottom

**8011254** aluminium grey

**257.82 €**

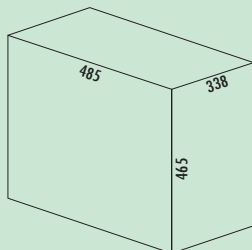

### Big Double

- waste capacity 52 (2 x 26) liters
- technology: full pull-out
- frame/guide aluminium grey
- complete lid aluminium grey
- fitting: cabinet bottom

**8011222** aluminium grey

**212.02 €**



### Corner Boy

Advantages:

- two large, detachable, sturdy containers for cleaning agents, with full pull-outs for drawing out
- plastic pans detachable
- simple removal and insertion of the lateral containers possible by swivelling the waste collector

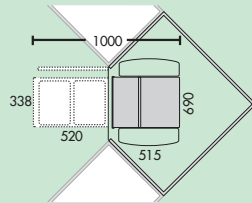
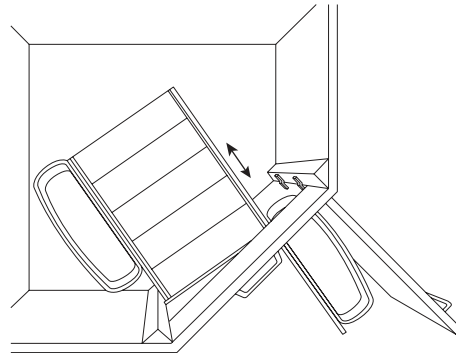

### Corner Boy 2 (for diagonal corner cupboards)

Complete with two plastic pans.

For corner cabinets from 900 x 900 mm.

- waste capacity 32 (2 x 16) liters
- technology: full pull-out/swivelling
- frame/guide silver
- complete lid aluminium grey
- minimum door span 380 mm
- fitting: cabinet bottom/rotatable (22° to each side)
- **the ideal space saver with an installation height of only 335 mm**
- **plastic pans may be drawn out**

8012083 aluminium grey

313.53 €

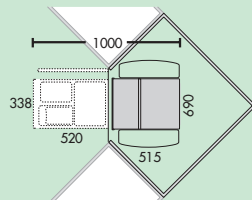

### Corner Boy 3 (for diagonal corner cupboards)

Complete with bio-lid and two plastic pans.

For corner cabinets from 900 x 900 mm.

- waste capacity 32 (2 x 8/1 x 16) liters
- technology: full pull-out/swivelling
- frame/guide silver
- complete lid aluminium grey
- minimum door span 380 mm
- fitting: cabinet bottom/rotatable (22° to each side)
- **the ideal space saver with an installation height of only 335 mm**
- **plastic pans may be drawn out**

8012084 aluminium grey

319.83 €





### Rondo plus

- for corner cabinets from 900 x 900 mm
- manual pull-out with handle faceplate
- waste bucket optionally for 2-fold, 3-fold or 4-fold separation
- additional lid with handle recess against bothersome odours for one 8 liter organic waste bucket
- telescopic rails on ball bearings glide very easily and ensure full pull-out of the waste bucket
- pans for paraphernalia, for instance for cleaning paraphernalia, the pans may easily be removed for cleaning
- metal parts with high-quality finish

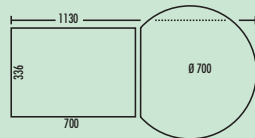

### Rondo 1 plus

For corner cabinets from 900 x 900 mm.

- waste capacity 36 (2 x 18) liters

**Extra equipment:**

- multi-functional bucket (12 liters) with perforated lid
- 2 pans for paraphernalia
- complete lid with depositing surface
- technology: full pull-out/rotatable
- fitting: cabinet bottom/360° rotatable
- the ideal space saver with an installation height of only 351 mm

8011161 light grey

371.01 €

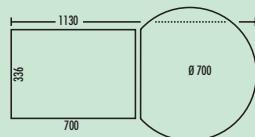

### Rondo 2 plus

For corner cabinets from 900 x 900 mm.

- waste capacity: 34 (1 x 18/2 x 8) liters

**Extra equipment:**

- multi-functional bucket (12 litres) with perforated lid
- 2 pans for paraphernalia
- complete lid with depositing surface
- technology: full pull-out, rotatable
- fitting: cabinet bottom, 360° rotatable
- the ideal space saver with an installation height of only 351 mm

8011162 light grey

381.76 €



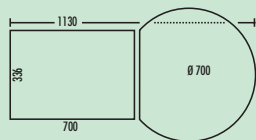

### Rondo 3 plus

For corner cabinets from 900 x 900 mm.

– waste capacity 32 (4 x 8) liters

**Extra equipment:**

- multi-functional bucket (12 liters) with perforated lid
- 2 pans for paraphernalia
- complete lid with depositing surface
- technology: full pull-out/rotatable
- fitting: cabinet bottom/360° rotatable
- the ideal space saver with an installation height of only 351 mm

8011163 light grey

397.06 €

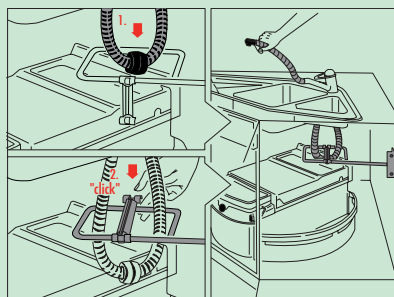

### Rondo plus deflector for hoses with shower head

For all common hose fittings with shower head.

- easy installation by screwing to the floor cupboard
- forced routing of the hose in the remaining free spaces, right, left, rear, top
- installed appliances are not impaired in their function
- metal yoke, powder coated with epoxy resin
- optimal accessory for Rondo plus

8011175 white

19.83 €

# SELECTAkit®

## Corner solutions



### Rolling cart DS

#### Optimum utilisation of space down to the last corner

"How can I use the corners?" is a question some kitchen planners may ask. Especially when every centimetre is precious. You can achieve optimum space usage down to the last corner by employing the rolling cart DS for all rotating door built-in waste collectors and separating systems (see next page). Using the cart, which may be moved all the way back, the spaces to the sides of the waste collector remain accessible and may be used as storage space for cleaning paraphernalia and other items.



#### Pulled-out position

Pulled-out all the way to the front, the waste collector can be comfortably filled from above.



#### Parking position

The waste collector takes up very little space in parking position. From this basic position, it may be slid to the front as well as, after shortly lifting it, to the back.



#### Resting position

Lifting the waste collector releases the lock of the rolling cart. Now, it may be pushed all the way back. The lateral storage spaces are therefore easily accessible.

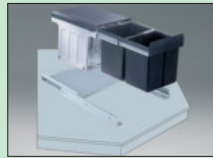
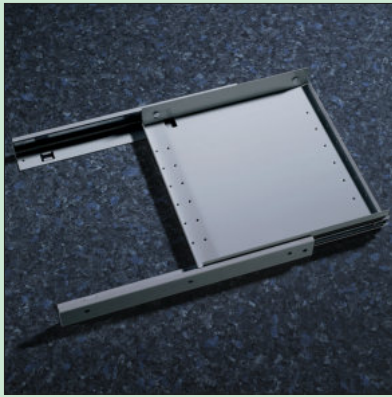

### Rolling cart DS

Installation in diagonal corner cabinets with a door span of at least 355 mm.

Also suitable for cabinets underneath sinks.

- 55 x 355 x 410/606 mm (H x W x D)
- sturdy, powder-coated steel plate

8011134 white 75.46 €

8011136 aluminium grey 75.46 €

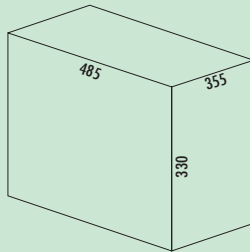

### Double Master 2 DS

Including rolling cart DS.

- waste capacity 32 (2 x 16) liters
- technology: full pull-out
- frame/guide silver
- complete lid anthracite
- the ideal space saver with an installation height of only 330 mm

8010186 anthracite 205.77 €



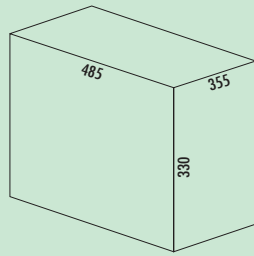

### Trio Master 3 DS

- Complete with bio-lid. incl. rolling cart DS.
- waste capacity 32 (2 x 8/1 x 16) liters
  - technology: full pull-out
  - frame/guide silver
  - complete lid anthracite
  - **the ideal space saver with an installation height of only 330 mm**

8010187 anthracite

237.52 €

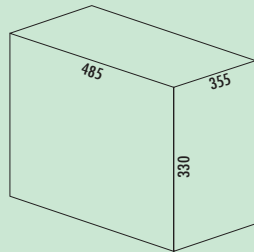

### Double 2 DS

- Including rolling cart DS.
- waste capacity 32 (2 x 16) liters
  - technology: full pull-out
  - fitting: cabinet bottom
  - **the ideal space saver with an installation height of only 330 mm**

8010111 aluminium grey

197.21 €

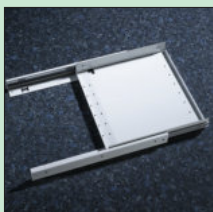
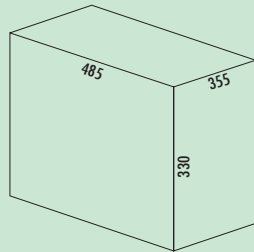

### Trenta 6 DS

- Including rolling cart DS.
- waste capacity 32 (2 x 8/1 x 16) liters
  - technology: full pull-out
  - fitting: cabinet bottom
  - **the ideal space saver with an installation height of only 330 mm**

8010116 aluminium grey

209.13 €

#### Optional accessories

8011195 Closing-lid, aluminium grey, for 7, 8, 10 liters

10.92 €

Waste collectors



# SELECTAkit®

## Swivel technology for rotating doors

The technology of  
shorter distances



■ Cabbì® junior	Page 232–233
Cabbì®	Page 234–235
Cox® Beep	Page 236
Müllex Single 35	Page 237
Müllex Euro Flexx	Page 237
Vario	Page 237–238
Öko	Page 239
Uno	Page 239
Duo	Page 239

Suitable for the following  
front layouts:



Full front



Front panel  
with one  
division

Please check the heights of the product  
groups.

# SELECTAkit®

## Swivel technology for rotating doors

### Cabbi® & Cabbi® junior

An intelligent solution with easy handling for collecting organic waste without bothersome odours. A tightly fitting bio-lid with detachable perforated cartridge, which is fitted with an activated charcoal polyester fleece as odour filter.

Overall, the Cabbi® concept is convincing due to its extraordinary quality and a large variety of performance characteristics:

- very sturdy carrying axle construction
- may be easily installed
- optimum use of space
- easy-action cam
- lid with raising/lowering technology
- easy access to the floor cupboard
- clamping strips ensure fixed position
- environmentally compatible basic materials
- convenient wire basket as accessory
- tightly fitting bio-lid

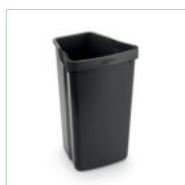

### Cabbi® & Cabbi® junior are easily installed:



1. Assemble rotating support and pipe support bracket.



2. Complete and insert rotating rods.



3. Install cam.



4. Install basket in rotating bar.

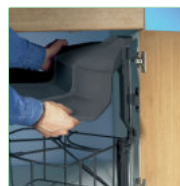

5. Clip lid on.



6. Insert containers.

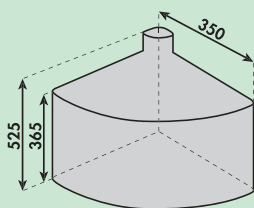

### Cabbi® junior 1

- waste capacity 18 liters
- technology: swivel technology
- fitting: cabinet bottom/-wall

8013200 anthracite

121.85 €

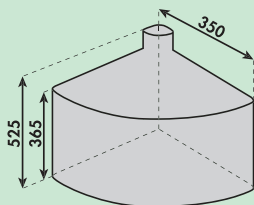

### Cabbi® junior 2

- waste capacity 18 (2 x 9) liters
- technology: swivel technology
- fitting: cabinet bottom/-wall

8013201 anthracite

121.85 €

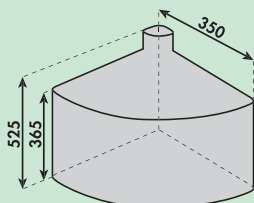

### Cabbi® junior 2 plus

Complete with bio-lid and 4 activated charcoal filters (about one year's supply).

- waste capacity 18 (2 x 9) liters
- technology: swivel technology
- fitting: cabinet bottom/-wall

8013202 anthracite

131.67 €

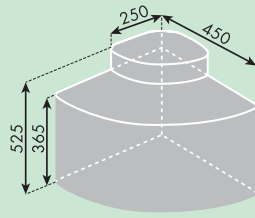

**Cabbi® 3**

- waste capacity 39 (1 x 18/1 x 9/1 x 12) liters
- technology: swivel technology
- fitting: cabinet bottom/-wall

8013171 anthracite

208.40 €

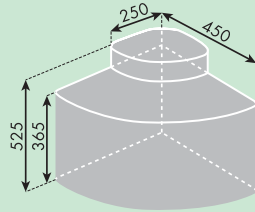

**Cabbi® 3 plus**

Complete with bio-lid and 4 activated charcoal filters (about one year's supply).

- waste capacity 39 (1 x 18/1 x 9/1 x 12) liters
- technology: swivel technology
- fitting: cabinet bottom/-wall

8013173 anthracite

211.30 €

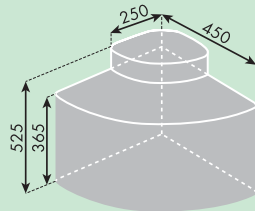

**Cabbi® 4**

- waste capacity 39 (3 x 9/1 x 12) liters
- technology: swivel technology
- fitting: cabinet bottom/-wall

8013170 anthracite

208.40 €

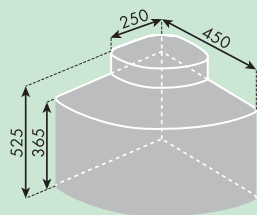

### Cabbi® 4 plus

Complete with bio-lid and 4 activated charcoal filters (about one year's supply).  
 – waste capacity 39 (3 x 9/1 x 12) liters  
 – technology: swivel technology  
 – fitting: cabinet bottom/-wall

**8013172** anthracite **211.30 €**

### Cabbi® bio-lid

Optimal accessories for Cabbi® junior 2, Cabbi® 3 and Cabbi® 4. Including 4 activated charcoal filters (assumed annual requirement).

**8011177** for 9 liters **16.39 €**



### Bio-filter retrofitting set

Replacement. For Cabbi® junior 2 plus, Cabbi® 3 plus, Cabbi® 4 plus, Cox® Base 360 S/400-2, Cox® Base 360 S/500-3, Cox® Base 360 S/600-3, Cox® Base 360 S/600-4, Cox® Base 360 K, Cox® Base 360 S/900-4, Stand-UP and Cox® Box.  
 Consisting of 4 activated charcoal filters (assumed annual requirement).

**8011178** black **7.39 €**



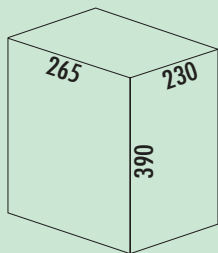

COX®beep

### Cox® Beep 400

- waste volume 10 liters
- technology: swivel technology
- lid plastic
- assembly: cabinet bottom/wall
- The cam is attached to the back of the door and is suitable for both frame and panel door mounting.
- can be used right/left

8013002 light grey, H 390 mm, 10 liters

63.28 €

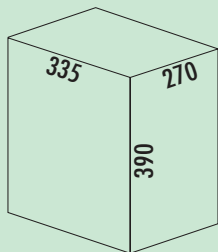

COX®beep

### Cox® Beep 450

- waste volume 15.5 liters
- technology: swivel technology
- lid plastic
- assembly: cabinet bottom/wall
- The cam is attached to the back of the door and is suitable for both frame and panel door mounting.
- can be used right/left

8013004 light grey, H 390 mm, 15.5 liters

72.10 €

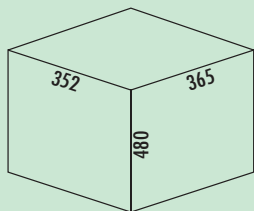

### Müllex Single 35

For a lot of rubbish in little space. Container for 35 l standard bags. Bin bag roll and pan, wiper, etc. can be stored practically on the lid. Holding rack with draw hook for swinging out – without straining the hinge fittings.

- waste capacity 35 liters
- technology: full drawer
- complete lid black
- fitting: cabinet bottom and front panel
- max. cabinet width 600 mm

**8011020** black

**129.41 €**

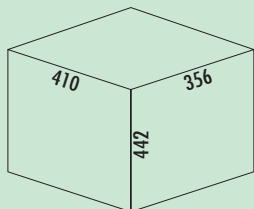

### Müllex Euro Flex

- waste capacity 35 liters
- waste container for 35-l- and 17-l-bags
- technology: swivel technology
- lid with storage recess
- arresting hook prevents strain on the hinges
- fitting cabinet wall, can be mounted left or right

**8011030** anthracite

**155.46 €**

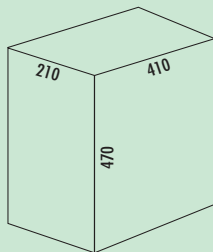

### Vario 1

- waste capacity 19 liters
- technology: swivel technology
- fitting: cabinet wall

**8011226** aluminium grey

**87.14 €**

#### Optional accessories

**8011016** Bio Boy with separating wall, grey, 5 liters

**21.60 €**

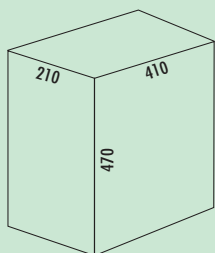
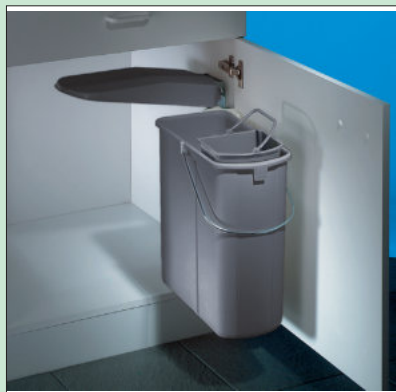

### Vario 1 plus

- waste capacity 19 liters incl. 5 l Bio Boy
- technology: swivel technology
- fitting: cabinet wall

**8011227** aluminium grey **101.51 €**

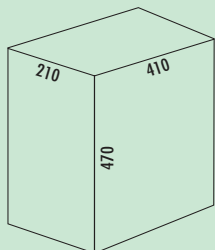

### Vario 4

- waste capacity 19 liters
- technology: swivel technology
- fitting: cabinet wall

**8011085** stainless steel **138.32 €**

#### Optional accessories

**8011016** Bio Boy with separating wall, grey, 5 liters **21.60 €**

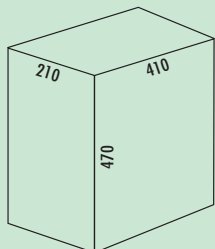

### Vario 4 plus

- waste capacity 19 liters incl. 5 l Bio Boy
- technology: swivel technology
- fitting: cabinet wall

**8011087** stainless steel **150.92 €**



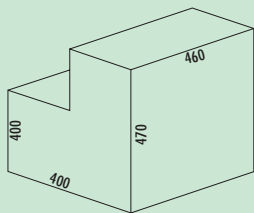

### Öko 1

- waste capacity 29 (1 x 19/1 x 10) liters
- technology: swivel technology
- fitting: cabinet wall

**8011088** aluminium grey **160.84 €**

#### Optional accessories

**8011016** Bio Boy with separating wall, grey, 5 liters **21.60 €**

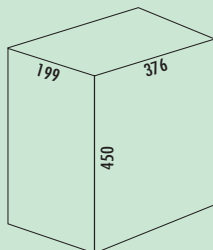

### Uno 3418

- waste capacity 18 liters
- technology: swivel technology
- fitting: cabinet wall

**8011265** white **98.82 €**

**8011267** stainless steel **116.81 €**

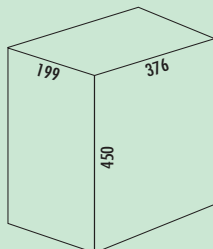

### Duo 3416

- waste capacity 16 (2 x 8) liters
- technology: swivel technology
- fitting: cabinet wall

**8011268** white **100.59 €**

**8011270** stainless steel **118.57 €**

Waste collectors

# SELECTAkit®

## Free-standing containers/waste disposal units

Extremely practical and shapely



■ Kickboy	Page 242
Pushboy	Page 242
Beta	Page 242
Alpha	Page 243
Dassa	Page 243
Evolution 100	Page 244
Model 56	Page 244

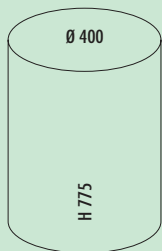

### Kickboy

Classic design supplemented by the practical pedal, which opens the flap. Body in high-grade steel sheet, flap stainless steel, insert metal.  
— waste capacity 40 liters

8012063	red	271.26 €
8012064	nickel silver	271.26 €
8012066	almond	271.26 €

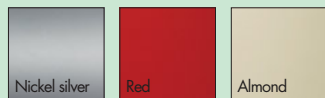
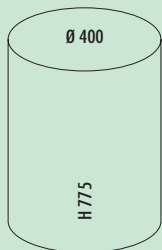

### Pushboy

This classic item is not easily left in a corner.  
— waste capacity 50 liters

8012042	nickel silver	256.05 €
8012041	red	256.05 €
8012133	almond	256.05 €

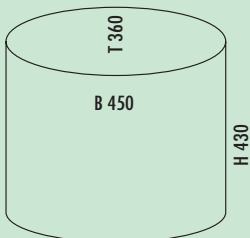

### Beta

Double waste collector with two inserts. Body made of powder-coated sheet steel and plastic insert. Lid, ring and pedal made of plastic. Perfectly shaped.  
— D 360 mm  
— waste capacity 30 (2 x 15) liters

8011080	silver	127.56 €
---------	--------	----------

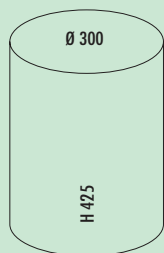

### Alpha

Pedal waste collector. Body and lid made of powder-coated sheet steel. Plastic insert, sturdy plastic bottom ring and plastic pedal.  
— waste capacity 13 liters

**8012150** nickel silver **75.80 €**

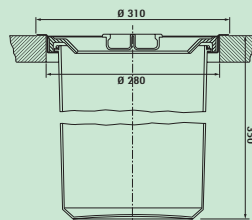

### Dassa 2

Quick and handy – installed directly in the working surface.

Also suitable for flush installation.

— installation dimension Ø 280 mm

— outside Ø 310 mm

— waste capacity 13 liters

**8011059** stainless steel with plastic insert **206.64 €**

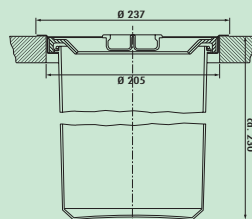

### Dassa 4

Quick and handy – installed directly in the working surface.

Also suitable for flush installation.

— installation dimension Ø 205 mm

— outside Ø 237 mm

— waste capacity 5 liters

**8011031** stainless steel with plastic insert **127.56 €**

**8011032** stainless steel with aluminium insert **167.98 €**



### Waste disposal units

- Simple, time-saving cleaning: Food residue is flushed right down the drain with the wastewater.
- Safe and simple operation: have cold water flowing, switch on the device and throw leftovers down the plughole. The disposal device liquefies the leftovers (without knives and blades), which are pressed to the grinding surface of the outside wall by centrifugal force and disintegrated into minute parts by the pressure.
- The disposal device frees the waste bucket of kitchen waste causing disagreeable odours and smeary food residues.
- Disposal of almost all kitchen waste: Even hard bones cannot damage this sturdy device.
- Maintenance-free and self-cleaning: High quality stainless steel and other durable materials. The high-performance motor was developed especially for this disposal device. The disposal device cleans itself through regular use and does not require any chemical cleaning agents.
- **Before installing the waste disposal unit, please contact the competent authorities for information on the regional legal regulations!**

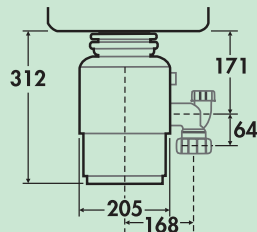

### Evolution 100

The kitchen waste disposal device may be continuously filled. Automatic change of rotational direction to extend the service life and for trouble-free use. Stainless steel grinding chamber 1 l, low-noise, with enclosed air break switch in chrome and brushed nickel, 2-way grinding process, overload switch with manual reset switch, splash-proof, GS connection, motor with 0.7 hp. Suitable for 3½" drains. **Before installing the waste disposal unit, please contact the competent authorities for information on the regional legal regulations!**

- Ø 205 mm
- weight 8.8 kg
- 40 % quieter than standard
- drill Ø for air switch 35 mm
- 520 watt, 1,400 rpm

8012031 anthracite, H 312 mm

1373.95 €

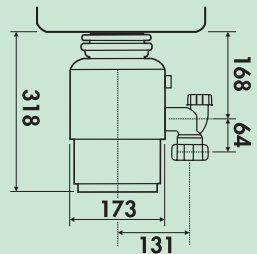

### Model 56

Kitchen waste disposer with single-stage grinding technology, can be filled continuously. Food residues are crushed into small particles and washed away in seconds. Durable and compact built-in household solution under the sink, without loss of valuable storage space. Quick Lock® mounting system for quick and easy installation. Motor with 0.55 hp, stainless steel grinding elements and integrated air switch in chrome and brushed nickel. Overload protection. Suitable for 3½" drains. **Before installing the waste disposal unit, please contact the competent authorities for information on the regional legal regulations!**

- Ø 173 mm
- weight 7.2 kg
- capacity of the grinding chamber 980 ml
- connection to the drain pipe 40 mm
- drill Ø for air switch 35 mm
- 380 watt, 1725 rpm

8012034 anthracite, H 318 mm

862.18 €