

CON-  
AKTIV®

Sockets



Emphasis

Sockets



Indispensable for the working area in the kitchen: the individual power supply. CON-AKTIV® offers switch and socket units that are absolutely dependable in function and attractive in design. Within easy reach for toasters, kettles, food processors or whatever else needs electricity.

Whether planning a new kitchen or retrofitting an existing one – CON-AKTIV® has all the solutions. The range of retractable, wall-mounted or surface-mounted switch and socket variants in brushed stainless steel, glass and matt aluminium leaves plenty of scope for the optimum socket configuration.

Single or double USB chargers supply smartphone, tablet and co. with the right energy in situ. And with some models, integrated switches even control the LED kitchen lighting.

# CON-AKTIV®

## Sockets

Safe, flexible and  
easy to install



■ CON-AKTIV®  
Surface mounted, corner sockets  
Shapely problem solvers Page 405–418

■ CON-AKTIV®  
Retracting sockets  
Ready to use in a jiffy Page 419–426

■ CON-AKTIV®  
Flush mounted sockets  
Perfectly integrated Page 427–444



# CON-AKTIV®

## Surface mounted, corner sockets

Shapely problem solvers



■ Mira Quad glass-USB A	Page 406
Mira corner glass	Page 406
Mira corner glass USB A	Page 407
Mira glass USB A	Page 407
Mira ES1	Page 408
Mira corner	Page 409
Mira corner small S	Page 410
Mira ES2/ES3/ES4	Page 410
Mira triangle	Page 410
Mira wall	Page 411
Casia 2K	Page 412
Casia 2L	Page 412
Mira ES5	Page 412
Corner double socket	Page 412
Mira WA1	Page 413
Mira BS1	Page 413
Mira ES1 with cover	Page 413
Mira KST1	Page 413
Evoline® Dock	Page 414
Evoline® Wing	Page 415
Muzak column	Page 416
Double electrical box	Page 416
Corner box 3	Page 417



### Mira glass

High-quality, functional and flexible. The socket elements of the series Mira Glass set new standards in design, materials and equipment. Fine brushed stainless steel, combined with white or black printed glass surfaces integrate themselves between the worktop and wall cabinet in any modern kitchen, even in case of subsequent electrification. Optionally equipped with earthing contact sockets and USB charger, they meet today's requirements in terms of design and function.

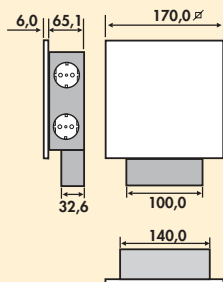

### Mira Quad glass USB A



Socket element. 3-fold. With double USB charger (base station). Front in printed and scratch-resistant glass.

- stainless steel housing
- 230 V/16 A
- 2 x USB charger type A, 5 VDC, 1A/1 out: 2 x 1050 mA
- 200 x 170 x 65.1 mm (H x W x D)
- 2000 mm mains connection line, earthing contact plug enclosed loosely
- cable outlet back below

**7053058** stainless steel/glass white **173.61 €**

**7053127** stainless steel/glass black **173.61 €**

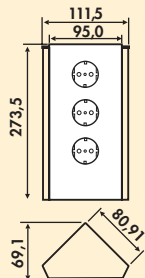

### Mira corner glass



Corner socket element, 3-fold. Front in printed and scratch-resistant glass, for 90° corner.

- stainless steel housing
- 230 V/16 A
- 273.5 x 80.91 x 80.91 mm (H x W x D)
- 2000 mm mains connection line, earthing contact plug enclosed loosely
- cable outlet back

**7053057** stainless steel/glass white **130.67 €**

**7053128** stainless steel/glass black **130.67 €**

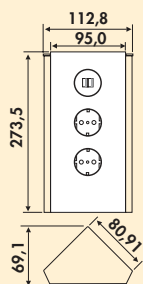

### Mira corner glass USB A



Corner socket element, 2-fold and double USB charger (charging station). Front printed and scratch-resistant glass. for 90° corner.

- stainless steel housing
- 230 V/ 16 A
- 2 x USB charger type A, 5 VDC, IA/I out: 2 x 1050 mA
- 273.5 x 80.91 x 80.91 mm (H x W x D)
- 2000 mm mains connection line, earthing contact plug enclosed loosely
- cable outlet back

**7053123** stainless steel/glass white **157.14 €**

**7053124** stainless steel/glass black **157.14 €**

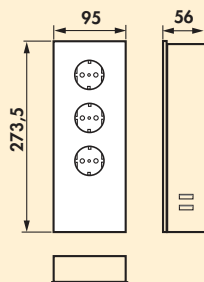

### Mira glass USB A



Socket element. 3-fold. With double USB charger (base station). Front in printed and scratch-resistant glass.

- stainless steel housing
- 230 V/16 A
- 2 x USB charger type A, 5 VDC, IA/I out: 2 x 1050 mA
- 273.5 x 95 x 56 mm (H x W x D)
- 2000 mm mains connection line, earthing contact plug enclosed loosely
- cable outlet below

**7053056** stainless steel/glass white **159.92 €**

**7053129** stainless steel/glass black **159.92 €**



### Mira ES

Elegant and contemporary in design, the Mira socket elements are truly impressive. The surfaces of the elements are easy to clean, hygienic and durable.

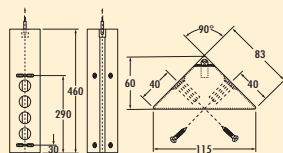

### Mira ES1



Corner socket element. 4-fold. With telescopic intermediate piece without end caps.

- 240 V/16 A
- 460–580 x 83 x 83 mm (H x W x D)
- 2000 mm mains connection line, earthing contact plug enclosed loosely
- cable outlet back top

**7053045** stainless steel **128.57 €**

**7053235** black matt **130.25 €**

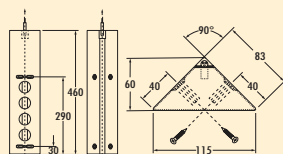

### Mira ES1 USB A/C



Corner socket element. 4-fold. With telescopic intermediate piece without end caps.

- 240 V/16 A
- 460–580 x 83 x 83 mm (H x W x D)
- 1 x USB charger type A, 5 VDC, out: 1000 mA
- 1 x USB charger type C, 5 VDC, out: 1000 mA
- 2000 mm mains connection line, earthing contact plug enclosed loosely
- cable outlet back top

**7053239** stainless steel **195.63 €**

**7053240** black matt **199.83 €**

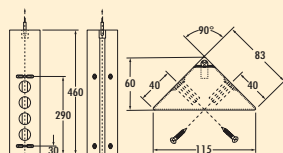

### Mira ES1-S



Corner socket element. 3-fold. With telescopic intermediate piece without end caps, with switch black, for external lighting.

- 240 V/16 A
- 460–580 x 83 x 83 mm (H x W x D)
- 2000 mm mains connection line, earthing contact plug enclosed loosely
- 1800 mm switch cable with Euro coupling
- cable outlet back top

**7053049** stainless steel **149.58 €**

**7053236** black matt **151.26 €**



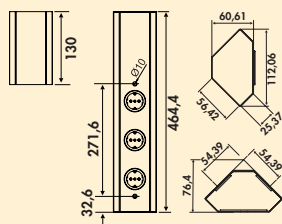

### Mira corner



Corner socket element. With telescopic intermediate piece without end caps, for 90° corner.

- stainless steel housing
- 465–595 x 81 x 81 mm (H x W x D)
- 2000 mm mains connection line, earthing contact plug enclosed loosely
- cable outlet back top

<b>7053001</b> 3-fold, without switch	<b>124.29 €</b>
<b>7053002</b> 2-fold, with switch for external illumination	<b>139.75 €</b>
<b>7053062</b> 3-fold, without switch, with Swiss sockets	<b>191.85 €</b>

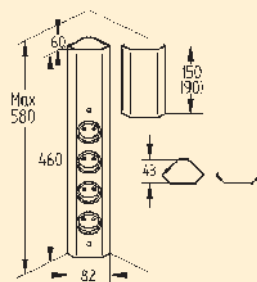

### Mira corner small 1



Socket element. 4-fold.

- housing in a compact design with telescopic intermediate piece
- 240 V/16 A
- 460–580 x 59 x 59 mm (H x W x D)
- 2000 mm mains connection line, earthing contact plug enclosed loosely
- cable outlet back top

<b>7053093</b> stainless steel	<b>122.69 €</b>
<b>7053237</b> black matt	<b>125.21 €</b>

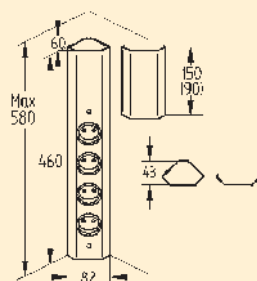

### Mira corner small USB A/C



Socket element. 4-fold.

- housing in a compact design with telescopic intermediate piece
- 240 V/16 A
- 460–580 x 59 x 59 mm (H x W x D)
- 1 x USB charger type A, 5 VDC, out: 1000 mA
- 1 x USB charger type C, 5 VDC, out: 1000 mA
- 2000 mm mains connection line, earthing contact plug enclosed loosely
- cable outlet back top

<b>7053241</b> stainless steel	<b>190.34 €</b>
<b>7053242</b> black matt	<b>194.54 €</b>

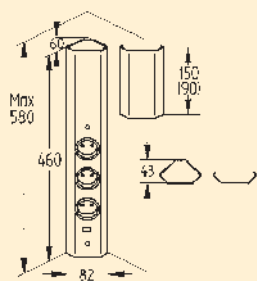

### Mira corner small USB A



Socket element. 3-fold.

- stainless steel housing in a compact design with telescopic intermediate piece
- 240 V/16 A
- 460–580 x 59 x 59 mm (H x W x D)
- 1 x USB charger type A, 5 VDC, out: 1000 mA
- 2000 mm mains connection line, earthed plug supplied loose
- cable outlet back top

<b>7053094</b> stainless steel	<b>139.50 €</b>
--------------------------------	-----------------

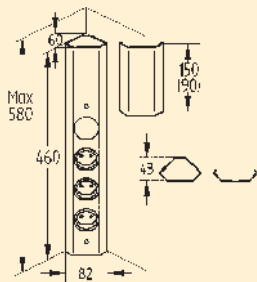

**Mira corner small S**



Socket element. 3-fold and switch for external lighting.  
 – housing in a compact design with telescopic intermediate piece  
 – 240 V/16 A  
 – 460–580 x 59 x 59 mm (H x W x D)  
 – 2000 mm mains connection line, earthed plug supplied loose  
 – 1800 mm switch cable with Euro coupling  
 – cable outlet back

7053095 stainless steel	137.82 €
7053238 black matt	142.02 €

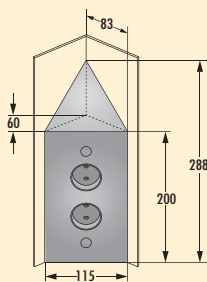

**Mira ES3**



Corner socket element. 2-fold.  
 – 240 V/16 A  
 – 288 x 83 x 83 mm (H x W x D)  
 – 2000 mm mains connection line, earthing contact plug enclosed loosely  
 – cable outlet back below

7053041 with earthed plug sockets, stainless steel	109.24 €
7053141 with earthed plug sockets, black matt	114.29 €

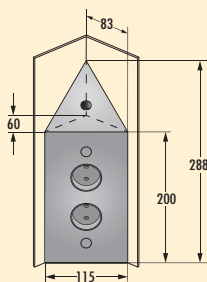

**Mira ES4**



Corner socket element. 2-fold, 240 V/16 A. 1 mini switch 240 V/2 A, for external illumination.  
 – 288 x 83 x 83 mm (H x W x D)  
 – 2000 mm mains connection line, earthing contact plug enclosed loosely  
 – 1800 mm switch cable with Euro coupling  
 – cable outlet back below

7053042 stainless steel	130.25 €
-------------------------	----------

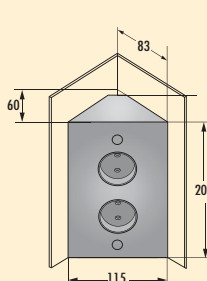

**Mira ES2**



Corner socket element. 2-fold.  
 – 240 V/16 A  
 – 200 x 83 x 83 mm (H x W x D)  
 – 2000 mm mains connection line, earthing contact plug enclosed loosely  
 – cable outlet back below

7053040 stainless steel	107.56 €
7053140 black matt	109.24 €

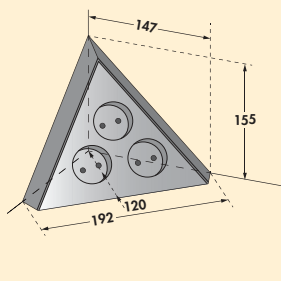
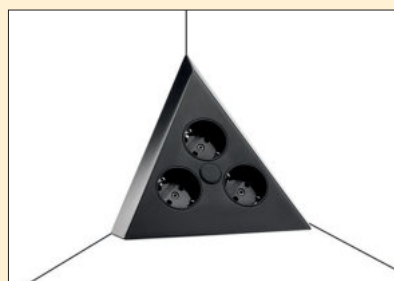

**Mira triangle**



Corner socket element. 3-fold.  
 – 240 V/16 A  
 – 155 x 147 x 147 mm (H x W x D)  
 – 2000 mm mains connection line, earthing contact plug enclosed loosely  
 – cable outlet back

7053043 stainless steel	113.45 €
7053143 black matt	117.65 €

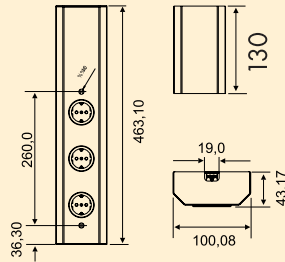

### Mira wall



Socket element. With telescopic intermediate piece without end caps.

- stainless steel housing, 230 V/16 A
- 465–595 x 100 x 43 mm (H x W x D)
- 2000 mm mains connection line, earthing contact plug enclosed loosely
- cable outlet back top

**7053004** 3-fold, without switch **127.06 €**

**7053005** 2-fold, with switch for external illumination **140.67 €**

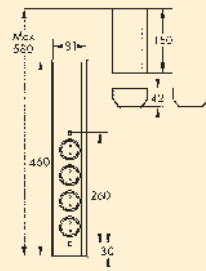

### Mira wall small



Socket element. 4-fold.

- stainless steel housing in a compact design with telescopic intermediate piece
- 240 V/16 A
- 460–580 x 81 x 42 mm (H x W x D)
- 2000 mm mains connection line, earthing contact plug enclosed loosely
- cable outlet back top

**7053090** stainless steel **125.21 €**

**7053245** black matt **134.03 €**

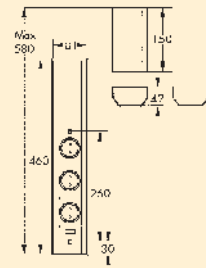

### Mira wall small USB A



Socket element. 3-fold.

- stainless steel housing in a compact design with telescopic intermediate piece
- 240 V/16 A
- 1 x USB charger type A, 5 VDC, IA/ I out: 1000 mA
- 460–580 x 81 x 42 mm (H x W x D)
- 2000 mm mains connection line, earthed plug supplied loose
- cable outlet back top

**7053091** stainless steel **138.66 €**

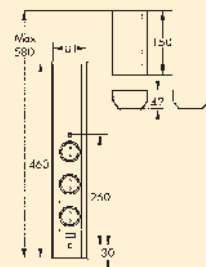

### Mira wall small USB A/C



Socket element. 3-fold.

- stainless steel housing in a compact design with telescopic intermediate piece
- 240 V/16 A
- 1 x USB charger type A, 5 VDC, IA/ I out: 1000 mA
- 1 x USB charger type C, 5 VDC, IA/ I out: 1000 mA
- 460–580 x 81 x 42 mm (H x W x D)
- 2000 mm mains connection line, earthed plug supplied loose
- cable outlet back top

**7053243** stainless steel **188.66 €**

**7053244** black matt **192.02 €**

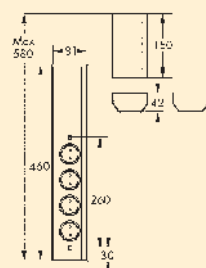

### Mira wall small S



Socket element. 3-fold and switch for external lighting.

- stainless steel housing in a compact design with telescopic intermediate piece
- 240 V/16 A
- 460–580 x 81 x 42 mm (H x W x D)
- 2000 mm mains connection line, earthed plug supplied loose
- 1800 mm switch cable with Euro coupling
- cable outlet back top

**7053092** stainless steel **134.45 €**

**7053246** black matt **153.78 €**

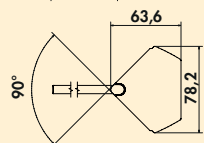
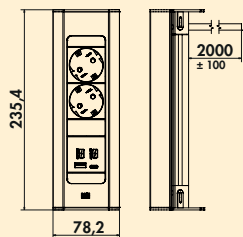

### Casia 2K power strip USB A+C



Corner socket element, aluminium. 2-fold. Suitable for vertical and horizontal mounting.

- 240 V/16 A
- 1 x USB charger type A, 5 VDC, IA/I out: 1100 mA
- 1 x USB charger type C, 5 VDC, IA/I out: 1100 mA
- 235 x 78 x 64 mm (H x W x D)
- 2000 mm mains connection line, earthing contact plug enclosed loosely
- cable outlet back

7053247 stainless steel coloured 240.34 €

7053248 black matt 240.34 €

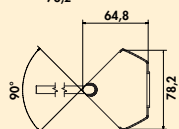
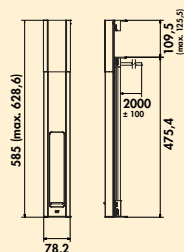

### Casia 2L power strip USB A+C



Corner socket element, aluminium. 3-fold. Suitable for vertical and horizontal mounting. With telescopic compensation piece and coverable sockets.

- 240 V/16 A
- 1 x USB charger type A, 5 VDC, IA/I out: 1100 mA
- 1 x USB charger type C, 5 VDC, IA/I out: 1100 mA
- 475 x 78 x 64 mm (H x W x D)
- 2000 mm mains connection line, earthing contact plug enclosed loosely
- cable outlet back

7053249 stainless steel coloured 314.29 €

7053250 black matt 314.29 €

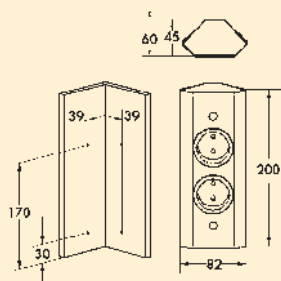

### Mira ES5



Corner socket element. 2-fold. Suitable for vertical and horizontal mounting.

- 240 V/16 A
- 200 x 59 x 59 mm (H x W x D)
- 2000 mm mains connection line, earthing contact plug enclosed loosely
- cable outlet back

7053113 stainless steel 105.04 €

7053114 black matt 107.56 €

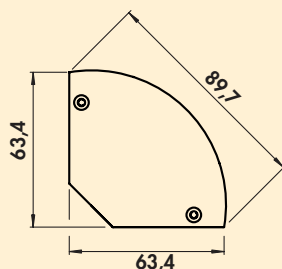

### Corner double socket



Socket element. 2-fold. Stainless steel casing with black socket inserts.

- 220–240V /16 A
- 152 x 63,4 x 63,4 mm (H x W x D)
- cable outlet in the middle
- 2000 mm mains connection line, earthing contact plug enclosed loosely

7031220 stainless steel coloured 86.55 €

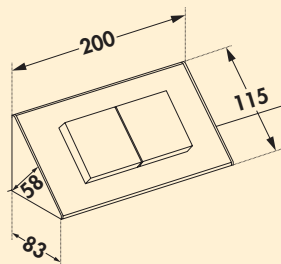

### Mira WA1



Socket element. 2-fold. With flip lid.  
 – 240 V/16 A  
 – 200 x 83 x 83 mm (H x W x D)  
 – 2000 mm mains connection line, earthing contact plug enclosed loosely  
 – cable outlet back

7053048 stainless steel

113.45 €

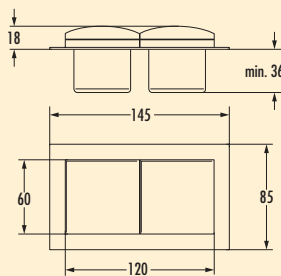

### Mira BS1



Socket element. 2-fold. With hinged lid.  
 Due to its low installation depth, the Mira BS1 is particularly suitable for integration in cabinet covers.  
 – 230 V/16 A  
 – 85 x 145 x at least 36 mm (H x W x D)  
 – 2000 mm mains connection line, earthing contact plug enclosed loosely

7053044 stainless steel

100.84 €

7053115 black matt

102.52 €

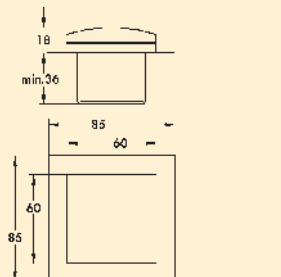

### Mira ES1 with cover



Socket element, single. With hinged lid.  
 – 240 V/16 A  
 – 2000 mm power supply cable, earthed plug loosely enclosed  
 – stainless steel cover 85 x 85 mm

7053138 stainless steel, lid stainless steel coloured

68.07 €

7053139 black matt, lid anthracite

68.07 €

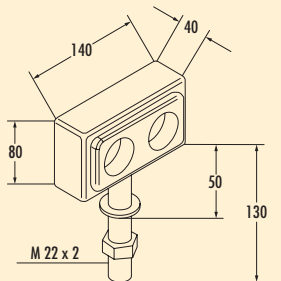

### Mira KST1



Socket element. 2-fold. For cooking islands. Edges welded and milled.  
 – 240 V/16 A  
 – drill Ø ca. 23 mm  
 – 1500 mm mains connection line without earthing contact plug  
 – cable outlet below

7053047 stainless steel

149.58 €



### Evoline® Dock Cuisine

Power supply as a design object, wherever you need it.  
Easy installation.  
Convenient, affordable and easy to clean.

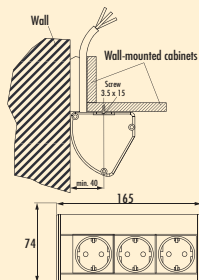

### Evoline® Dock



Socket element. 3-fold. Especially suited for installation below wall-mounted cabinets or under shelves.

- 2 x fastening elements enclosed loosely
- 74 x 165 x 75 mm (H x W x D)
- 2500 mm mains connection line, earthing contact plug enclosed loosely
- cable outlet back (below/top)

**8031133** stainless steel coloured **101.51 €**

**8031113** black matt **90.76 €**

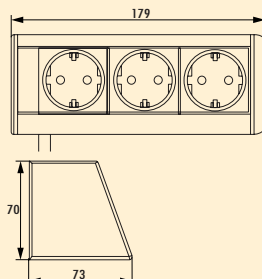

### Evoline® R Dock



Socket element. 3-fold. Especially suited for installation below wall-mounted cabinets, shelves or under the work surface.

- housing made of aluminium
- 70 x 179 x 73 mm (H x W x D)
- 2500 mm mains connection line, earthing contact plug enclosed loosely
- attachment set
- cable outlet back (below/top)

**8031146** silver coloured **92.69 €**



### Evoline® Wing

The electrical connection right in the drawer: movable and extendable furniture parts can be equipped with the Evoline® Wing cable management system. Available in the variants single socket plus charger and double socket without charger. The cable duct without socket is also available, as well as the socket element without cable duct.

The system offers individual mounting options, the cable ducting is carried out in a space-saving manner, for example behind the drawer. Cables are neither twisted nor pinched.

Product variants with cable ducting contain fastening elements for furniture parts made of wood and metal. Evoline® Wing is suitable for all types of cables such as HDMI, LAN etc., even wire cords for securing drawer pull-outs can be safely accommodated in the cable duct arm.

**Suitable for drawers from 400 mm wide and up to an pull-out length of 590 mm.**

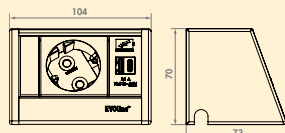

### Evoline® Wing 1 USB A+C



Socket element inc. cable routing. 1-fold. With 2-fold USB A + C charger (charging station). Mounting elements for wooden and metal furniture items are included in the scope of delivery.

- USB charger type A+C, 5 V, 2100 mA
- 2500 mm mains connection line, two-pin earthed plug supplied loose
- **Suitable for drawers from 400 mm wide and up to an pull-out length of 590 mm.**

**8031192** with earthed plug socket, silver

**243.40 €**

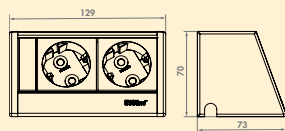

### Evoline® Wing 2



Socket element inc. cable routing. 2-fold. Mounting elements for wooden and metal furniture items are included in the scope of delivery.

- 2500 mm mains connection line, two-pin earthed plug supplied loose
- **Suitable for drawers from 400 mm wide and up to an pull-out length of 590 mm.**

**8031193** with earthed plug sockets, silver

**184.80 €**



### Evoline® Wing



Cable routing. Mounting elements for wooden and metal furniture items are included in the scope of delivery.

- L 363 mm (closed)
- D 17 mm (closed)
- **Suitable for drawers from 400 mm wide and up to an pull-out length of 590 mm.**

**8031191** without earthed plug sockets, black matt

**64.03 €**

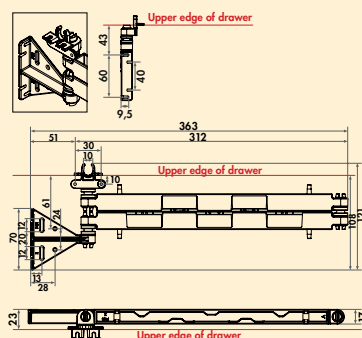

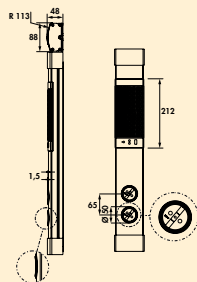

### Muzak column USB A



Socket loudspeaker combination with Bluetooth® port and USB charger (base station) for wall mounting. Simple coupling of different mobile devices such as mobile phones or tablets for music playback.

Socket element, 2-fold. With telescopic intermediate piece without end caps.

- stainless steel coloured aluminium casing with plastic end caps, 230 V/16 A
- 1 x USB charger type A, 5 VDC, 1A/1 out: 1000 mA
- 480–540 x 85 x 48 mm (H x W x D)
- 1900 mm mains connection line, earthing contact plug enclosed loosely
- cable outlet back below

8031153 with earthed plug sockets

268.57 €

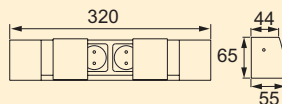

### Double electrical box



Socket element. 2-fold. With protective lid for increased safety. Convenient functional element for electrical power on the level of the worktop.

- 65 x 320 x 55 mm (H x W x D)
- with Wieland plug-in connector (without mains connection line)
- mains connection line 2 (7011134) **order separately**
- cable input right

**When installing several electrical boxes next to each other, a minimum spacing of 100 mm between the electrical boxes is to be observed.**

9015003 aluminium coloured

111.51 €

#### Optional accessories

7011134 Mains connection line 2, white, L 2000 mm

24.20 €



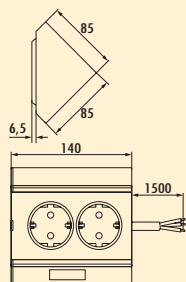

**Corner box 3**



Socket element. 2-fold.

- 140 x 85 x 85 mm (H x W x D)
- 1500 mm mains connection line without plug, 3-wire with free ends

<b>7033072</b> white	<b>56.47 €</b>
<b>7033073</b> aluminium metallic	<b>63.78 €</b>

Socket

# CON-AKTIV®

## Retracting sockets

Ready to use in a jiffy



■ Evoline® Port	Page 420
Hole saw for Evoline® Port	Page 421
Elevator	Page 422–423
Hole saw for Elevator	Page 423
Piccolino	Page 424
Hole saw for Piccolino	Page 425



### Evoline® Port

Concealed energy box for wall-mounted cabinets or worktops. Easy, guided extraction through an easy-to-press button which also guides the cable neatly when reclosing.



reddot award



### Evoline® Port 1



Energy box. Concealed. With 3 sockets for wall-mounted cabinets or worktops. Easy, guided extraction thanks to an easy-to-press button which also guides the cable neatly when reclosing.

- H 280 mm, extended H 210 mm
- 2500 mm mains connection line, earthing contact plug enclosed loosely
- drill Ø ca. 102 mm
- cable outlet below

**8031130** with earthed plug socket, lid silver coloured **146.97 €**

**8031174** with earthed plug socket, lid and profile black matt **183.53 €**

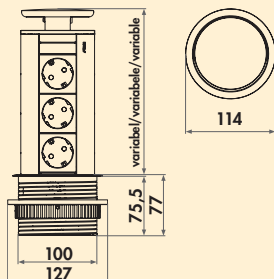

Socket

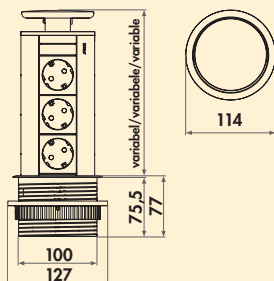

### Evoline® Port USB A



Energy box. Concealed. With 2 sockets and 1 USB charger (charging station) for wall-mounted cabinets or worktops. Easy, guided extraction thanks to an easy-to-press button which also guides the cable neatly when reclosing.

- H 250 mm, extended H 175 mm
- 1 x USB charger type A, 5 VDC, 1A/1 out: 2100 mA
- 2500 mm mains connection line with earthing contact plug
- drill Ø ca. 102 mm
- cable outlet below

**8031148** lid silver coloured **192.35 €**

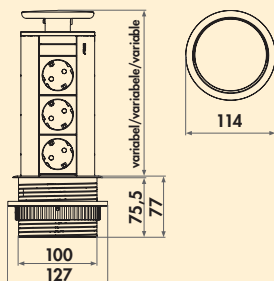

### Evoline® Port 2



Energy box. Concealed. With 3 sockets for wall-mounted cabinets or worktops. Easy, guided extraction thanks to an easy-to-press button which also guides the cable neatly when reclosing.

- H 280 mm, extended H 210 mm
- 2500 mm mains connection line, earthing contact plug enclosed loosely
- drill Ø ca. 102 mm
- cable outlet below

**8031131** with earthed plug sockets, lid stainless steel **306.13 €**



### Hole saw



- material HSS for wood/plastic
- cutting depth up to 38 mm
- with reception tool incl. centre drill

7053158 Ø 102 mm, for Evoline® Port

65.05 €



### Elevator

Socket element. Retractable. For wall cabinets or worktops. Following gentle pressure on the cover, the unit extends from a spring mechanism and offers a convenient and safe electricity supply. Simple and flush retraction when not in use.

- extends at the touch of a finger
- up to 3 sockets
- quick and easy installation
- retrofitting possible
- classic design
- USB Charger

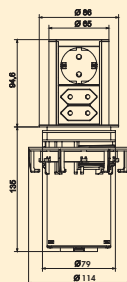

### Elevator 3



Socket element. Retractable. With 3 sockets (1 x earthing contact, 2 x Euro flat socket) for hanging cabinets or worktops.

- material plastic, black
- profile aluminium
- covers stainless steel coloured, punched and brushed
- 2000 mm mains connection line, earthing contact plug separately enclosed
- drill Ø ca. 80 mm
- for panel thickness from 16 mm to 60 mm, mounted by screw ring
- cable outlet below

7053030 stainless steel coloured

155.46 €

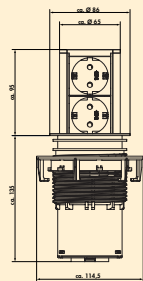

### Elevator 2



Socket element. Retractable. With 2 Schuko sockets for hanging cabinets or worktops.

- material plastic, black
- profile aluminium
- covers stainless steel coloured, punched and brushed
- 2000 mm mains connection line, Schuko plug separately enclosed
- drill Ø ca. 80 mm
- for panel thickness from 16 mm to 60 mm, mounted by screw ring
- cable outlet below

7053065 with earthed plug sockets

155.46 €

7053060 with Belgian/French sockets

163.03 €

7053064 with Swiss sockets

180.67 €

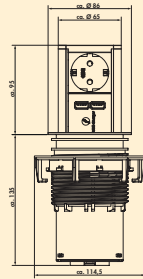

### Elevator USB A



Socket element. Retractable. With one Schuko socket and double USB charger (charging station) for hanging cabinets or worktops.

- material plastic, black
- profile aluminium
- covers stainless steel coloured, punched and brushed
- 2 x USB charger type A, 5.2 VDC, 1A/1 out: 2 x 1075 mA
- 2000 mm mains connection line, earthing contact plug separately enclosed
- drill Ø ca. 80 mm
- for panel thickness from 16 mm to 60 mm, mounted by screw ring
- cable outlet below

**7053066** stainless steel coloured

**245.38 €**



### Hole saw



- material HSS for wood/plastic
- cutting depth up to 38 mm
- with reception tool incl. centre drill

**7053053** Ø 80 mm, for Elevator

**48.11 €**



### Piccolino

Socket element. Retractable. For wall cabinets or worktops. Given light pressure on the cover, the unit slides out via a spring mechanism to provide a convenient and safe power supply. Simple and flush retraction when not in use. The Piccolino can therefore be installed **above** drawers without any problems.

**The Piccolino telescopes when closed, giving it an overall depth of less than 48 mm and is also splash-proof when closed.**

- spring-controlled pop-up mechanism at the touch of a finger
- simple and quick installation
- retrofitting possible
- very low installation depth
- flush installation possible
- IP44 when closed

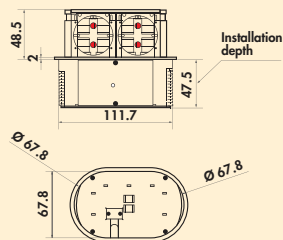

### Piccolino



Socket element. Retractable. With 2 Schuko sockets for hanging cabinets or worktops.

- material plastic, black
- Blende Edelstahl oder schwarz matt
- 2000 mm mains connection line with Schuko plug
- drill Ø ca. 68 mm
- for panel thickness from 16 mm, mounted by screw ring
- cable outlet below

7053198 cover stainless steel	121.85 €
7053199 cover black matt	130.25 €

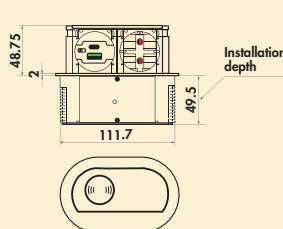

### Piccolino Qi



Socket element. Retractable. With 1 earthed socket, double USB charger A/C and Qi charging function in the lid. For installation in worktops.

- material plastic, black
- cover in stainless steel coloured glass or matt black glass
- 1 x USB charger type A, 5 VDC, IA/I out: 1100mA
- 1 x USB charger type C, 5 VDC, IA/I out: 1100mA
- 2000 mm mains connection line with earthed plug
- drill Ø ca. 68 mm
- for worktop thicknesses from 16 mm, fixing via threaded ring
- cable outlet underneath

7053201 cover in matt black glass	190.76 €
7053202 cover in stainless steel coloured glass	190.42 €





### Hole saw



- material HSS for wood/plastic
- cutting depth up to 38 mm
- with reception tool incl. centre drill

7053168 Ø 68 mm, for Piccolino

50.17 €

Socket

# CON-AKTIV®

## Flush mounted sockets

Perfectly integrated



■ Evoline® BackFlip	Page 428–429
Evoline® FlipTop Push	Page 429
Evoline® Square-USB	Page 430
Evoline® Qi	Page 431
Evoline® Circle80	Page 432
Hole saw	Page 432
PowerFit K	Page 433
Twist plug socket	Page 434
Twist 2 plug socket	Page 435
Duplex	Page 436
Hole saw	Page 437
Smile double socket	Page 438
Hole saw	Page 438
Kapsa	Page 439
Due double socket	Page 440
Pix single socket	Page 440
Hole saw	Page 440
Evoline® One	Page 441
Hole saw	Page 442
Plaza	Page 443



### Evoline® BackFlip

When closed, Evoline® BackFlip is just a thin plate on the work surface. At the touch of a finger it turns by 180 degrees and shows its useful side: USB charger and socket are high enough above the plate that they are protected from water.

The installation depth is nevertheless only 53 mm, so it can also be mounted above drawers or devices.

Equipped with new surfaces, Evoline® BackFlip is available in glas black, lacquered black and stainless steel.

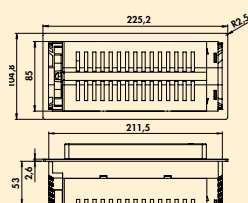

### Evoline® BackFlip USB A



Socket element. 2-fold. Rotating with USB A charger (base station).

- installation depth 53 mm
- cut-out dimensions ca. 215 x 88 mm
- 1 x USB charger type A, 5 VDC, 1A/1 out: 2100 mA
- 2500 mm mains connection line, earthing contact plug enclosed loosely
- flush-mountable
- cable outlet back left

<b>8031151</b>	with earthed plug sockets, flush-mount H 2,6 mm, stainless steel	<b>166.55 €</b>
<b>8031164</b>	with earthed plug sockets, flush-mount H 2,6 mm, painted black	<b>266.30 €</b>
<b>8031165</b>	with earthed plug sockets, flush-mount H 5 mm, glass black	<b>351.85 €</b>

<b>8031154</b>	with Belgian/French sockets, flush-mount H 2,6 mm, stainless steel	<b>198.66 €</b>
<b>8031167</b>	with Belgian/French sockets, flush-mount H 2,6 mm, painted black	<b>314.45 €</b>

<b>8031156</b>	with Swiss sockets, flush-mount H 2,6 mm, stainless steel	<b>198.66 €</b>
<b>8031166</b>	with Swiss sockets, flush-mount H 2,6 mm, painted black	<b>314.45 €</b>



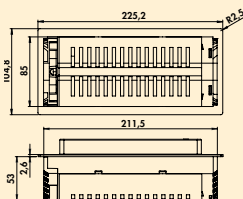

### Evoline® BackFlip USB C



Socket element. 2-fold. Rotating with USB C charger (base station).  
 – installation depth 53 mm  
 – cut-out dimensions ca. 215 x 88 mm  
 – 1 x USB charger type C, 5 VDC, 1A/1 out: 2100 mA  
 – 2500 mm mains connection line, earthing contact plug enclosed loosely  
 – flush-mountable  
 – cable outlet back left

<b>8031186</b> with earthed plug sockets, flush-mount H 2,6 mm, stainless steel	<b>184.37 €</b>
<b>8031187</b> with earthed plug sockets, flush-mount H 2,6 mm, painted black	<b>285.04 €</b>
<b>8031188</b> with earthed plug sockets, flush-mount H 5 mm, glass black	<b>369.66 €</b>



### Evoline® FlipTop Push

This socket element enables the flexible installation of sockets in the worktop (up to 50 mm thickness). The cover opens automatically at a light touch.

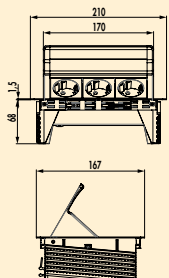

### Evoline® FlipTop Push



Socket element. 3-fold. For flush installation in the worktop (up to 50 mm thickness).  
 Lid and frame made of stainless steel.  
 – 3000 mm mains connection line with earthing contact plug  
 – installation depth 68 mm  
 – flush-mountable  
 – cable outlet back left

<b>8031160</b> with earthed plug sockets	<b>293.03 €</b>
--	-----------------



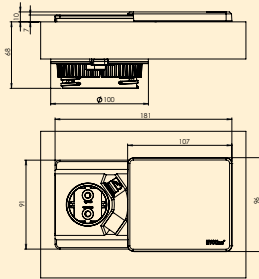

### Evoline® Square USB A



Socket element. 1-fold. With USB charger (base station). When closed, the element is almost level with the worktop. By sliding the lid the socket is exposed.

- installation depth 68 mm
- sliding lid painted stainless steel coloured
- 1 x USB charger type A, 5 VDC, IA/I out: 2100 mA
- 2500 mm mains connection line, earthing contact plugenclosed loosely
- drill Ø ca. 80 mm
- cable outlet below

8031152 with earthed plug socket

100.67 €

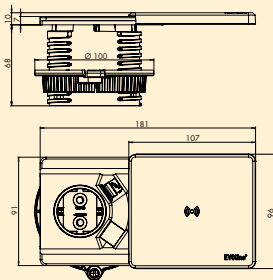

### Evoline® Square USB A Qi



Socket element. 1-fold. With USB charger (base station). When closed, the element is almost level with the worktop. By sliding the lid the socket is exposed.

- Qi inductive charging station in the lid (wireless charger). Wireless charging of mobile phones using the Qi standard.
- installation depth 68 mm
- sliding lid painted stainless steel coloured
- 1 x USB charger type A, 5 VDC, IA/I out: 2100 mA
- 2500 mm mains connection line, earthing contact plugenclosed loosely
- drill Ø ca. 80 mm
- cable outlet below

8031158 with earthed plug socket

274.37 €



### Evoline® Qi Wireless Charger

With the Evoline® Qi Wireless Charger, Qi-enabled devices can be charged without cable and other accessories. The device to be charged is simply placed on the corresponding area of the worktop – minimalism pure.

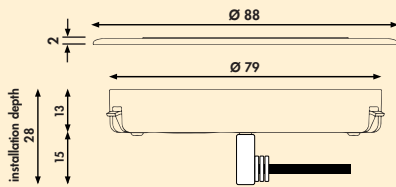
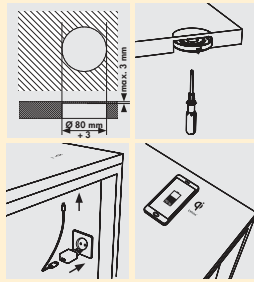

### Evoline® Qi Wireless Charger



Charging coil. Installation unit Ø 80 mm with a Qi wireless coil. Mains connection cable with EU adapter. For integration in the table top or for installation in table openings Ø 80 mm.

- the device is certified in accordance with WPC standard 1.2.2 Qi
- operating voltage 5 V
- charging power max. 10 W
- external power supply wall plug transformer 230 V
- 1500 mm supply line
- with invisible installation plate thickness max. 3 mm
- installation without cover

8031175 black matt

194.20 €

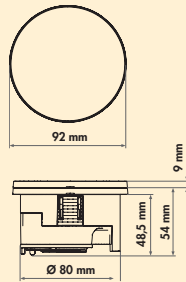

### Evoline® Circle80 Hide



Socket element. With USB charger (charging station). When closed, the element is almost flush with the worktop. By turning the lid, the socket and the USB charger are exposed.

- installation depth 48.5 mm
- rotating lid black
- double USB charger type A+C, 5 V, 2,1 A
- 2500 mm mains connection line, earthing contact plug enclosed loose
- drill Ø ca. 80 mm
- board thickness from 10 mm
- without lid, flush installation is possible
- cable outlet below

8031114 with earthed plug socket, USB A/C

154.62 €

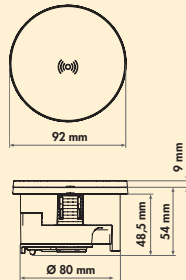

### Evoline® Circle80 DisQ



Socket element. With USB charger (charging station). When closed, the element is almost flush with the worktop. By turning the lid, the socket and the USB charger are exposed.

- Qi inductive charging station in the lid (wireless charger). Wireless charging of mobile phones based on the Qi standard with a maximum of 15 watts and magnetic function.
- external power supply plug for Qi charging function enclosed loose, for which an additional socket is required
- installation depth 48.5 mm
- rotating lid black
- double USB charger type A+C, 5 V, 2,1 A
- 2500 mm mains connection line, earthing contact plug enclosed loose
- drill Ø ca. 80 mm
- board thickness from 10 mm
- cable outlet below

8031115 with earthed plug socket, USB A/C

284.03 €

Socket



### Hole saw



- material HSS for wood/plastic
- cutting depth up to 38 mm
- with reception tool incl. centre drill

7053053 Ø 80 mm, for Elevator

48.11 €





### PowerFit K

The socket for insertion in the worktop incl. cable recess.  
Lid and longitudinal frame aluminium anodised.

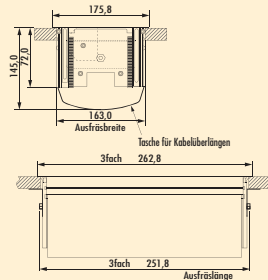

### PowerFit K



Socket element. 3-fold. Lid and longitudinal frame aluminium anodised. For flush installation in the worktop incl. cable recess.

- L 263 mm, W 176 mm
- installation depth 72 mm
- extended angle 45°
- cable 400 mm with welded plug connection
- mains connection line 2 (7011134) **order separately**
- cable outlet back left

**9015032** aluminium anodised

**152.61 €**

#### Optional accessories

**7011134** Mains connection line 2, white, L 2000 mm

**24.20 €**

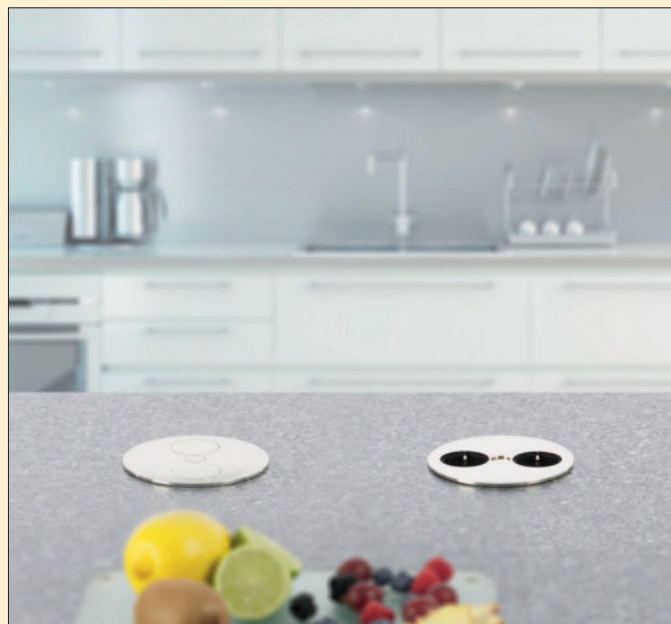

### Twist plug socket

The double socket is suitable for installation in kitchen worktops made of wood, laminate, stone or glass. Rotating the cover by 90° enables access to two earthing contact sockets that provide a convenient and stable power supply. The fixing is carried out using two mounted hexagon socket head cap screws M6 and clamping claw for or two clamping screws with hexagon socket M6. The cable can be routed downwards or sideways. 1.5 mm<sup>2</sup> black and cable end sleeves. Plastic casing with cover in nickel-plated die-cast zinc, brushed stainless steel coloured.

Since the installation depth is only 40 mm, installation above drawers is possible.

**Please observe installation instructions!**

- very low installation depth (approx. 40 mm)
- compact design (H x Ø approx. 42.5 x 115 mm)
- space-saving cable management
- simple and quick mounting
- retrofitting possible
- integrated water drainage

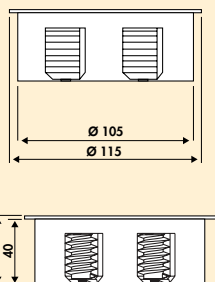

### Twist double plug socket



Socket element. 2-fold.  
 – 3680 watt/16 A, 250 VAC, IP20  
 – H05VV-F 3G1  
 – 3-pin with earthing contact  
 – 2000 mm mains connection line, earthing contact plug enclosed loosely  
 – drill Ø 105 mm, for board thicknesses from 8 mm  
 – increased contact protection  
 – cable outlet below side

<b>7053021</b> with earthed plug sockets, stainless steel coloured	<b>126.05 €</b>
<b>7053075</b> with earthed plug sockets, black matt	<b>157.98 €</b>
<b>7053076</b> with earthed plug sockets, white matt	<b>157.98 €</b>

<b>7053025</b> with Belgian/French sockets, stainless steel coloured	<b>150.42 €</b>
<b>7053085</b> with Belgian/French sockets, black matt	<b>157.14 €</b>
<b>7053086</b> with Belgian/French sockets, white matt	<b>157.14 €</b>

<b>7053059</b> with Swiss sockets, stainless steel coloured	<b>152.94 €</b>
<b>7053189</b> with Swiss sockets, black matt	<b>184.03 €</b>

Socket

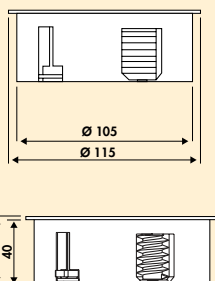

### Twist USB A



Socket element. 1-fold and double USB charger (charging station).  
 – 3680 watt/16 A, 250 VAC, IP20  
 – 2 x USB charger type A, 5 VDC, 1A/1 out: 2 x 1550 mA  
 – H05VV-F 3G1  
 – 3-pole with earthing contact  
 – 2000 mm mains connection line, with earthed plug enclosed loose  
 – drill Ø 105 mm, for plate thickness from 8 mm  
 – increased contact protection  
 – cable outlet rear side

<b>7053170</b> with earthed plug socket, stainless steel col.	<b>178.99 €</b>
<b>7053171</b> with earthed plug socket, black matt	<b>203.36 €</b>
<b>7053172</b> with earthed plug socket, white matt	<b>203.36 €</b>

<b>7053173</b> with Belgian/French socket, stainless steel coloured	<b>178.99 €</b>
<b>7053174</b> with Belgian/French socket, black matt	<b>203.36 €</b>
<b>7053175</b> with Belgian/French socket, white matt	<b>203.36 €</b>



### Twist 2 plug socket

With its rounded corners, the high-quality square design variant of the Twist double socket blends harmoniously into kitchen worktops made of wood, laminate, natural stone or glass. The replaceable lid makes it easy to clean.

The automatic and cushioned opening of the slightly recessed cover allows convenient access to two earthed sockets or an additional USB A/C charger with quick-charging function.

Fixation via two clamping claws. Cable routing can be downwards or to the side. Plastic housing with replaceable cover made of die-cast zinc. As the installation depth is only approx. 40 mm, it can easily be installed above drawers.

- very low installation depth (approx. 40 mm)
- pre-mounted for plate thickness 25–40 mm
- by changing the fastening plates also for plate thickness 6–24 mm
- space-saving cable routing
- retrofitting possible, quick and easy installation
- **removable lid for cleaning or subsequent replacement**
- **automatically cushioned opening mechanism**
- integrated water outlet

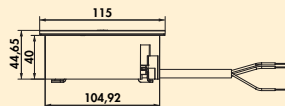
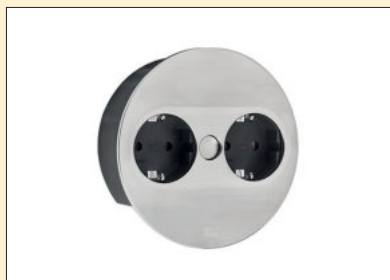

### Twist 2 double plug socket



Socket element. 2-fold.

- 3680 watt/16 A, 250 VAC, IP20
- H05VV-F 3G1
- 3-pin with earthing contact
- with earthed plug sockets
- 2000 mm mains connection line, earthing contact plug enclosed loosely
- drill Ø 105 mm, for board thicknesses from 6–40 mm
- increased contact protection
- anti-fingerprint coating
- cable outlet below side

**7053190** round, Ø 115, D ca. 45 mm, stainless steel coloured **210.08 €**

**7053191** square, L 115, B 115, D ca. 45 mm, stainless steel coloured **210.08 €**

**7053194** round, Ø 115, D ca. 45 mm, black matt **277.31 €**

**7053195** square, L 115, B 115, D ca. 45 mm, black matt **277.31 €**

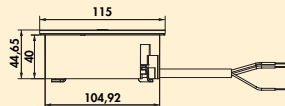
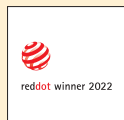

### Twist 2 USB A+C



Socket element. 1-fold and double USB charger A+C (charging station).

- 3680 watt/16 A, 250 VAC, IP20
- 1 x USB charger type A, 5 VDC, IA/I out: 1 x 3000 mA
- 1 x USB charger type C
- 3-pole with earthing contact
- 2000 mm mains connection line, with earthed plug enclosed loose
- drill Ø 105 mm, for plate thickness from 6–40 mm
- dimensions: round (H x W Ø 45 x 115 mm), square (H x W x L approx. 45 x 115 x 115 mm)
- increased contact protection
- anti-fingerprint coating
- cable outlet rear side

**7053192** round, with earthed plug socket, stainless steel coloured **330.25 €**

**7053193** square, with earthed plug socket, stainless steel coloured **330.25 €**

**7053196** round, with earthed plug socket, black matt **397.48 €**

**7053197** square, with earthed plug socket, black matt **397.48 €**





### Duplex

The built-in socket is made for use in almost all known kitchen worktops. It opens and closes simply – at the touch of a button. Both the fixed cover and the opening inner element are made of stainless steel.

Extremely simple installation – working from above with the Duplex built-in socket open, it is screwed or glued to the worktop with silicone using two clamping claws.

Since the installation depth is only approx. 48 mm, installation via drawers is possible without any problems.

- angular design: 118 x 118 (H x W)
- round design: Ø 118 mm

**Please follow the installation instructions!**

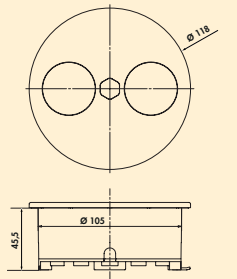
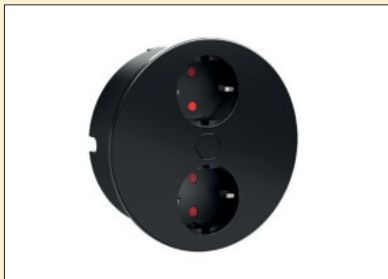
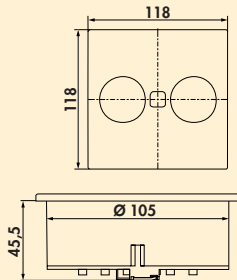
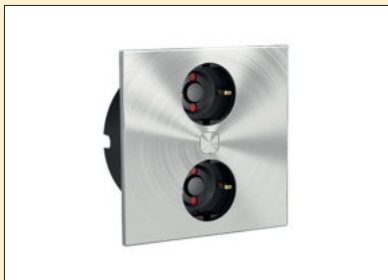

### Duplex double socket



Socket element. Double. Electric opening at the push of a button.

- 3680 watt/16 A, 250 VAC, IP20
- H05VV-F 3G 1.5 mm<sup>2</sup>
- 3-pole with earthing contact
- 2000 mm mains connection line with earthing contact plug
- drill Ø 105 mm
- installation depth approx. 48 mm
- increased contact protection
- space-saving cable routing (downwards or side cable outlet)
- simple and quick installation
- retrofitting possible
- integrated water drain

<b>7054003</b> square, with earthed plug sockets, stainless steel	<b>159.66 €</b>
<b>7054005</b> square, with earthed plug sockets, black matt	<b>176.47 €</b>

<b>7054001</b> round, with earthed plug sockets, stainless steel	<b>159.66 €</b>
<b>7054008</b> round, with earthed plug sockets, black matt	<b>176.47 €</b>

Socket

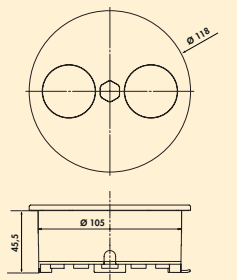
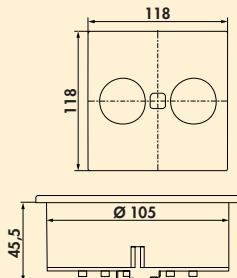

### Duplex USB A+C



Socket element. Single and double USB A+C charger (charging station).

Electric opening at the push of a button.

- 1 x USB charger type A, 5 VDC, IA/I out: 1 x 2100 mA
- 1 x USB charger type C, 5 VDC, IA/I out: 1 x 3000 mA
- 3680 watt/16 A, 250 VAC, IP20
- H05VV-F 3G 1.5 mm<sup>2</sup>
- 3-pole with earthing contact
- 2000 mm mains connection line with earthed plug
- drill Ø 105 mm
- installation depth approx. 48 mm
- increased contact protection
- space-saving cable routing (downwards or side cable outlet)
- simple and quick installation
- retrofitting possible
- integrated water drain

<b>7054004</b> square, with earthed plug socket, stainless steel	<b>213.45 €</b>
<b>7054006</b> square, with earthed plug socket, black matt	<b>229.41 €</b>

<b>7054002</b> round, with earthed plug socket, stainless steel	<b>213.45 €</b>
<b>7054007</b> round, with earthed plug socket, black matt	<b>229.41 €</b>



### Hole saw



- material HSS for wood/plastic
- cutting depth up to 38 mm
- with reception tool incl. centre drill

7053024 Ø 105 mm, for Twist and Duplex

73.46 €



### Smile double socket USB

The Smile double socket is suitable for the worktop and the rear wall. The swivelling safety glass cover glass cover (optionally in white or black) is heat-resistant and can e.g. be used as a storage space for hot pots when closed.

Since the installation depth is only approx. 40 mm, installation via drawers is possible without any problems.

**Please follow the installation instructions!**

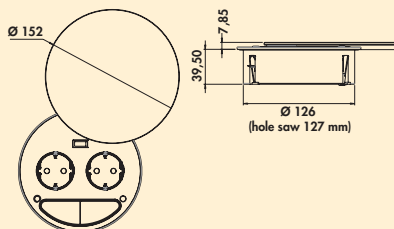

### Smile double socket USB A



Socket element. Double with USB charger (charging station) incl. storage shelf.

- plastic housing
- with round swivelling safety glass cover glass cover Ø 152 mm
- 1 x USB charger type A, 5 VDC, I/AI out: 1 x 2100 mA
- 1800 mm mains connection line, earthed plug supplied loose
- drill Ø 127 mm, for plate thicknesses from 20 mm
- installation depth approx. 40 mm
- by exchanging the enclosed clamps, also suitable for plate thicknesses from 8 mm
- increased contact protection
- cable outlet below side

**7053148** glass black

**155.29 €**

Socket



### Hole saw



- material HSS for wood/plastic
- cutting depth up to 38 mm
- with reception tool incl. centre drill

**7053149** Ø 127 mm, for Smile double socket

**79.41 €**



### Kapsa

Built-in socket element with elegant and shapely stainless steel coloured aluminium cover, which particularly protects against dust and dirt. Attachment is carried out using two mounted clamping claws for a board thickness of 30–40 mm.

- aluminium lid in high-quality look
- low installation depth (approx. 45 mm)
- retrofitting possible from above

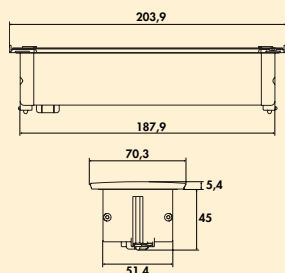

### Kapsa



Socket element. 3-fold. For installation in worktop, front panel or side wall.

- cut-out dimensions ca. 189 x 53 mm
- installation depth approx. 45 mm
- 2000 mm mains connection line, two-pin earthed plug supplied loose
- cable outlet below left

**7053068** with two-pin earthed plugs, lid stainless steel coloured 178.15 €

**7053077** with two-pin earthed plugs, lid black matt 208.40 €

**7053078** with two-pin earthed plugs, lid white 208.40 €

**7053083** with Belgian/French sockets, lid stainless steel coloured 205.88 €

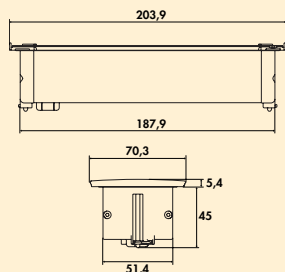

### Kapsa USB A



Socket element, 2-fold and double USB charger (charging station). For installation in worktop, front panel or side wall.

- cut-out dimensions ca. 189 x 53 mm
- installation depth approx. 45 mm
- 2 x USB charger type A, 5.2 VDC, IA/I out: 2 x 1075 mA
- 2000 mm mains connection line, two-pin earthed plug supplied loose
- cable outlet below left

**7053069** with two-pin earthed plugs, lid stainless steel coloured 208.40 €

**7053079** with two-pin earthed plugs, lid black matt 247.90 €

**7053080** with two-pin earthed plugs, lid white 247.90 €

**7053084** with Belgian/French sockets, lid stainless steel coloured 235.29 €

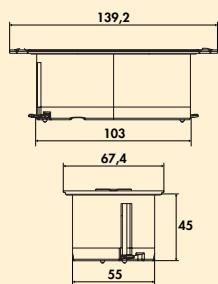

### Due double socket



Socket element. 2-fold. With sliding lid. For installation in worktop, front panel or side wall.

- drill  $\varnothing$  2 x 56 mm
- installation depth ca. 45 mm
- 2000 mm mains connection line, two-pin earthed plug supplied loose
- incl. drilling template
- lids can be opened separately
- cable outlet below centre

**7053067** with two-pin earthed plugs, stainless steel coloured **109.24 €**

**7053081** with two-pin earthed plugs, black **110.92 €**

**7053082** with two-pin earthed plugs, white **110.92 €**

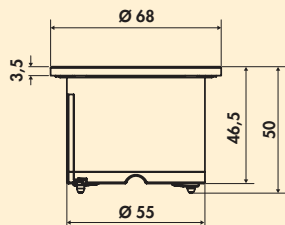
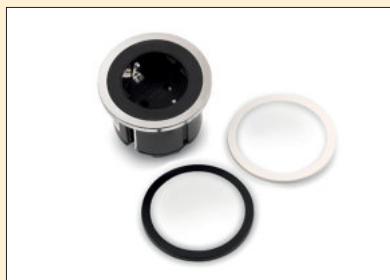

### Pix single socket



Socket element, 1-fold. Ornamental ring stainless steel coloured, black and white. For installation in worktop, front panel or side wall.

- drill  $\varnothing$  56 mm
- installation depth ca. 45 mm
- 2000 mm mains connection line, two-pin earthed plug supplied loose (permanently installed in swiss version)
- cable outlet back

**7053074** with two-pin earthed plug **72.69 €**

**7053087** with Belgian/French socket **73.11 €**

**7053088** with Swiss socket **72.52 €**

#### Optional accessories

**7053110** Lid, stainless steel coloured **23.78 €**

**7053111** Lid, black **14.37 €**

**7053112** Lid, white **14.37 €**

Socket



### Hole saw



- material HSS for wood/plastic
- cutting depth up to 38 mm
- with reception tool incl. centre drill

**7053153**  $\varnothing$  57 mm, for Pix **42.65 €**



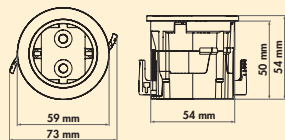

### Evoline® One single socket



Socket element, 1-fold. For installation in the worktop, front panel or side wall.

- drill Ø 54 mm
- installation depth 50 mm
- for plate thicknesses from 9 mm
- 2500 mm mains connection line, two-pin earthed plug supplied loose
- socket with contact protection
- flush mounting possible
- cable outlet on the side or bottom

7053180 ring black 78.57 €

7053181 ring brushed stainless steel 86.47 €

#### Optional accessories

7053187 Evoline® One Lid with stainless steel inlay 19.08 €

7053188 Evoline® One Complete lid black 11.01 €

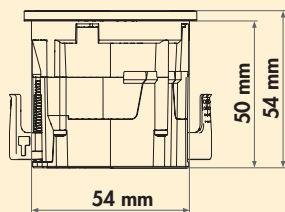

### Evoline® One double USB A+C



Socket element. Double USB charger A+C (charging station). For installation in the worktop, front panel or side wall.

- drill Ø 54 mm
- installation depth 50 mm
- for plate thicknesses from 9 mm
- USB charger type A+C, 5 V, 2.1 A
- 2500 mm mains connection line, two-pin earthed plug supplied loose
- flush mounting possible
- cable outlet on the side or bottom

7053182 ring black 141.60 €

7053183 ring brushed stainless steel 153.19 €

#### Optional accessories

7053187 Evoline® One Lid with stainless steel inlay 19.08 €

7053188 Evoline® One Complete lid black 11.01 €





### Hole saw



- material HSS for wood/plastic
- cutting depth up to 38 mm
- with reception tool incl. centre drill

7053159 Ø 54 mm, for One

41.72 €



### Plaza

The double socket element Plaza offers a variety of connection options in a flush-designed housing. The sliding double covers reveal the sockets with slight pressure. For universal installation in worktop, front panel or side wall. The sockets are splash-proof in accordance with IP54.

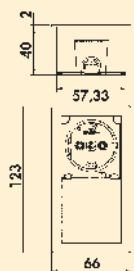

### Plaza 1



Socket element. 1-fold. Built-in socket with sliding cover.

- 3400 watts/16 A, 220–250 VAC, IP54
- 123 x 66 x 40 mm (H x W x D)
- cut-out dimensions approx. 114 x 58 mm, R 4 mm
- 2000 mm mains connection line, earthing contact plug supplied loosely
- very low installation depth (ca. 40 mm)
- increased contact protection

**7053164** brushed stainless steel **152.94 €**

**7053165** black matt **152.94 €**

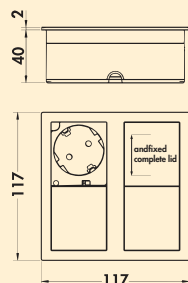

### Plaza 2



Socket element. 2-fach. Built-in socket with double sliding cover.

- 3400 watts/16 A, 220–250 VAC, IP54
- 117 x 117 x 40 mm (H x W x D)
- cut-out dimensions approx. 108 x 108 mm, R 4 mm
- 2000 mm mains connection line, earthing contact plug supplied loosely
- very low installation depth (ca. 40 mm)
- increased contact protection

**7053160** brushed stainless steel **178.15 €**

**7053161** black matt **178.15 €**

Socket