

STOREX®

Cabinet  
equipment



# Overview



Organisation systems that kitchens simply can't do without! With the clearly structured storage solutions of the STOREX® kitchen cabinet equipment, everything you need is well-organised and right at hand. In the kitchen, in the utility room, in the pantry, and even in the bathroom, the office and the workshop!

At the same time, each individual item stands for consistently secure and purposeful handling – so that things are always exactly where they should be. Drawers are used, cupboard pull-outs are opened, containers are picked up and filled. The rich spectrum of design elements offers a wealth of organised flexibility. The space available for storage is fully utilised, even hard-to-reach heights are accessed with flexible lift fittings.

STOREX® is at home wherever things need to be retrieved from or stowed in base cabinets, wall cabinets or tall cabinets. For quick and convenient organisation and separation at your fingertips!

# STOREX® Cabinet equipment

Well thought out and  
engineered



STOREX® Equipment for base units  
For space saving solutions Page 475–536

STOREX® Equipment for wall mounted  
cabinets  
Everything in its place Page 537–550

STOREX® Equipment for tall cabinets  
Convenient and easy access Page 551–564

STOREX® Accessories  
Things you always need Page 565–574





# STOREX®

## Equipment for base units

Space saving solutions



Storage systems  
Ingeniously deployed Page 477–484

Drawer inserts  
Flexible and adaptable Page 485–504

Pullouts for base units  
Exploited to the full Page 505–522

HOLDERS and hooks  
Most welcome Page 523–530

Built-in appliances for drawers  
Concealed and immediately good to go Page 531–536



# STOREX® Storage systems

Ingeniously deployed



 Cox® Box

Page 478–484

# STOREX®

## Cox® Box 220



... keeps order everywhere

### Time for new "interior views"

Everything has its place and is found straight away without hours of searching.

With the innovative Cox® Box 220 storage system, a whole variety of configurations in small and large drawers is opened up by the freely combinable containers.

They convince in every kitchen through their quick handling and the highest possible level of organised flexibility – they provide food with optimum protection during storage.

What works for the kitchen, also works for other living areas; in the bathroom and the utility room, the hygienic aspect forms a useful addition to the storage space and access options thanks to the secure lid closure. The tidy workshop displays all tools in perfect order. No more time wasted searching the summer house and garage. The Cox® Box 220 – At home anywhere!

Cox® Box 220 container system solutions, available for all standard base cabinet widths, make optimum use of the available space. Matching one-piece anti-slip mats ensure that all the containers are securely positioned. Good organisation ideas such as Cox® Box 220 not only give orientation – they also create new spaces.

The Cox® Box 220 system finds its perfect match in the Cox Work® utensils box, which fits into the 13, 16, 22 and 28 liter containers of the Cox® container system with frame size 230 x 382 mm (W x D). See catalogue 1 BASIC pages 524–526/24 EN.





### Cox® Box 220

Flexible storage solution for all standard drawers. The anti-slip mat included guarantees firm positioning on the bottom of the drawer.

- the height of the total system amounts to only 220 mm
- with coated anti-slip mats on both sides
- closing and bio lid individually deliverable

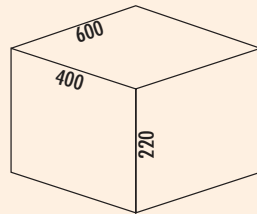

### Cox® Box 220/600-2

Collection system.

Flexible storage solution. With coated anti-slip mat.

Lid not included in scope of delivery, please order separately.

– container volume 26 (2 x 13) liters

– suitable for Cox Work® utensils box (see catalogue 1 pages 524–526/24 EN)

|         |            |         |
|---------|------------|---------|
| 8012501 | light grey | 73.35 € |
| 8013501 | anthracite | 73.35 € |

#### Optional accessories

|         |  |        |
|---------|--|--------|
| 8012342 | Closing-lid, light grey, for 13/ 16/ 22/ 28 liters | 9.41 € |
| 8013342 | Closing-lid, anthracite, for 13/ 16/ 22/ 28 liters | 9.41 € |

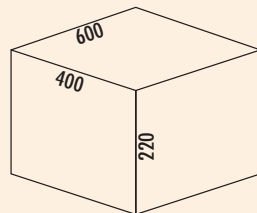
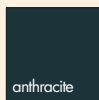
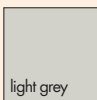

### Cox® Box 220/600-3

Collection system.

Flexible storage solution. With coated anti-slip mat.

Lid not included in scope of delivery, please order separately.

– container volume 25 (1 x 13/2 x 6) liters

– suitable for Cox Work® utensils box (see catalogue 1 pages 524–526/24 EN)

|         |            |         |
|---------|------------|---------|
| 8012500 | light grey | 89.61 € |
| 8013500 | anthracite | 89.61 € |

#### Optional accessories

|         |   |         |
|---------|---|---------|
| 8011312 | Bio-lid, light grey, for 4/ 6/ 7/ 10/ 12.5 liters     | 14.79 € |
| 8013312 | Bio-lid, anthracite, for 4/ 6/ 7/ 10/ 12.5 liters     | 14.79 € |
| 8012342 | Closing-lid, light grey, for 13/ 16/ 22/ 28 liters    | 9.41 €  |
| 8013342 | Closing-lid, anthracite, for 13/ 16/ 22/ 28 liters    | 9.41 €  |
| 8012338 | Closing-lid, light grey, for 4/ 6/ 7/ 10/ 12.5 liters | 5.97 €  |
| 8013338 | Closing-lid, anthracite, for 4/ 6/ 7/ 10/ 12.5 liters | 5.97 €  |





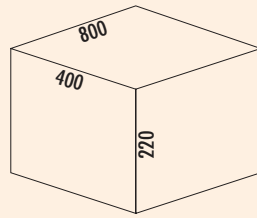

### Cox® Box 220/800-3

Collection system.  
Flexible storage solution. With coated anti-slip mat.  
Lid not included in scope of delivery, please order separately.  
— container volume 38 (1 x 18/2 x 10) liters

|         |            |          |
|---------|------------|----------|
| 8012503 | light grey | 115.88 € |
| 8013503 | anthracite | 115.88 € |

#### Optional accessories

|         |  |        |
|---------|--|--------|
| 8012341 | Closing-lid, light grey, for 10/ 12/ 16/ 21 liters | 8.74 € |
| 8013341 | Closing-lid, anthracite, for 10/ 12/ 16/ 21 liters | 8.74 € |

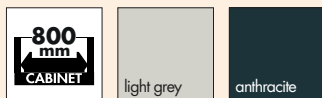
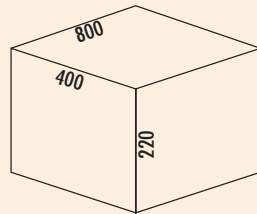

### Cox® Box 220/800-4

Collection system.  
Flexible storage solution. With coated anti-slip mat.  
Lid not included in scope of delivery, please order separately.  
— container volume 38 (2 x 13/2 x 6) liters  
— suitable for Cox Work® utensils box (see catalogue 1 pages 524–526/24 EN)

|         |            |          |
|---------|------------|----------|
| 8012502 | light grey | 131.29 € |
| 8013502 | anthracite | 131.29 € |

#### Optional accessories

|         |   |         |
|---------|---|---------|
| 8011312 | Bio-lid, light grey, for 4/ 6/ 7/ 10/ 12.5 liters     | 14.79 € |
| 8013312 | Bio-lid, anthracite, for 4/ 6/ 7/ 10/ 12.5 liters     | 14.79 € |
| 8012342 | Closing-lid, light grey, for 13/ 16/ 22/ 28 liters    | 9.41 €  |
| 8013342 | Closing-lid, anthracite, for 13/ 16/ 22/ 28 liters    | 9.41 €  |
| 8012338 | Closing-lid, light grey, for 4/ 6/ 7/ 10/ 12.5 liters | 5.97 €  |
| 8013338 | Closing-lid, anthracite, for 4/ 6/ 7/ 10/ 12.5 liters | 5.97 €  |

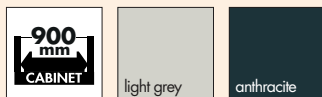
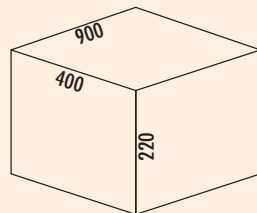

### Cox® Box 220/900-3

Collection system.  
Flexible storage solution. With coated anti-slip mat.  
Lid not included in scope of delivery, please order separately.  
— container volume 44.5 (3 x 13/1 x 5.5) liters  
— suitable for Cox Work® utensils box (see catalogue 1 pages 524–526/24 EN)

|         |            |          |
|---------|------------|----------|
| 8012505 | light grey | 142.48 € |
| 8013505 | anthracite | 142.48 € |

#### Optional accessories

|         |  |        |
|---------|--|--------|
| 8012342 | Closing-lid, light grey, for 13/ 16/ 22/ 28 liters | 9.41 € |
| 8013342 | Closing-lid, anthracite, for 13/ 16/ 22/ 28 liters | 9.41 € |

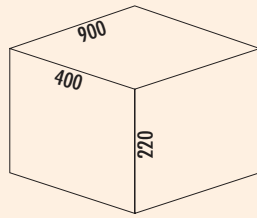

light grey

anthracite

### Cox® Box 220/900-4

Collection system.  
Flexible storage solution. With coated anti-slip mat.  
Lid not included in scope of delivery, please order separately.  
— container volume 35 (2 x 10/2 x 7.5) liters

|         |            |          |
|---------|------------|----------|
| 8012504 | light grey | 131.32 € |
| 8013504 | anthracite | 131.32 € |

#### Optional accessories

|         |  |         |
|---------|--|---------|
| 8012343 | Bio-lid, light grey, for 7.5/ 9/ 12 liters         | 16.39 € |
| 8013343 | Bio lid, anthracite, for 7.5/ 9/ 12 liters         | 16.39 € |
| 8012339 | Closing-lid, light grey, for 7.5/ 9/ 12 liters     | 8.74 €  |
| 8013339 | Closing-lid, anthracite, for 7.5/ 9/ 12 liters     | 8.74 €  |
| 8012341 | Closing-lid, light grey, for 10/ 12/ 16/ 21 liters | 8.74 €  |
| 8013341 | Closing-lid, anthracite, for 10/ 12/ 16/ 21 liters | 8.74 €  |

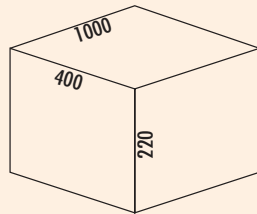

light grey

anthracite

### Cox® Box 220/1000-4

Collection system.  
Flexible storage solution. With coated anti-slip mat.  
Lid not included in scope of delivery, please order separately.  
— container volume 46 (2 x 13/2 x 10) liters  
— suitable for Cox Work® utensils box (see catalogue 1 pages 524–526/24 EN)

|         |            |          |
|---------|------------|----------|
| 8012507 | light grey | 136.72 € |
| 8013507 | anthracite | 136.72 € |

#### Optional accessories

|         |  |        |
|---------|--|--------|
| 8012342 | Closing-lid, light grey, for 13/ 16/ 22/ 28 liters | 9.41 € |
| 8013342 | Closing-lid, anthracite, for 13/ 16/ 22/ 28 liters | 9.41 € |
| 8012341 | Closing-lid, light grey, for 10/ 12/ 16/ 21 liters | 8.74 € |
| 8013341 | Closing-lid, anthracite, for 10/ 12/ 16/ 21 liters | 8.74 € |

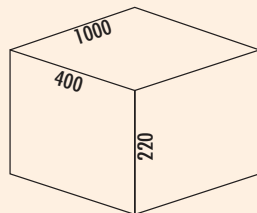

light grey

anthracite

### Cox® Box 220/1000-5

Collection system.  
Flexible storage solution. With coated anti-slip mat.  
Lid not included in scope of delivery, please order separately.  
— container volume 45 (1 x 13/2 x 10/2 x 6) liters  
— suitable for Cox Work® utensils box (see catalogue 1 pages 524–526/24 EN)

|         |            |          |
|---------|------------|----------|
| 8012506 | light grey | 158.82 € |
| 8013506 | anthracite | 158.82 € |

#### Optional accessories

|         |   |         |
|---------|---|---------|
| 8011312 | Bio-lid, light grey, for 4/ 6/ 7/ 10/ 12.5 liters     | 14.79 € |
| 8013312 | Bio-lid, anthracite, for 4/ 6/ 7/ 10/ 12.5 liters     | 14.79 € |
| 8012342 | Closing-lid, light grey, for 13/ 16/ 22/ 28 liters    | 9.41 €  |
| 8013342 | Closing-lid, anthracite, for 13/ 16/ 22/ 28 liters    | 9.41 €  |
| 8012341 | Closing-lid, light grey, for 10/ 12/ 16/ 21 liters    | 8.74 €  |
| 8013341 | Closing-lid, anthracite, for 10/ 12/ 16/ 21 liters    | 8.74 €  |
| 8012338 | Closing-lid, light grey, for 4/ 6/ 7/ 10/ 12.5 liters | 5.97 €  |
| 8013338 | Closing-lid, anthracite, for 4/ 6/ 7/ 10/ 12.5 liters | 5.97 €  |

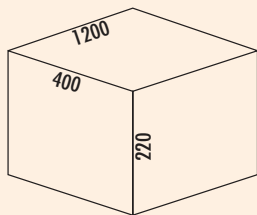

light grey

anthracite

### Cox® Box 220/1200-6

Collection system.

Flexible storage solution. With coated anti-slip mat.

Lid not included in scope of delivery, please order separately.

— container volume 58 (2 x 13/2 x 10/2 x 6) liters

— suitable for Cox Work® utensils box (see catalogue 1 pages 524–526/24 EN)

**8012508** light grey **188.10 €**

**8013508** anthracite **188.10 €**

#### Optional accessories

**8011312** Bio-lid, light grey, for 4/ 6/ 7/ 10/ 12.5 liters **14.79 €**

**8013312** Bio-lid, anthracite, for 4/ 6/ 7/ 10/ 12.5 liters **14.79 €**

**8012342** Closing-lid, light grey, for 13/ 16/ 22/ 28 liters **9.41 €**

**8013342** Closing-lid, anthracite, for 13/ 16/ 22/ 28 liters **9.41 €**

**8012341** Closing-lid, light grey, for 10/ 12/ 16/ 21 liters **8.74 €**











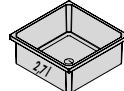

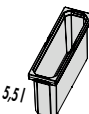

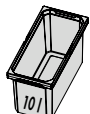

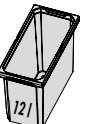
**8013341** Closing-lid, anthracite, for 10/ 12/ 16/ 21 liters **8.74 €**

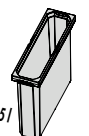
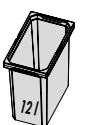
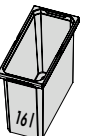
**8012338** Closing-lid, light grey, for 4/ 6/ 7/ 10/ 12.5 liters **5.97 €**

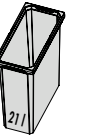
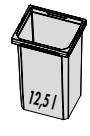
**8013338** Closing-lid, anthracite, for 4/ 6/ 7/ 10/ 12.5 liters **5.97 €**













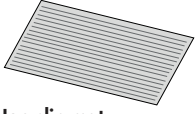

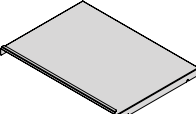

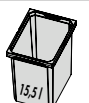

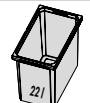
# Replacement bucket and lid overview for Cox® series

| Width mm    | 102                           | 113  | 183  | 183   | 204  | 230  |  |  |
|-------------|-------------------------------|--|--|---|--|--|--|--|
| Depth mm    | 204                           | 382  | 302  | 382   | 204  | 191  |  |  |
|             | Order no. € per pc. excl. VAT | Order no. € per pc. excl. VAT  | Order no. € per pc. excl. VAT  | Order no. € per pc. excl. VAT   | Order no. € per pc. excl. VAT  | Order no. € per pc. excl. VAT  |  |  |
| Height mm   | 82                            | <br>8013363*<br>8012363 11.51 |  |   |  | <br>8013362*<br>8012362 13.87   |  |  |
|             | 144                           |  |  |   |  | <br>8013309*<br>8012309 19.83   |  |  |
|             | 216                           |  | <br>8013325*<br>8012325 25.55   | <br>8013327*<br>8012327 30.42    | <br>8013329*<br>8012329 32.77   |  | <br>8013326*<br>8012326 26.89   |  |
|             | 256                           |  |  | <br>8012493 32.27               | <br>8013492*<br>8012492 37.31  |  | <br>8013491*<br>8012491 28.07  |  |
|             | 326                           | <br>8012332 31.60           |  | <br>8013333*<br>8012333 37.56  | <br>8013321*<br>8012321 40.25 |  | <br>8013320*<br>8012320 32.86 |  |
|             | 426                           |  |  |   | <br>8013323*<br>8012323 44.79 |  | <br>8013319<br>8012319 37.48  |  |
|             | 460                           |  |  |   |  |  |  |  |
|             | 550                           |  |  |   |  |  |  |  |
| Cealing lid |                               |  | <br>8013339*<br>8012339 8.74  | <br>8013341*<br>8012341 8.74 |  | <br>8013338*<br>8012338 5.97  |  |  |
| Bill lid    |                               |  | <br>8013343*<br>8012343 16.39 |   |  | <br>8013312*<br>8011312 14.79 |  |  |

\*anthracite

Cabinet equipment

# Replacement bucket and lid overview for Cox® series

| Width mm                  | 230   | 230   | 230   | 230  | 250   | 315   | Accessories  |
|---------------------------|---|---|---|--|---|---|--|
| Depth mm                  | 302   | 151   | 340   | 382  | 340   | 382   |  |
|                           | Order no.<br>€ per pc.<br>excl. VTA   | Order no.<br>€ per pc.<br>excl. VTA   | Order no.<br>€ per pc.<br>excl. VTA   | Order no.<br>€ per pc.<br>excl. VTA  | Order no.<br>€ per pc.<br>excl. VTA   | Order no.<br>€ per pc.<br>excl. VTA   | Order no. € per pc.<br>excl. VAT   |
| Height mm                 | 82  |   |   |  |   |   | <br><b>Non-slip mat</b><br>up to 600 mm<br>8013352* 11.93<br>8012352 11.93  |
|                           | 144   |   |   |  |   |   | up to 1200 mm<br>8013353* 23.70<br>8012353 23.70   |
|                           | 216   | <br>8012328<br>33.19               |   |  | <br>8013330*<br>8012330<br>38.49   |   | <br><b>Complete lid</b><br>Width 400 mm<br>8013153*<br>8010153 79.75<br>Width 450 mm<br>8013154*<br>8010154 85.80 |
|                           | 256   | <br>8012494<br>37.31              |   |  | <br>8013490*<br>8012490<br>40.84  |   | Width 500 mm<br>8013145*<br>8010145 95.21<br>Width 600 mm<br>8013146*<br>8010146 98.82   |
|                           | 326   | <br>8013334*<br>8012334<br>39.66 | <br>8013495*<br>8012495<br>29.58 |  | <br>8013322*<br>8012322<br>46.55 | <br>8013335*<br>8012335<br>49.75 | Width 800 mm<br>8013356*<br>8012347 73.19<br>Width 900 mm<br>8013357*<br>8012348 78.49   |
|                           | 426   |   |   |  | <br>8013324*<br>8012324<br>48.99 |   | Width 1000 mm<br>8012349 85.46<br>Width 1200 mm<br>8012350 93.45   |
|                           | 460   |   |   |  |   | <br>8012395<br>52.02             |  |
|                           | 550   |   |   | <br>8012398<br>54.62            |   | <br>8012397<br>56.39             | Width 500 mm,<br>Depth 320 mm<br>8013345*<br>8012345 93.45<br>Width 600 mm,<br>Depth 320 mm<br>8013346*<br>8012346 95.21   |
| Sealing lid/<br>top frame | <br>8012340<br>9.41              |   |   | <br>8013342*<br>8012342<br>9.41 |   | <br>8012337<br>24.54             | Width 600 mm,<br>Depth 400 mm<br>8013351*<br>8012351 69.33   |
| Bio lid                   | <br>8013344*<br>8012344<br>16.81 | <br>8013497*<br>8012497<br>16.39 |   |  |   |   | Width 300 mm,<br>Depth 516 mm<br>8010160 74.20   |

\*anthracite

# STOREX®

## Drawer inserts

Flexible and adaptable



|   |              |
|---|--------------|
| ■ Drawer system Modify                  | Page 487–493 |
| Cutlery insert Cuisio                   | Page 494–496 |
| Tray insert Cuisio Flex                 | Page 497     |
| Cutlery insert Ordine                   | Page 498     |
| Cutlery insert Adesso                   | Page 499     |
| Further cutlery inserts                 | Page 500–501 |
| Water protection<br>and anti-slide mats | Page 502     |
| Passo Siphon protection                 | Page 503     |

# STOREX® Cutlery inserts

| Frame system         | BLUM Tandembox   | BLUM Legrabox   | Hettich ArciTech  | GRASS Nova pro   |
|----------------------|--|---|---|--|
| Manufacturers        | Nobia Group (SWE),<br>DanKitchens (AT),<br>JAKA-BKL,<br>Impuls Kitchens,<br>Alno AG,<br>Pino-Kitchens,<br>alma Kitchens,<br>Nieburg Kitchens,<br>Baufomat Kitchens, Beck-<br>mann Kitchens,<br>Schröder Kitchens,<br>rwk Built-in kitchens,<br>burger Kitchens,<br>EWE-Kitchens (AT) <sup>1</sup> ,<br>Störmer Kitchens <sup>2</sup> | Schüller Kitchens,<br>Warendorfer Kitchens<br>(Störmer Kitchens,<br>Ballerina Kitchens) | Nobilis-Werke,<br>pronorm Built-in kitchens,<br>Brigitte Kitchens,<br>Beeck Kitchens,<br>Express Kitchens,<br>Nolte | Häcker Kitchens,<br>SA Fournier (FR),<br>Leicht Kitchens,<br>Eggersmann Kitchens,<br>Bax Küchenmanufaktur,<br>SachsenKitchens,<br>Rabe & Meyer,<br>Ballerina Kitchens <sup>2</sup> ,<br>Zeyko,<br>rotpunkt |
|                      | (Nominal depth – 27 mm) x<br>(Cabinet width – 82 mm)   | (Nominal depth – 27 mm) x<br>(Cabinet width – 73 mm)                                    | (Nominal depth – 27 mm) x<br>(Nominal width – 106 mm)   | (Nominal depth – 20 mm) x<br>(Cabinet width – 90 mm)   |
| Modify               | ✓  | ✓   | ✓   | ✓<br>(with compensation strip<br>8035038)  |
| Cuisio               | ✓  | does not entirely<br>fill the drawer  | only suitable<br>for Nobilia  | ✓  |
| Ordine               | ✓  | ✓   |   | ✓  |
| Adesso 1             |  |   | ✓   |  |
| Adesso 2             | ✓  | ✓   |   | ✓  |
| Cutlery insert 1     | ✓  | ✓   |   | ✓  |
| Cutlery insert 2     | ✓  | ✓   |   | ✓  |
| Multipurpose insert  | ✓  | ✓   |   | ✓  |
| Cutlery insert 4     | ✓  |   |   |  |
| Cutlery insert 5     |  |   |   | ✓  |
| Spice jar insert     | ✓  | ✓   |   | ✓  |
| Cutlery insert Smart | ✓  | ✓   |   | ✓  |

<sup>1</sup> EWE Kitchen: uses 18 gauge sides. I.e. standard dimensions BLUM Tandembox are 4 mm too wide!

<sup>2</sup> Störmer Kitchen/Ballerina Kitchen: kitchen furniture manufacturers use various frame systems. BLUM Legrabox is for in high quality range!  
Siematic Kitchen uses GRASS VIONARO (conversion at trade fair M.O.W. 2014) – Cutlery insert dimensions correspond to BLUM Legrabox.

All specifications are non-binding, subject to change.

# STOREX®

## Modify Drawer system

### The innovation in the kitchen

The Naber Modify drawer equipment system, designed for drawers with a depth of 472 mm or 572 mm incl. depth supplement, offers a variety of employment and extension options. Thanks to the clever system with equipment elements, drawers and pull-outs can be divided as needed. This flexibility makes Modify a real all-rounder among the drawer equipment systems.

The modules made of real wood are characterised by high-quality materials and excellent workmanship, giving every drawer an individual division structure. By means of continuous horizontal movement of the different elements, for example, sections of any size can be formed, enabling individual storage of various kitchen accessories.

Thanks to the use of non-slip mats on the drawer base, it is not necessary to fully equip the drawer with inserts. Here, the system manages with a few premium manufactured components and provides functional accessories for your daily needs. It is flexible in width and solves the problem of connection to drawer frames without a vertical inner profile.

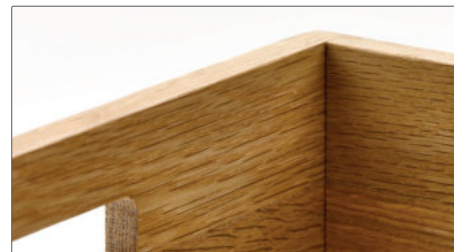

**Bright oak, varnished**



**Ash-tree black, varnished**

**Variable dividers made of powder coated metal in graphite colours**





# STOREX®

## Modify Drawer system



The innovation in the kitchen

### All the advantages at a glance:

- dominant material: solid bright oak, varnished, ash-tree black, varnished
- focus on functionality
- diverse combinations & extensions possible
- comprehensive organisation solutions
- no compensating elements necessary
- designed for drawer depth of 472 mm or 572 mm incl. depth supplement

### Components: boxes, cutlery insert, trays etc.



### Additional special elements

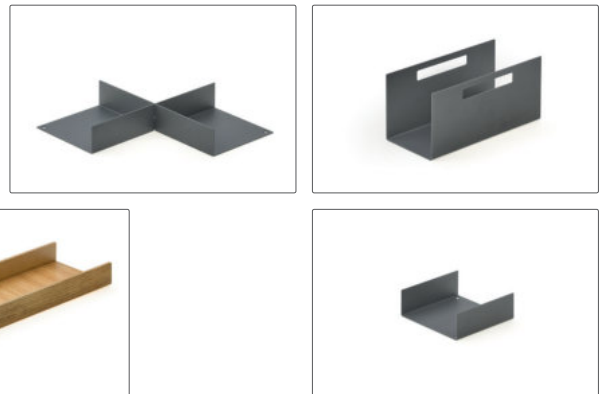

### Components and special elements in combination



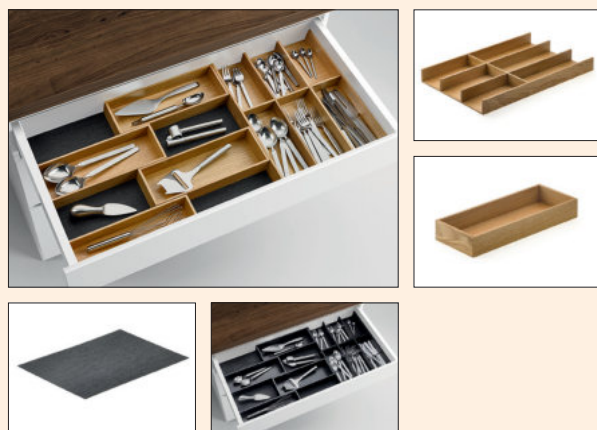

### Modify set 800/900

Suitable for 800 mm and 900 mm drawer.

Set consisting of:

- 1 Modify cutlery insert (8035021/8035121)
- 4 Modify trays (8035022/8035122)
- 1 Modify non-slip mat (8035040)

**8035050** bright oak **248.59 €**

**8035150** ash-tree black **248.59 €**



### Modify set 1000

Suitable for 1000 mm drawer.

Set consisting of:

- 1 Modify cutlery insert (8035021/8035121)
- 4 Modify trays (8035022/8035122)
- 1 Modify multifunctional insert (8035020/8035120)
- 1 Modify film holder (8035023/8035123)
- 1 Modify non-slip mat (8035040)

**8035051** bright oak **370.05 €**

**8035151** ash-tree black **370.05 €**

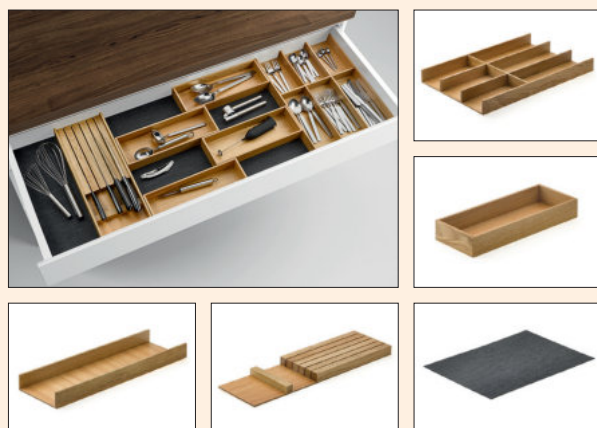

### Modify set 1200

Suitable for 1200 mm drawer.

Set consisting of:

- 1 Modify cutlery insert (8035021/8035121)
- 4 Modify trays (8035022/8035122)
- 1 Modify multifunctional insert (8035020/8035120)
- 1 Modify knife insert (8035024/8035124)
- 1 Modify non-slip mat (8035040)

**8035052** bright oak **391.52 €**

**8035152** ash-tree black **391.52 €**



### Modify cutlery insert

— 43 x 300 x 472 mm (H x W x D)

|         |                |         |
|---------|----------------|---------|
| 8035021 | bright oak     | 92.44 € |
| 8035121 | ash-tree black | 92.44 € |



### Modify depth supplement

Suitable for oversized drawers. May be cut to size.  
— 43 x 100 mm (H x D)

|         |                           |         |
|---------|---------------------------|---------|
| 8035041 | bright oak, W 600 mm      | 69.92 € |
| 8035042 | bright oak, W 1200 mm     | 94.96 € |
| 8035141 | ash-tree black, W 600 mm  | 69.92 € |
| 8035142 | ash-tree black, W 1200 mm | 94.96 € |



### Modify bowl

— 43 x 117.5 x 300 mm (H x W x D)

|         |                |         |
|---------|----------------|---------|
| 8035022 | bright oak     | 35.63 € |
| 8035122 | ash-tree black | 35.63 € |



### Modify U-divider

Metal, powder-coated. Suitable for tray (8035022).  
— 38 x 111 x 104.5 mm (H x W x D)

|         |          |         |
|---------|----------|---------|
| 8035033 | graphite | 23.53 € |
|---------|----------|---------|



### Modify multifunctional insert

Also suitable for film insert (8035023/8035123), knife insert (8035024/8035124), spice jar insert (8035025/8035125), spice inlay (8035026/8035126) and insert cross (8035027/8035127).  
— 43 x 150 x 472 mm (H x W x D)

|         |                |         |
|---------|----------------|---------|
| 8035020 | bright oak     | 48.07 € |
| 8035120 | ash-tree black | 48.07 € |



### Modify film insert

With 2 lids aluminium and intermediate piece. Without films.  
— 37.5 x 137.5 x 472 mm (H x W x D)

Multifunctional insert (8035020/8035120) order separately.

|         |                |         |
|---------|----------------|---------|
| 8035023 | bright oak     | 70.76 € |
| 8035123 | ash-tree black | 70.76 € |





### Modify knife insert

— 26 x 137.5 x 472 mm (H x W x D)

Multifunctional insert (8035020/8035120) order separately.

|                               |                |
|-------------------------------|----------------|
| <b>8035024</b> bright oak     | <b>92.44 €</b> |
| <b>8035124</b> ash-tree black | <b>92.44 €</b> |



### Modify spice jar insert

With 6 sections Ø 60 mm, without spice jars.  
— 8 x 137.5 x 472 mm (H x W x D)

Multifunctional insert (8035020/8035120) order separately.

|                               |                |
|-------------------------------|----------------|
| <b>8035025</b> bright oak     | <b>54.45 €</b> |
| <b>8035125</b> ash-tree black | <b>54.45 €</b> |



### Modify spice inlay

Slanted.  
— 26 x 137.5 x 472 mm (H x W x D)

Multifunctional insert (8035020/8035120) order separately.

|                               |                |
|-------------------------------|----------------|
| <b>8035026</b> bright oak     | <b>51.26 €</b> |
| <b>8035126</b> ash-tree black | <b>51.26 €</b> |

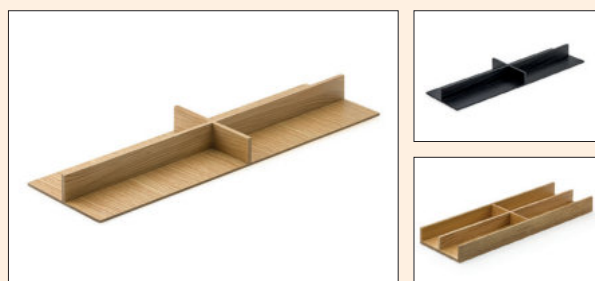

### Modify insert cross

— 37.5 x 137.5 x 472 mm (H x W x D)

Multifunctional insert (8035020/8035120) order separately.

|                               |                |
|-------------------------------|----------------|
| <b>8035027</b> bright oak     | <b>34.20 €</b> |
| <b>8035127</b> ash-tree black | <b>34.20 €</b> |

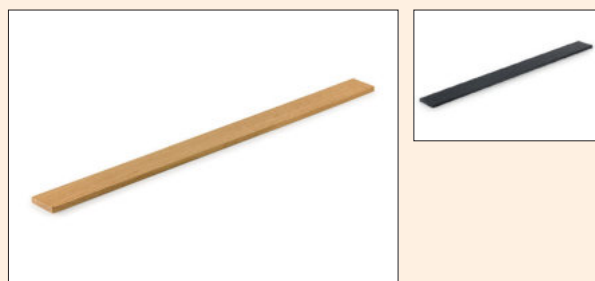

### Modify compensation strip

For deep drawers.  
— 43 x 8 mm (H x D)

|  |                |
|--|----------------|
| <b>8035038</b> up to 1200 mm cabinet, bright oak     | <b>39.92 €</b> |
| <b>8035138</b> up to 1200 mm cabinet, ash-tree black | <b>39.92 €</b> |

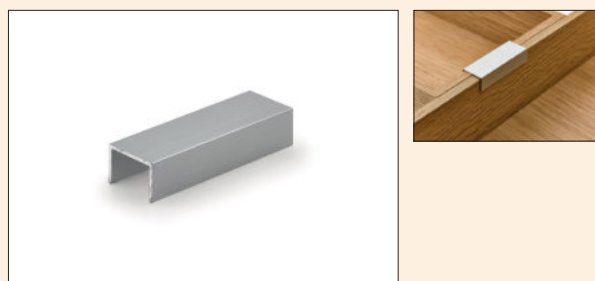

### Modify clip

For additional connection of the inserts.  
— 9 x 14 x 40 mm (H x W x D)

|                                   |               |
|-----------------------------------|---------------|
| <b>8035028</b> aluminium anodised | <b>2.86 €</b> |
|-----------------------------------|---------------|



### Modify anti-slide mat

May be cut to size. Black.

|  |                |
|--|----------------|
| <b>8035039</b> up to 600 mm cabinet, W 530, D 473 mm   | <b>10.76 €</b> |
| <b>8035040</b> up to 1200 mm cabinet, W 1130, D 473 mm | <b>20.00 €</b> |



### Modify box

Also in the pull-out, the flexible concept of Modify is consistently implemented. Horizontal sliding boxes in three sizes allow optimum use of the storage space. Due to the different dimensions of the boxes, these can, for example, be stacked to save space. Ergonomically designed handles provide for optimum handling of the boxes. Various divisions made of powder-coated metal round off the accessories range for the boxes.



### Modify box 1

– 110 x 236 x 472 mm (H x W x D)

|                               |                 |
|-------------------------------|-----------------|
| <b>8035029</b> bright oak     | <b>150.42 €</b> |
| <b>8035129</b> ash-tree black | <b>150.42 €</b> |



### Modify box 2

– 110 x 236 x 236 mm (H x W x D)

|                               |                |
|-------------------------------|----------------|
| <b>8035030</b> bright oak     | <b>95.80 €</b> |
| <b>8035130</b> ash-tree black | <b>95.80 €</b> |



### Modify U-divider with handle

Metal, powder-coated. Suitable for Box 1 (8035029/8035129) and 2 (8035030/8035130).

– 102 x 99 x 219 mm (H x W x D)

|                         |                |
|-------------------------|----------------|
| <b>8035035</b> graphite | <b>40.59 €</b> |
|-------------------------|----------------|



### Modify box 3

— 43 x 236 x 236 mm (H x W x D)

**8035031** bright oak **47.90 €**

**8035131** ash-tree black **47.90 €**

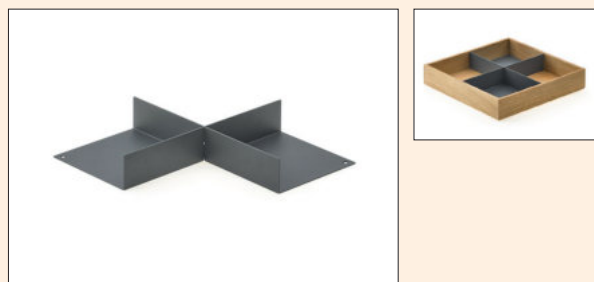

### Modify cross

Metal, powder-coated. Suitable for Box 3 (8035031/8035131).

— 38 x 223 x 223 mm (H x W x D)

**8035034** graphite **47.90 €**



### Modify box 4

— 90 x 117.5 x 300 mm (H x W x D)

**8035032** bright oak **66.81 €**

**8035132** ash-tree black **66.81 €**



### Modify anti-slide mat

May be cut to size. Black.

**8035039** up to 600 mm cabinet, W 530, D 473 mm **10.76 €**

**8035040** up to 1200 mm cabinet, W 1130, D 473 mm **20.00 €**



### Cutlery insert Cuisio

- White and graphite translucent plastic in connection with **aluminium profiles** emanate high quality.
- May be employed for all grid widths from 300 mm and for all drawer makes.
- Individual subdivision options due to flexible dividing strips.
- easy to clean
- The different widths are supplied preassembled.
- height 55 mm
- Can be used for all grid widths from 300 mm and is suitable for the ArciTech frame (Nobilia) by shortening the rear seal to the total width of the insert and thus eliminating the lateral sealing lips.

Simple assembly.

Dividing strips may be flexibly positioned and plugged onto aluminium profiles – finished!



### Cuisio 30

Cutlery insert. For 300 mm drawer width. White translucent with aluminium profile and graphite translucent with stainless-steel coloured profile. Consisting of 1 x 200 mm bowl incl. subdivisions.

- W min./max. 195/220 mm
- D min./max. 463/480 mm

**8034090** white translucent **44.87 €**

**8034215** graphite translucent **44.87 €**



### Cuisio 40

Cutlery insert. For 400 mm drawer width. White translucent with aluminium profile and graphite translucent with stainless-steel coloured profile. Consisting of 1 x 200 mm bowl and 1 x 100 mm bowl incl. subdivisions and profile.

- W min./max. 295/320 mm
- D min./max. 463/480 mm

**8034091** white translucent **64.29 €**

**8034216** graphite translucent **64.29 €**





**Cuisio 45**

Cutlery insert. For 450 mm drawer width. White translucent with aluminium profile and graphite translucent with stainless-steel coloured profile. Consisting of 1 x 200 mm bowl and 1 x 150 mm bowl, incl. subdivisions and profile.

- W min./max. 345/370 mm
- D min./max. 463/480 mm

**8034092** white translucent **67.48 €**

**8034217** graphite translucent **67.48 €**



**Cuisio 50**

Cutlery insert. For 500 mm drawer width. White translucent with aluminium profile and graphite translucent with stainless-steel coloured profile. Consisting of 1 x 200 mm bowl and 2 x 100 mm bowls, incl. subdivisions and profile.

- W min./max. 395/420 mm
- D min./max. 463/480 mm

**8034093** white translucent **85.71 €**

**8034218** graphite translucent **85.71 €**



**Cuisio 60**

Cutlery insert. For 600 mm drawer width. White translucent with aluminium profile and graphite translucent with stainless-steel coloured profile. Consisting of 1 x 600 mm insert, divided into 1 x 200 mm bowl and 2 x 150 mm bowls, incl. subdivisions and profile.

- W min./max. 495/520 mm
- D min./max. 463/480 mm

**8034094** white translucent **93.61 €**

**8034219** graphite translucent **93.61 €**



**Cuisio 80**

Cutlery insert. For 800 mm drawer width. White translucent with aluminium profile and graphite translucent with stainless-steel coloured profile. Consisting of 1 x 600 mm insert and 2 x 100 mm inserts, divided into 1 x 200 mm bowl, 2 x 150 mm bowls and 2 x 100 mm bowls incl. subdivisions and profile.

- W min./max. 695/720 mm
- D min./max. 463/480 mm

**8034095** white translucent **139.50 €**

**8034220** graphite translucent **139.50 €**



**Cuisio 90**

Cutlery insert. For 900 mm drawer width. White translucent with aluminium profile and graphite translucent with stainless-steel coloured profile. Consisting of 1 x 600 mm insert and 2 x 150 mm inserts, divided into 1 x 200 mm bowl and 4 x 150 mm bowls incl. subdivisions and profile.

- W min./max. 795/820 mm
- D min./max. 463/480 mm

**8034096** white translucent **144.03 €**

**8034221** graphite translucent **144.03 €**



**Cuisio 100**

Cutlery insert. For 1000 mm drawer width. White translucent with aluminium profile and graphite translucent with stainless-steel coloured profile. Consisting of 1 x 600 mm insert, 2 x 150 mm inserts and 1 x 100 mm insert, divided into 1 x 200 mm bowl, 4 x 150 mm bowls and 1 x 100 mm bowl incl. subdivisions and profile.

- W min./max. 895/920 mm
- D min./max. 463/480 mm

**8034097** white translucent **176.47 €**

**8034222** graphite translucent **176.47 €**



### Cuisio 120

Cutlery insert. For 1200 mm drawer width. White translucent with aluminium profile and graphite translucent with stainless-steel coloured profile.  
Consisting of 1 x 600 mm insert and 4 x 150 mm inserts, divided into 1 x 200 mm bowl and 6 x 150 mm bowls incl. subdivisions and aluminium profile.  
– W min./max. 1095/1120 mm  
– D min./max. 463/480 mm

|                                     |                 |
|-------------------------------------|-----------------|
| <b>8034098</b> white translucent    | <b>179.16 €</b> |
| <b>8034223</b> graphite translucent | <b>179.16 €</b> |



### Cuisio knife insert

Grey, consisting of two blocks.

|                                |                |
|--------------------------------|----------------|
| <b>8034059</b> for 100 mm bowl | <b>14.03 €</b> |
| <b>8034060</b> for 150 mm bowl | <b>15.71 €</b> |

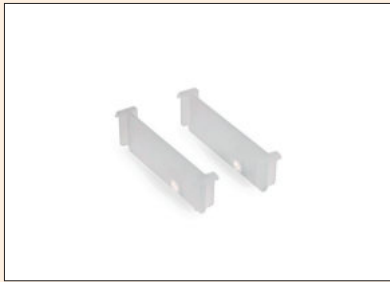

### Cuisio dividing strips/side end 2

White translucent.

|   |                |
|---|----------------|
| <b>8034114</b> dividing strips, for 100 mm bowl | <b>2.27 €</b>  |
| <b>8034115</b> dividing strips, for 150 mm bowl | <b>2.77 €</b>  |
| <b>8034116</b> dividing strips, for 200 mm bowl | <b>2.18 €</b>  |
| <b>8034117</b> side end                         | <b>14.03 €</b> |



### Cuisio dividing strips/side end 3

Graphite translucent.

|   |                |
|---|----------------|
| <b>8034227</b> dividing strips, for 100 mm bowl | <b>2.27 €</b>  |
| <b>8034228</b> dividing strips, for 150 mm bowl | <b>2.77 €</b>  |
| <b>8034229</b> dividing strips, for 200 mm bowl | <b>2.18 €</b>  |
| <b>8034230</b> side end                         | <b>14.03 €</b> |



### Cuisio 60 G

Cutlery insert with spice insert. For 600 mm drawer width. White translucent with aluminium profile and graphite translucent with stainless-steel coloured profile.  
Consisting of 1 x 200 mm bowl and 1 x 300 mm spice pot insert.  
– W min./max. 495/520 mm  
– D min./max. 463/480 mm

|                                     |                |
|-------------------------------------|----------------|
| <b>8034101</b> white translucent    | <b>96.64 €</b> |
| <b>8034106</b> graphite translucent | <b>96.64 €</b> |



### Cuisio 80 G

Cutlery insert with spice insert. For 800 mm drawer width. White translucent with aluminium profile and graphite translucent with stainless-steel coloured profile.  
Consisting of 1 x 200 mm bowl, 2 x 100 mm bowls and 1 x 300 mm spice pot insert.  
– W min./max. 695/720 mm  
– D min./max. 463/480 mm

|                                     |                 |
|-------------------------------------|-----------------|
| <b>8034102</b> white translucent    | <b>142.27 €</b> |
| <b>8034107</b> graphite translucent | <b>142.27 €</b> |

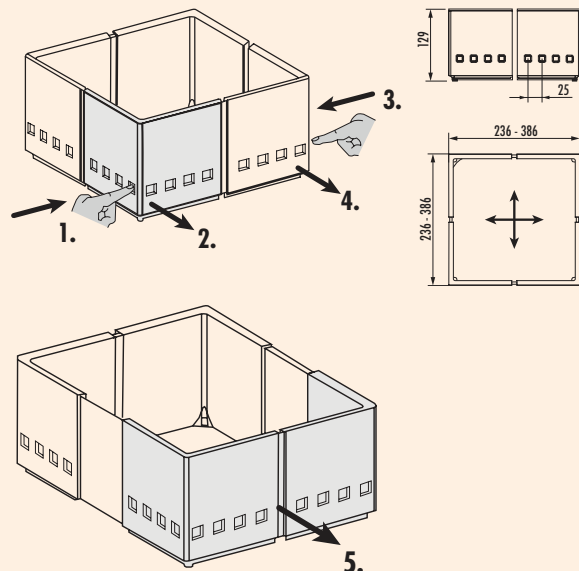

### Tray insert Cuisio Flex

Dividing strip.

- progressively adjustable in two directions
- flexible placement in the pull-out with simultaneous creation of further storage space
- Anti-slide plugs guarantee secure stand on the surface.
- only one item is required for fitting all pull-out widths, because independent of width
- corners colour-painted white and black, central part white and graphite-translucent
- **available in three set variants**

|                |  |                 |
|----------------|--|-----------------|
| <b>8034064</b> | 2-part set white translucent, corners white    | <b>114.37 €</b> |
| <b>8034065</b> | 3-part set white translucent, corners white    | <b>161.09 €</b> |
| <b>8034066</b> | 4-part set white translucent, corners white    | <b>205.21 €</b> |
| <b>8034224</b> | 2-part set graphite translucent, corners black | <b>114.37 €</b> |
| <b>8034225</b> | 3-part set graphite translucent, corners black | <b>161.09 €</b> |
| <b>8034226</b> | 4-part set graphite translucent, corners black | <b>205.21 €</b> |



### Ordine

Cutlery insert with lateral subdivision. Due to the flexible insertion of the plastic subdivision strips, different sections may be set up. Simply clip into the lateral guide groove, and slide to the desired position – finished!

Due to the lateral subdivisions, objects, e.g. knives, can no longer bump into the material at each opening.

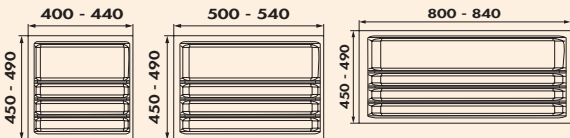
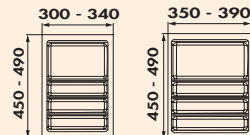

### Ordine

Cutlery insert.

- stainless-steel coloured
- edge cuttable
- H 60 mm
- min./max. widths and depths see dimension drawings
- dividing strip sets anthracite are included in the scope of delivery

|  |                |
|--|----------------|
| <b>8034210</b> for 400 mm cabinet, 1 dividing strip set  | <b>32.69 €</b> |
| <b>8034211</b> for 450 mm cabinet, 1 dividing strip set  | <b>35.04 €</b> |
| <b>8034212</b> for 500 mm cabinet, 2 dividing strip sets | <b>43.95 €</b> |
| <b>8034213</b> for 600 mm cabinet, 2 dividing strip sets | <b>51.85 €</b> |
| <b>8034214</b> for 900 mm cabinet, 3 dividing strip sets | <b>92.44 €</b> |



### Ordine dividing strip

Dividing strip set for Ordine cutlery insert.

Consisting of:

- 3 small dividers
- 1 large divider

For further divisions, this set of dividing strips can be reordered.

|                           |               |
|---------------------------|---------------|
| <b>8034175</b> anthracite | <b>8.49 €</b> |
|---------------------------|---------------|



### Ordine spice pot insert

Made of plastic and clad with stainless-steel foil.

- holes-Ø 58 mm
- 179 x 484 mm (W x D)

|   |                |
|---|----------------|
| <b>8031178</b> as of 600 mm cabinet, stainless-steel coloured | <b>18.74 €</b> |
|---|----------------|





### Cutlery insert Adesso

The design of this straightforward organizational talent is the perfect choice for today's modern kitchens. The compartment divisions with their continuous lines fit in harmoniously with the design of the rail systems.

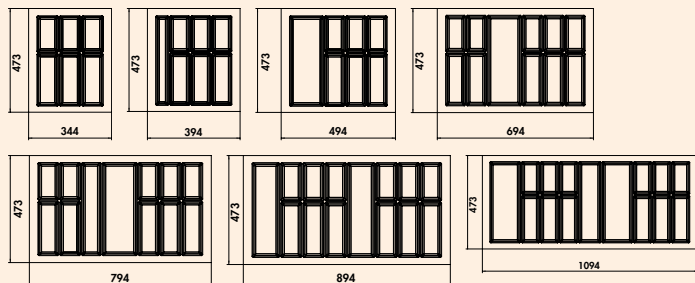
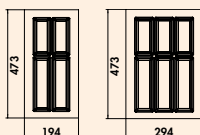

### Adesso 1

Cutlery insert suitable for Hettich ArciTech Zarge (Nobilis, Pronorm, Brigitte Kitchens, express Kitchens).

- colour grey
- widths and depths see dimension drawings
- H 50.5 mm

|                                    |                |
|------------------------------------|----------------|
| <b>8034264</b> for 300 mm cabinet  | <b>14.71 €</b> |
| <b>8034265</b> for 400 mm cabinet  | <b>15.38 €</b> |
| <b>8034266</b> for 450 mm cabinet  | <b>16.89 €</b> |
| <b>8034267</b> for 500 mm cabinet  | <b>19.16 €</b> |
| <b>8034268</b> for 600 mm cabinet  | <b>24.03 €</b> |
| <b>8034269</b> for 800 mm cabinet  | <b>29.24 €</b> |
| <b>8034270</b> for 900 mm cabinet  | <b>41.68 €</b> |
| <b>8034271</b> for 1000 mm cabinet | <b>48.49 €</b> |
| <b>8034272</b> for 1200 mm cabinet | <b>52.94 €</b> |

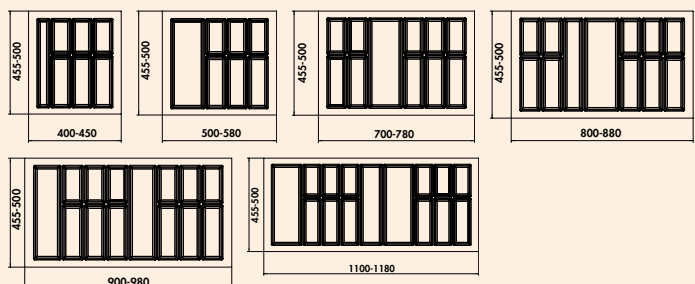

### Adesso 2

Cutlery insert.

- colour black matt
- edge cuttable
- min./max. widths and depths see dimension drawings
- H 50.5 mm

|                                    |                |
|------------------------------------|----------------|
| <b>8034274</b> for 400 mm cabinet  | <b>16.47 €</b> |
| <b>8034275</b> for 450 mm cabinet  | <b>17.23 €</b> |
| <b>8034276</b> for 500 mm cabinet  | <b>18.49 €</b> |
| <b>8034277</b> for 600 mm cabinet  | <b>21.93 €</b> |
| <b>8034278</b> for 800 mm cabinet  | <b>41.01 €</b> |
| <b>8034279</b> for 900 mm cabinet  | <b>47.39 €</b> |
| <b>8034280</b> for 1000 mm cabinet | <b>55.71 €</b> |
| <b>8034281</b> for 1200 mm cabinet | <b>70.00 €</b> |

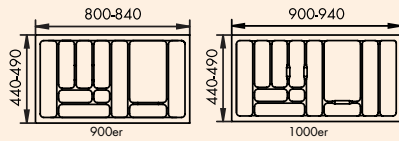
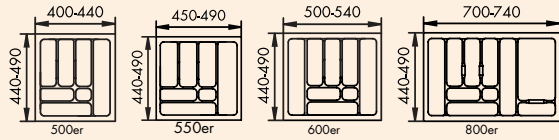
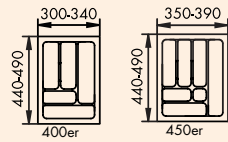

### Cutlery insert 1

- colour grey
- edge cuttable
- min./max. widths and depths see dimension drawings
- H 50 mm

|                                    |                |
|------------------------------------|----------------|
| <b>8034125</b> for 400 mm cabinet  | <b>15.13 €</b> |
| <b>8034126</b> for 450 mm cabinet  | <b>16.05 €</b> |
| <b>8034127</b> for 500 mm cabinet  | <b>17.39 €</b> |
| <b>8034128</b> for 550 mm cabinet  | <b>19.75 €</b> |
| <b>8034129</b> for 600 mm cabinet  | <b>20.92 €</b> |
| <b>8034130</b> for 800 mm cabinet  | <b>36.22 €</b> |
| <b>8034131</b> for 900 mm cabinet  | <b>42.18 €</b> |
| <b>8034132</b> for 1000 mm cabinet | <b>50.25 €</b> |

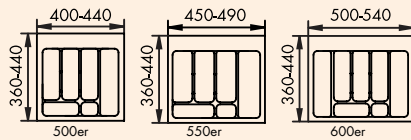
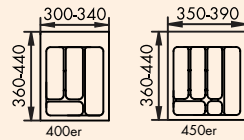

### Cutlery insert 2

- colour grey
- edge cuttable
- min./max. widths and depths see dimension drawings
- H 50 mm

|                                   |                |
|-----------------------------------|----------------|
| <b>8034120</b> for 400 mm cabinet | <b>29.75 €</b> |
| <b>8034121</b> for 450 mm cabinet | <b>30.00 €</b> |
| <b>8034122</b> for 500 mm cabinet | <b>31.85 €</b> |
| <b>8034123</b> for 550 mm cabinet | <b>35.13 €</b> |
| <b>8034124</b> for 600 mm cabinet | <b>36.39 €</b> |

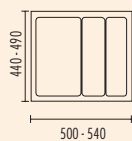
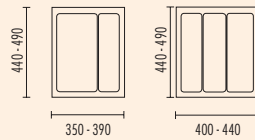

### Multi-purpose insert

Cutlery insert. For accomodating large kitchen appliances.

- colour grey
- edge cuttable
- min./max. widths and depths see dimension drawings
- H 50 mm

|                                   |                |
|-----------------------------------|----------------|
| <b>8034134</b> for 450 mm cabinet | <b>19.92 €</b> |
| <b>8034135</b> for 500 mm cabinet | <b>20.67 €</b> |
| <b>8034136</b> for 600 mm cabinet | <b>22.44 €</b> |

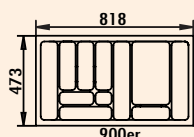
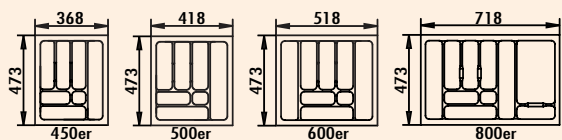
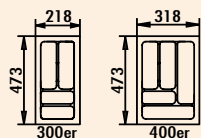

### Cutlery insert 4

Suitable for Blum Tandembox (Alno, Pino, Impuls, Beckermann Kitchens, bauformat, Störmer Kitchens, Schröder Kitchens, ewe Kitchens, rwk Einbauküchen, burger Kitchens).

- colour silver-grey
- H 50 mm

|  |                |
|--|----------------|
| <b>8030008</b> for 300 mm cabinet, W 218, D 473 mm | <b>14.29 €</b> |
| <b>8030009</b> for 400 mm cabinet, W 318, D 473 mm | <b>14.29 €</b> |
| <b>8030010</b> for 450 mm cabinet, W 368, D 473 mm | <b>15.55 €</b> |
| <b>8030011</b> for 500 mm cabinet, W 418, D 473 mm | <b>18.07 €</b> |
| <b>8030012</b> for 600 mm cabinet, W 518, D 473 mm | <b>21.76 €</b> |
| <b>8030002</b> for 800 mm cabinet, W 718, D 473 mm | <b>37.65 €</b> |
| <b>8030007</b> for 900 mm cabinet, W 818, D 473 mm | <b>45.46 €</b> |

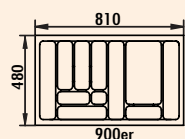
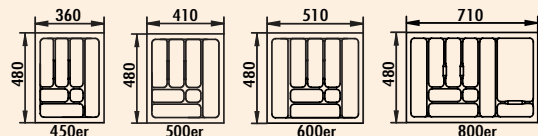
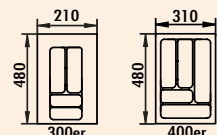

### Cutlery insert 5

Suitable for Grass Nova Pro (Leicht, Häcker, Zeyko, rotpunkt, Ballerina Kitchens, Sachsen Kitchens).

- colour silver-grey
- H 50 mm

|  |                |
|--|----------------|
| <b>8034255</b> for 300 mm cabinet, W 210, D 480 mm | <b>14.29 €</b> |
| <b>8034256</b> for 400 mm cabinet, W 310, D 480 mm | <b>14.29 €</b> |
| <b>8034257</b> for 450 mm cabinet, W 360, D 480 mm | <b>15.55 €</b> |
| <b>8034258</b> for 500 mm cabinet, W 410, D 480 mm | <b>18.07 €</b> |
| <b>8034259</b> for 600 mm cabinet, W 510, D 480 mm | <b>21.76 €</b> |
| <b>8034260</b> for 800 mm cabinet, W 710, D 480 mm | <b>37.65 €</b> |
| <b>8034261</b> for 900 mm cabinet, W 810, D 480 mm | <b>45.46 €</b> |

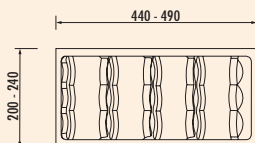

### Spice pot insert

For 300 mm drawers. For spice pots in 12-part set; small or large pots may be used. Pots are inserted aslant.

- colour silver-grey
- edge may be shortened
- H 50 mm

|                                |                |
|--------------------------------|----------------|
| <b>8034069</b> W 240, D 490 mm | <b>27.31 €</b> |
|--------------------------------|----------------|

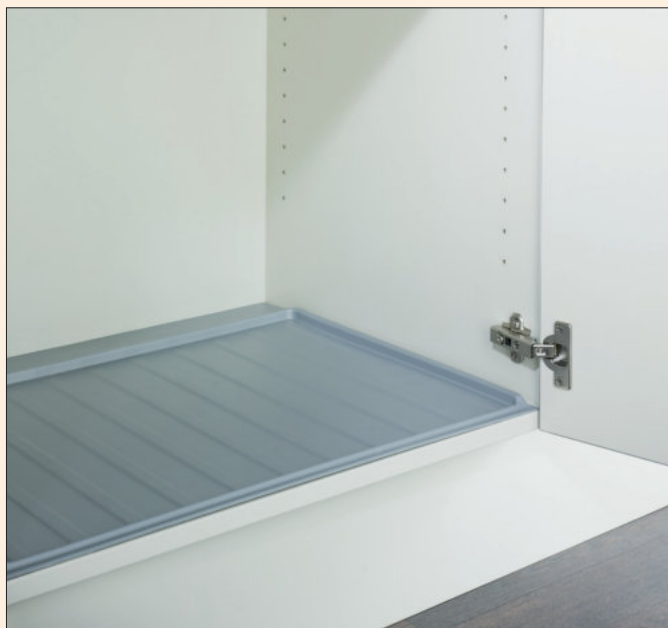

### Water protection mat Protect

- Maximum safety: Protect is a closed system which provides maximum safety in case the siphon or containers leak, and thus protects the sink body against serious damage (swelling).
- Best cleaning properties: Protect is designed so that the system can be removed from the sink body at any time for cleaning or replacement.
- Best solution for the environment: Protect is made of recyclable polystyrene.

|  |                |
|--|----------------|
| <b>8034232</b> for 500 mm cabinet, W 462, D 580 mm | <b>21.68 €</b> |
| <b>8034233</b> for 600 mm cabinet, W 562, D 580 mm | <b>23.28 €</b> |



### Anti-slide mat 1

For pull-outs and carousel plates, colour: grey. Due to the great stability, crockery and pots no longer slide. Made of high-quality synthetic rubber with rhombus pattern surface, may be easily taken out for cleaning.

|  |                |
|--|----------------|
| <b>8034014</b> for 500 mm cabinet, W 450, D 500 mm | <b>9.83 €</b>  |
| <b>8034015</b> for 600 mm cabinet, W 550, D 500 mm | <b>11.18 €</b> |
| <b>8034016</b> for 800 mm cabinet, W 750, D 500 mm | <b>17.65 €</b> |
| <b>8034017</b> for 900 mm cabinet, W 850, D 500 mm | <b>20.25 €</b> |



|  |                 |
|--|-----------------|
| <b>8034019</b> rolled good, grey, W 500 mm, 5 RM | <b>106.39 €</b> |
|--|-----------------|



### Anti-slide mat 2

For pull-outs.

- can be cut to size
- may be easily taken out for cleaning

|   |                |
|---|----------------|
| <b>8012352</b> up to 600 mm cabinets, W 500, D 480 mm, light grey   | <b>11.93 €</b> |
| <b>8012353</b> up to 1200 mm cabinets, W 1100, D 480 mm, light grey | <b>23.70 €</b> |

|  |                |
|--|----------------|
| <b>8013352</b> up to 600 mm cabinets, W 500, D 480 mm, black   | <b>11.93 €</b> |
| <b>8013353</b> up to 1200 mm cabinets, W 1100, D 480 mm, black | <b>23.70 €</b> |





### Passo siphon protection

With freely plannable washing stand cabinet bases, the siphon protection enables free use of the space under the washing stand as storage space. For this, the siphon protection optimally covers the necessary cut-out and provides optional storage space for accessories.

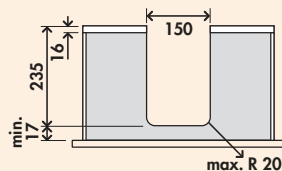
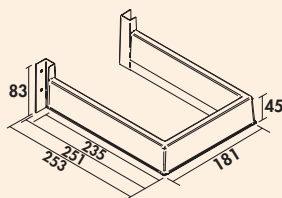

### Passo siphon protection 1

Covers the siphon cut-out, plastic.  
— 45 x 181 x 253 mm (H x W x D)

8032201 orion grey

8.32 €

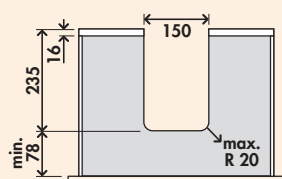
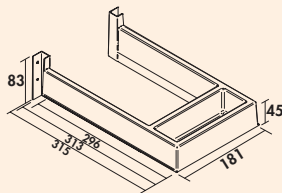

### Passo siphon protection 2

Covers the siphon cut-out, incl. storage tray, plastic.  
— 45 x 181 x 315 mm (H x W x D)

8032203 orion grey

10.34 €

Cabinet  
equipment

# STOREX®

## Pullouts for base units

Exploited to the full



|                          |              |
|--------------------------|--------------|
| ■ Cornerstone Swing      | Page 506–507 |
| ■ Cornerstone Maxx       | Page 508–509 |
| ■ VS COR Fold            | Page 510–511 |
| ■ VS COR Wheel Pro       | Page 512     |
| ■ VS SUB Slim            | Page 513–514 |
| ■ VS SUB Side            | Page 515     |
| ■ Internal pull-outs     | Page 516     |
| ■ SpaceFlexx Set         | Page 516     |
| ■ Swivel mechanics       | Page 517     |
| ■ TopFlex pull-out table | Page 518     |
| ■ Laundry pull-outs      | Page 519–521 |





### Cornerstone Swing

Cornerstone Swing moves the contents in front of the cabinet, thus opening up new perspectives. The trays are positioned well in front of the cabinet body, providing optimum accessibility. The trays can be mounted at different heights, and the lower shelf swings out automatically when the door is opened.

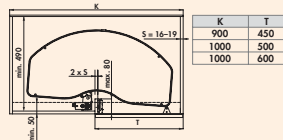

### Cornerstone Swing fitting set

Corner cupboard swivel fitting for accommodating shelves.

- for 900 mm cabinet width and 450 mm door width
- for 1000 mm cabinet width and 500 or 600 mm door width
- installation depth min. 490 mm
- telescopic up to 40 mm
- swivels out to the right or left
- swivel technology that slides straight out, no obstruction of the adjacent cabinet

#### Set consisting of:

- standpipe
- 2 x swivel arm
- pipe fixture above
- 2 x mount for shelf

#### Please note:

**Shelves need to be ordered separately!**

|                |  |                 |
|----------------|--|-----------------|
| <b>8037171</b> | installation height 610–650 mm, silver | <b>277.31 €</b> |
| <b>8037172</b> | installation height 651–690 mm, silver | <b>279.83 €</b> |
| <b>8037173</b> | installation height 691–730 mm, silver | <b>281.51 €</b> |
| <b>8037174</b> | installation height 731–770 mm, silver | <b>283.19 €</b> |

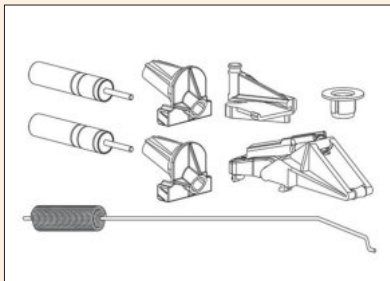

### Cornerstone Swing soft-closing set

The top shelf closes automatically and silently thanks to a self-closing mechanism with damping.

|                |      |                |
|----------------|------|----------------|
| <b>8037175</b> | grey | <b>35.29 €</b> |
|----------------|------|----------------|



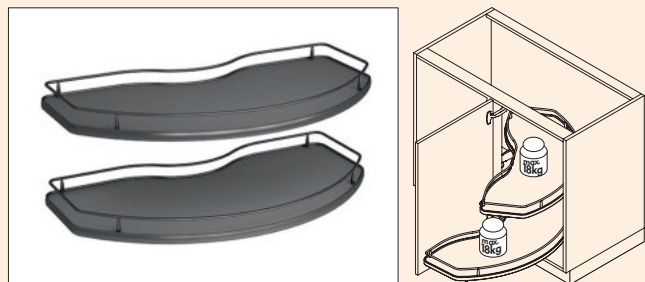

### Cornerstone Swing shelf

Storage elements for corner cupboard swivel fitting Cornerstone Swing.

- symmetrical shelf for mounting on the right and left
- for 900 mm cabinet width and 450 mm door width
- for 1000 mm cabinet width and 500 or 600 mm door width
- installation depth min. 490 mm
- door opening angle 90° so that shelves can slide out fully
- shelf variant 2/4
- load capacity max. 18 kg per shelf
- simple height adjustment of the shelves
- shelves that slide straight out: no obstruction of the adjacent cabinet
- shelves can be swivelled in and out independently of each other
- rail silver, shelf grey, thickness 16 mm
- rail anthracite, shelf anthracite, thickness 16 mm

**Set consisting of:**

- 2 x 2/4 shelf

**Please note:**

**Cornerstone Swing corner cupboard swivel fitting needs to be ordered separately!**

|                |  |                 |
|----------------|--|-----------------|
| <b>8037176</b> | 900 mm cabinet, 450 mm door, silver      | <b>172.27 €</b> |
| <b>8037177</b> | 900 mm cabinet, 450 mm door, anthracite  | <b>172.27 €</b> |
| <b>8037178</b> | 1000 mm cabinet, 500 mm door, silver     | <b>180.67 €</b> |
| <b>8037179</b> | 1000 mm cabinet, 500 mm door, anthracite | <b>180.67 €</b> |
| <b>8037180</b> | 1000 mm cabinet, 600 mm door, silver     | <b>193.28 €</b> |
| <b>8037181</b> | 1000 mm cabinet, 600 mm door, anthracite | <b>193.28 €</b> |



### Cornerstone Maxx

The Cornerstone Maxx convinces with shelves that slide straight out and a floating design with sturdy shelf areas. It enables direct access to the complete shelf content – without obstructing access to the adjoining cabinet.

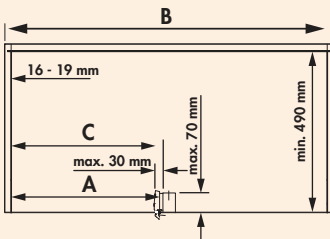
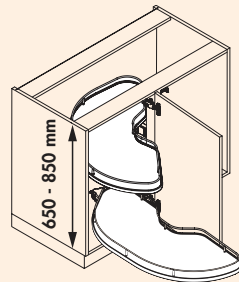
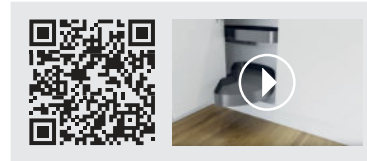

| A   | B (min.) | C        |
|-----|----------|----------|
| 450 | 900      | min. 411 |
| 500 | 1000     | min. 461 |
| 600 | 1000     | min. 561 |

### Cornerstone Maxx fitting set

Corner cupboard swivel fitting for accommodating shelves.

- for 900 mm cabinet width and 450 mm door width
- for 1000 mm cabinet width and 500 or 600 mm door width
- installation height 650–850 mm
- installation depth min. 490 mm
- telescopic
- swivels out to the right or left
- swivel technology that slides straight out, no obstruction of the adjacent cabinet

#### Set consisting of:

- standpipe
- 2 x swivel arm
- pipe fixture above

#### Please note:

**Shelves need to be ordered separately!**

|         |            |          |
|---------|------------|----------|
| 8037098 | silver     | 436.55 € |
| 8037130 | anthracite | 436.55 € |

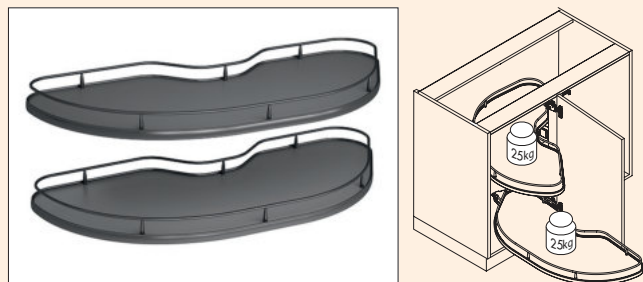

### Cornerstone Maxx shelf

Storage elements for corner cupboard swivel fitting Cornerstone Maxx.

- right and left variants
- for 900 mm cabinet width and 450 mm door width
- for 1000 mm cabinet width and 500 or 600 mm door width
- installation depth min. 490 mm
- door opening angle 85° so that shelves can slide out fully
- shelf variant 2/4
- load capacity max. 25 kg per shelf
- simple height adjustment of the shelves
- shelves that slide straight out: no obstruction of the adjacent cabinet
- shelves can be swivelled in and out independently of each other
- rail silver, shelf grey, thickness 16 mm
- rail anthracite, shelf anthracite, thickness 16 mm
- **door end stop right = left shelf**
- **door end stop left = right shelf**

**Set consisting of:**

- 2 x 2/4 shelf

**Please note:**

**Cornerstone Maxx corner cupboard swivel fitting needs to be ordered separately!**

|                |   |                 |
|----------------|---|-----------------|
| <b>8037101</b> | 900 mm cabinet, 450 mm door, right, silver      | <b>206.64 €</b> |
| <b>8037131</b> | 900 mm cabinet, 450 mm door, right, anthracite  | <b>206.64 €</b> |
| <b>8037100</b> | 900 mm cabinet, 450 mm door, left, silver       | <b>206.64 €</b> |
| <b>8037132</b> | 900 mm cabinet, 450 mm door, left, anthracite   | <b>206.64 €</b> |
| <b>8037103</b> | 1000 mm cabinet, 500 mm door, right, silver     | <b>220.08 €</b> |
| <b>8037133</b> | 1000 mm cabinet, 500 mm door, right, anthracite | <b>220.08 €</b> |
| <b>8037102</b> | 1000 mm cabinet, 500 mm door, left, silver      | <b>220.08 €</b> |
| <b>8037134</b> | 1000 mm cabinet, 500 mm door, left, anthracite  | <b>220.08 €</b> |
| <b>8037105</b> | 1000 mm cabinet, 600 mm door, right, silver     | <b>229.08 €</b> |
| <b>8037135</b> | 1000 mm cabinet, 600 mm door, right, anthracite | <b>229.08 €</b> |
| <b>8037104</b> | 1000 mm cabinet, 600 mm door, left, silver      | <b>229.08 €</b> |
| <b>8037170</b> | 1000 mm cabinet, 600 mm door, left, anthracite  | <b>229.08 €</b> |

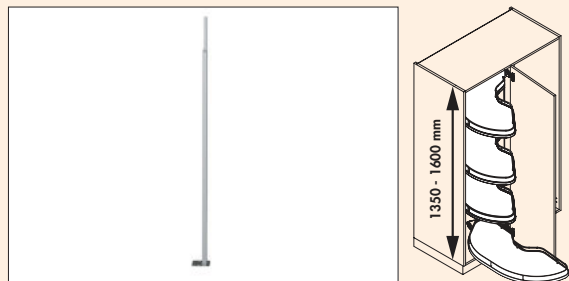

### Cornerstone Maxx standpipe

System component for height extension for corner cupboard swivel fitting Cornerstone Maxx.

- for attaching up to four swivel arms
- for 900 mm cabinet width and 450 mm door width
- for 1000 mm cabinet width and 500 or 600 mm door width
- installation height 1350–1600 mm, installation depth min. 490 mm

**Please note:**

**Corner cupboard swivel fitting and shelves need to be ordered separately!**

|                |      |                |
|----------------|------|----------------|
| <b>8037099</b> | zinc | <b>56.39 €</b> |
|----------------|------|----------------|

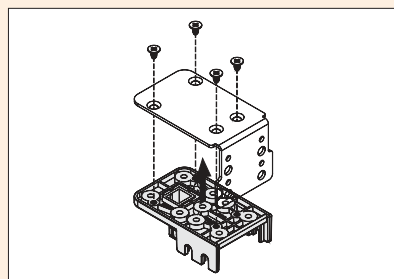

### Cornerstone Maxx blind attachment

System component for attachment of the corner cupboard swivel fittings using a blind front instead of a central post.

|                |        |                |
|----------------|--------|----------------|
| <b>8037128</b> | silver | <b>22.10 €</b> |
|----------------|--------|----------------|



### VS COR Fold

The VS COR Fold makes optimum use of the storage space in the corner cupboard. When opened, the front baskets swivel out freely and enable access to the rear baskets, which automatically move forward into the front part of the cupboard. The integrated damping with self-closing ensures silent closing.

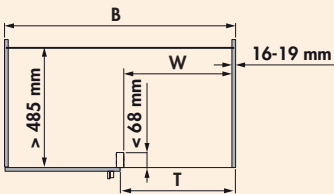
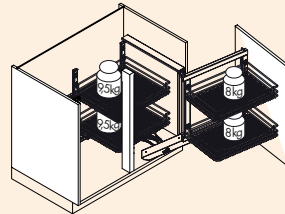

|   | K800     | K900     |
|---|----------|----------|
| B | min. 800 | min. 900 |
| T | min. 400 | min. 450 |
| W | ≥361     | ≥411     |

### VS COR Fold frame

Corner cupboard swivel fitting for 800 mm and 900 mm cabinet widths.

- for 800 mm cabinet width and 400 mm door width
- for 900 mm cabinet width and 450 mm door width
- installation depth min. 485 mm
- installation height min. 530 mm
- swivels out to the right or left
- full pull-out with damping
- tool-free mounting of the front on the drawer
- 3D front adjustment
- load capacity of the system: max. 35 kg
- **frame right = swivels out to the right**
- **frame left = swivels out to the left**

**Please note:**

**Baskets need to be ordered separately!**

|                |  |                 |
|----------------|--|-----------------|
| <b>8037073</b> | 800 mm cabinet, 400 mm door, right, silver     | <b>406.97 €</b> |
| <b>8037074</b> | 800 mm cabinet, 400 mm door, left, silver      | <b>406.97 €</b> |
| <b>8037136</b> | 800 mm cabinet, 400 mm door, right, anthracite | <b>406.97 €</b> |
| <b>8037137</b> | 800 mm cabinet, 400 mm door, left, anthracite  | <b>406.97 €</b> |
| <b>8037075</b> | 900 mm cabinet, 450 mm door, right, silver     | <b>415.04 €</b> |
| <b>8037076</b> | 900 mm cabinet, 450 mm door, left, silver      | <b>415.04 €</b> |
| <b>8037138</b> | 900 mm cabinet, 450 mm door, right, anthracite | <b>415.04 €</b> |
| <b>8037139</b> | 900 mm cabinet, 450 mm door, left, anthracite  | <b>415.04 €</b> |

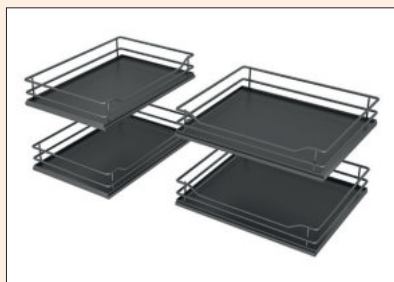

### VS COR Fold Premea basket set

Storage elements for VS COR Fold frame.

- for 800 mm and 900 mm cabinet widths
- dimensions front baskets 84 x 450 x 230/305 mm (H x W x D)
- dimensions back baskets 84 x 330/430 x 370 mm (H x W x D)
- load capacity front baskets max. 8 kg per basket
- load capacity back baskets max. 9.5 kg per basket
- rail silver, shelf grey, thickness 8 mm
- rail anthracite, shelf anthracite, thickness 8 mm

**Set consisting of:**

- 2 front baskets
- 2 back baskets

|                |                            |                 |
|----------------|----------------------------|-----------------|
| <b>8037077</b> | 800 mm cabinet, silver     | <b>323.36 €</b> |
| <b>8037140</b> | 800 mm cabinet, anthracite | <b>323.36 €</b> |
| <b>8037078</b> | 900 mm cabinet, silver     | <b>340.50 €</b> |
| <b>8037141</b> | 900 mm cabinet, anthracite | <b>340.50 €</b> |



### VS COR Wheel Pro

The corner cupboard solution VS COR Wheel Pro is characterised by its unique design. The otherwise standard, space-consuming standpipe is now superfluous. This creates up to 20 percent more storage space in the centre of the shelf.

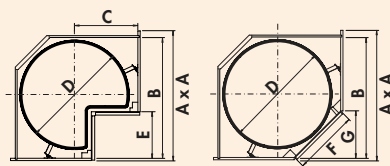
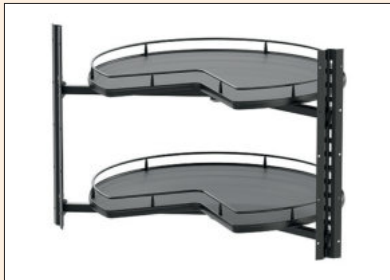

| A x A<br>mm | B<br>mm | C<br>mm | D<br>mm | E<br>mm | F<br>mm | G<br>mm |
|-------------|---------|---------|---------|---------|---------|---------|
| 900 x 900   | > 835   | 440     | 760     | < 335   | < 455   | < 321   |

### VS COR Wheel Pro

Corner cupboard swivel fitting for optimum space utilisation.

- for 900 x 900 mm cabinet widths
- installation height 620 mm
- body side depth min. 490 mm
- shelf variants 3/4 or 4/4
- load capacity max. 27.5 kg per shelf
- invisible mechanics
- individual height adjustment of the shelves
- tool-free installation of the shelves on the support arms
- rail silver, shelf grey, thickness 16 mm
- rail anthracite, shelf anthracite, thickness 16 mm

**8037114** 900 x 900 mm cabinet, 3/4, 2 pc., silver **494.03 €**

**8037142** 900 x 900 mm cabinet, 3/4, 2 pc., anthracite **494.03 €**

**8037122** 900 x 900 mm cabinet, 4/4, 2 pc., silver **475.21 €**

**8037143** 900 x 900 mm cabinet, 4/4, 2 pc., anthracite **475.21 €**





### VS SUB Slim

The VS SUB Slim tiered pull-out makes optimum use of the niches in the kitchen. As a shelf, towel holder or baking tray holder, it makes use of even the smallest gaps.

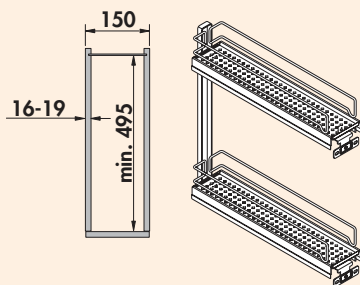

### VS SUB Slim shelf

Tiered pull-out incl. two storage elements and complete pull-out runner.

- cabinet width 150 mm
- installation depth min. 495 mm
- installation height min. 530 mm
- end stop only right
- 2 storage elements
- load capacity max. 6 kg per storage element
- integrated damping and self-closing in both runners
- rail silver or anthracite
- 3D front adjustment

|                           |                 |
|---------------------------|-----------------|
| <b>8037001</b> silver     | <b>149.16 €</b> |
| <b>8037144</b> anthracite | <b>149.16 €</b> |

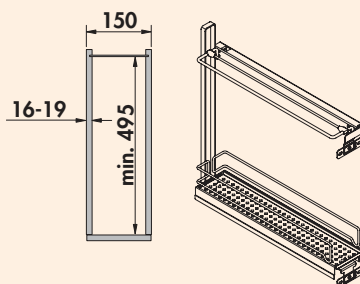

### VS SUB Slim baking tray holder

Tiered pull-out with baking tray holder and storage element, incl. complete pull-out runner.

- cabinet width 150 mm
- installation depth min. 495 mm
- installation height min. 530 mm
- end stop only right
- 1 baking tray holder and 1 storage element
- load capacity max. 6 kg per storage element
- integrated damping and self-closing in both runners
- rail silver or anthracite
- 3D front adjustment

|                           |                 |
|---------------------------|-----------------|
| <b>8037002</b> silver     | <b>165.29 €</b> |
| <b>8037145</b> anthracite | <b>165.29 €</b> |

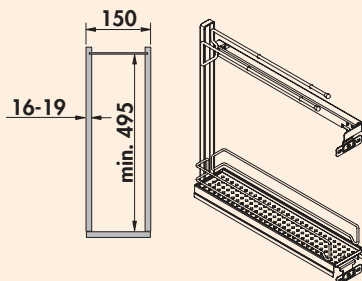

### VS SUB Slim towel holder

Tiered pull-out with towel holder and storage element, incl. complete pull-out runner.

- cabinet width 150 mm
- installation depth min. 495 mm
- installation height min. 530 mm
- end stop only right
- 2-fold towel holder and 1 storage element
- load capacity max. 6 kg per storage element
- integrated damping and self-closing in both runners
- rail silver or chrome
- 3D front adjustment

|                       |                 |
|-----------------------|-----------------|
| <b>8037003</b> silver | <b>158.99 €</b> |
|-----------------------|-----------------|

|                           |                 |
|---------------------------|-----------------|
| <b>8037146</b> anthracite | <b>158.99 €</b> |
|---------------------------|-----------------|



### VS SUB Side

The VS SUB Side pull-out allows you to make maximum use of the storage space in a 300 mm wide cabinet.

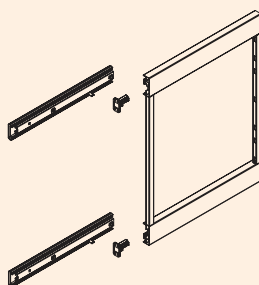
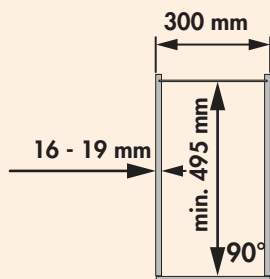
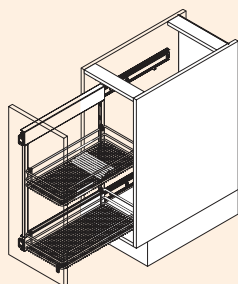

### VS SUB Side frame

Pull-out drawer incl. runners.

- cabinet width 300 mm
- installation depth min. 495 mm
- installation height min. 619 mm
- end stop left or right
- 2 runners
- integrated damping and self-closing in both runners
- load capacity of the system max. 20 kg
- individual height adjustment of the baskets
- 3D front adjustment
- tool-free mounting of the front on the drawer

**Please note:**

**Baskets need to be ordered separately!**

|  |                 |
|--|-----------------|
| <b>8037007</b> H 619 mm, for 2 baskets, silver     | <b>149.16 €</b> |
| <b>8037147</b> H 619 mm, for 2 baskets, anthracite | <b>149.16 €</b> |



### VS SUB/TAL Side Premea basket set

Storage elements for VS SUB/TAL Side frame.

- basket dimensions 84 x 220 x 470 mm (H x W x D)
- suitable for cabinet width 300 mm
- set consisting of two baskets
- rail silver, shelf grey, thickness 8 mm
- rail anthracite, shelf anthracite, thickness 8 mm

|                           |                 |
|---------------------------|-----------------|
| <b>8037010</b> silver     | <b>118.57 €</b> |
| <b>8037148</b> anthracite | <b>118.57 €</b> |



### Internal pull-out Classic

Pull-out basket. With integrated damping and self-closing (Grass Nova pro runner).

Suitable for wall thickness 16/18/19 mm.

- installation depth min. 500 mm
- installation height 120 mm incl. runner
- spacer strip for mounting behind the door
- load-bearing capacity max. 20 kg

|                |                               |                 |
|----------------|-------------------------------|-----------------|
| <b>8031180</b> | 450 mm cabinet, chrome-plated | <b>136.55 €</b> |
| <b>8031181</b> | 500 mm cabinet, chrome-plated | <b>141.01 €</b> |
| <b>8031182</b> | 600 mm cabinet, chrome-plated | <b>146.39 €</b> |

|                |                            |                 |
|----------------|----------------------------|-----------------|
| <b>8031183</b> | 450 mm cabinet, anthracite | <b>131.18 €</b> |
| <b>8031184</b> | 500 mm cabinet, anthracite | <b>136.55 €</b> |
| <b>8031185</b> | 600 mm cabinet, anthracite | <b>141.01 €</b> |



### SpaceFlexx set

The flexible organising system SpaceFlexx solves the chaos of disorderly storage jars in drawers. It convinces with its optimal use of storage space and perfect adaptation to the contents and drawer.

The flexible division nesttex®, straps made of a special high-tech textile, adapts perfectly to the geometry of the jars. The belt straps are machine washable, German engineering und made in Germany.



### SpaceFlexx set

Organising system. Suitable for all drawers from a width of 600 mm.

**Set consisting of:**

- 1 frame
- 5 flexible divisions nesttex®
- dimensions 130 x 472/520 x 472 mm (H x W x D)
- **width adjustment with 472 or 520 mm, for optimum adjustment to the drawer**

|                |            |                 |
|----------------|------------|-----------------|
| <b>8031078</b> | anthracite | <b>136.81 €</b> |
|----------------|------------|-----------------|



### Swivel mechanics 1

Suitable for any cabinet width, for electric slicer from 450 mm cabinet width. Swings larger appliances stored in the base unit, for instance electric slicers parallel-horizontally to the level of the worktop, by employing two springs.

- load bearing capacity 8 kg
- useable height 310 mm
- swivelling depth 505 mm

|               |          |
|---------------|----------|
| 1111036 white | 152.94 € |
|---------------|----------|

#### Spare parts

|   |        |
|---|--------|
| 1110003 Spring for swivel mechanism, L ca. 165 mm | 9.33 € |
|---|--------|



### Swivel mechanics 2

Infinitely variable adjustment from 410–570 mm cab. width.

Swings larger appliances stored in the base unit, for instance electric slicers, parallel-horizontally to the level of the worktop, by employing four springs.

- load bearing capacity 10 kg
- useable height 240 mm
- swivelling depth 505 mm

|               |          |
|---------------|----------|
| 1111037 white | 185.46 € |
|---------------|----------|

#### Spare parts

|   |        |
|---|--------|
| 1110003 Spring for swivel mechanism, L ca. 165 mm | 9.33 € |
|---|--------|





### TopFlex pull-out table

Hidden invisibly and compactly behind a drawer front plate, the pull-out table is activated only when needed.

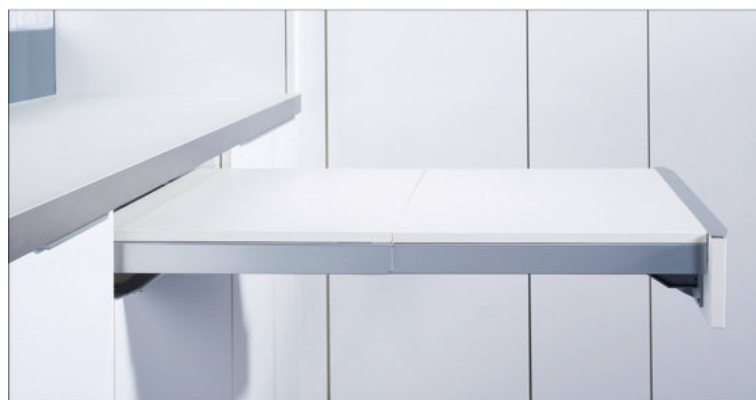

### TopFlex pull-out table fitting

Freely suspended and without table top.  
 – with lowerable front  
 – extendable up to 810 mm  
 – independent of width from 450–900 mm  
 – body depth min. 500 mm  
 – load bearing capacity max. 30 kg

1111033 silver

266.39 €



### TopFlex pull-out table

Preassembled with white melamine resin coated table top.  
 – with lowerable front  
 – 16 x 546 x 422 mm (H x W x D)  
 – load bearing capacity max. 30 kg

Not suitable for kitchens without handles.

1111034 for 600 mm cabinet, white

351.01 €





### Cox® Wash laundry container pull-outs

Cox® Wash is the clean solution for dirty washing. Because with our laundry system, dirty washing can be neatly sorted, stored and transported. Completely invisibly. The hidden chute fits perfectly into any housekeeping area. Technically and visually, the Cox® Wash is based on our tried-and-tested waste separation systems from the Cox-Clan® range. This gives recycling and laundry a uniform look. The new laundry containers in a unique variety of models have rounded openings for optimum air circulation and thus help to protect the laundry.

- soft retraction and damping
- "quick & easy" mounting frame for different body thicknesses (16/19 mm)
- "nova Pro" guide rail 510 mm deep
- available for 45, 50 and 60 cm base units
- handles light grey
- installation depth 516 mm
- installation height 580 mm

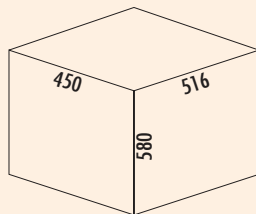

### Cox® Wash laundry container pull-out 580/450-2

- Laundry container pull-out.
- frame white/guide silver
  - technology: over extension
  - mounting: cabinet side panel and front panel
  - container volume 70 (2 x 35) litres
  - **with soft retraction and damping**
  - installation depth 516 mm

8031194 white

414.29 €

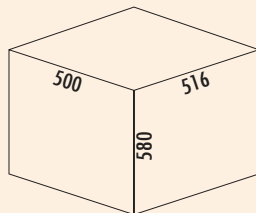

### Cox® Wash laundry container pull-out 580/500-2

- Laundry container pull-out.
- frame white/guide silver
  - technology: over extension
  - mounting: cabinet side panel and front panel
  - container volume 70 (2 x 35) litres
  - **with soft retraction and damping**
  - installation depth 516 mm

8031195 white

414.29 €

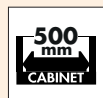

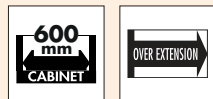
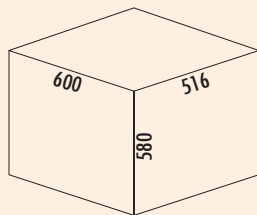

### Cox® Wash laundry container pull-out 580/600-2

- Laundry container pull-out.
- frame white/guide silver
  - technology: over extension
  - mounting: cabinet side panel and front panel
  - container volume 88 (2 x 44) litres
  - **with soft retraction and damping**
  - installation depth 516 mm

8031196 white

466.39 €

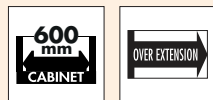
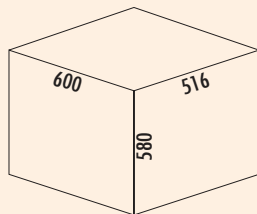

### Cox® Wash laundry container pull-out 580/600-3

- Laundry container pull-out.
- frame white/guide silver
  - technology: over extension
  - mounting: cabinet side panel and front panel
  - container volume 91 (2 x 35/1 x 21) litres
  - **with soft retraction and damping**
  - installation depth 516 mm

8031197 white

466.39 €

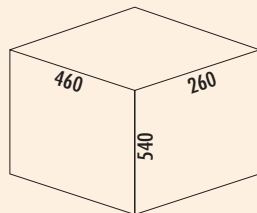

### Laundry pull-out 30

- Laundry pull-out.
- guide silver
  - technology full pull-out
  - installation cupboard bottom
  - container volumes 40 (1 x 40) liters
  - installation depth 460 mm

**When installing in 30-gauge cupboard pay attention to the hinge position.**

8031111 white

161.68 €



### Tidy laundry container pull-out 500

2-fold.

- for 500 mm cabinet width
- container volume 2 x 33 l
- metal parts sheet steel white, plastic parts white/light blue
- 545 x 462–468 x 528 mm (H x W x D)
- side wall mounting 16–19 mm
- **with covered, damped self-closing mechanism including synchronised over-extension**

8035211 white/light blue

397.98 €

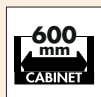

### Tidy laundry container pull-out S 600

2-fold.

- for 600 mm cabinet width
- container volume 2 x 33 l
- metal parts sheet steel white
- plastic parts white/light blue
- 545 x 562–568 x 448 mm (H x W x D)
- side wall mounting 16–19 mm
- sytem depth only 448 mm
- **with covered, damped self-closing mechanism including synchronised over-extension**

8035213 white/light blue

456.39 €

Cabinet  
equipment

# STOREX®

## Holders and hooks

Most welcome



|                            |              |
|----------------------------|--------------|
| ■ Cox Work®                | Page 524–526 |
| ■ Cleaning Agent           | Page 527     |
| ■ Vario organising system  | Page 527     |
| ■ Cleaning agent pull-outs | Page 528     |
| ■ Spacer strip             | Page 528     |
| ■ Towel holder             | Page 528–529 |
| ■ Ventilation grids        | Page 530     |
| ■ Hook strip               | Page 530     |
| ■ Cleaning agent basket    | Page 530     |

# STOREX® Cox Work® container system

All your utensils  
at your fingertips

The many useful little things of everyday life also need a place where they are always to hand. Cox Work® was developed as a practical kitchen aid and will quickly gain a fixed place as a well-designed supplementary tool in the Cox® container programme.

Aesthetic and constructive "stand-alone qualities" and an intelligent division system extend the range of applications far beyond the kitchen and household. In the office, in the workshop, in the garden and in many other hobby areas, Cox Work® saves unnecessary time spent searching for the right utensil.

- Cox Work® includes the following system parts (scope varies per set): box, small part box, 2 U-dividers and 2 V-dividers
- Cox Work® can be fittingly inserted into the 13, 16, 22 and 28 litre containers of the Cox®-container system with the system dimension 230 x 382 mm (W x D)
- Cox Work® is available in the colours light grey and anthracite
- material: ABS plastic
- dimensions 161.5 x 361 x 209 mm (H x W x D)



## Applications

- toolbox insert for the Cox® container system
- office utensils box
- toolbox
- hobby box
- garden helper box
- BBQ cleaner box
- bottle box



reddot award 2019  
winner







### Cox Work®

Functional and well-organised storage space is becoming increasingly important, not only at the kitchen workplace. The well-designed Cox Work® utensil box is a practical organisation aid and can be intelligently used as a free-standing element or behind front pull-outs in Cox® systems for the orderly placement of various work materials and accessories.

Cox Work® is offered in three different versions:

- Version 1 includes Cox Work® Box in the desired colour.
- Version 2 includes a small parts box, in addition to the Cox Work® Box, which is elegantly fitted via the integrated handle and provides space for many little things.
- Version 3 also includes two V- and U-shaped dividers. These subdivide Cox Work® and create clearly structured storage space.

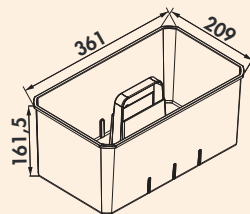
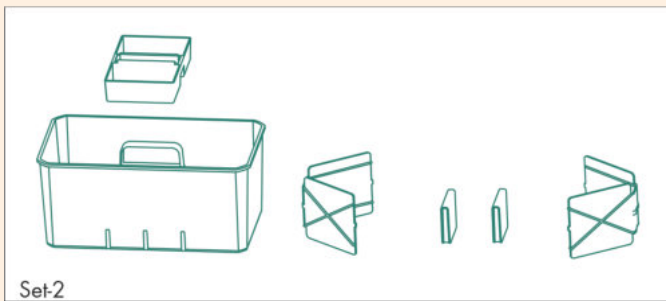
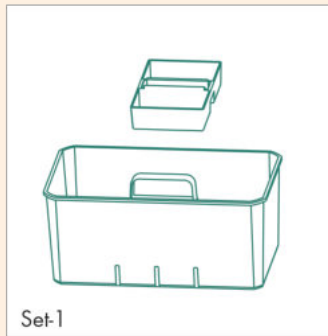

### Cox Work® Concrete

Utensil box. For storage of, e.g. brushes, cleaners, tabs and cloths.

- mobile utensil box, light grey
- various applications
- can be integrated into all Cox® container systems with Cox® system dimensions 230 x 382 mm

|  |                 |
|--|-----------------|
| <b>8012530</b> Cox Work® Box   | <b>57.06 €</b>  |
| <b>8012531</b> set 1, incl. small parts box                          | <b>71.60 €</b>  |
| <b>8012532</b> set 2, incl. small parts box, 2 x U-divider/V-divider | <b>118.57 €</b> |
| <b>Optional accessories</b>  |                 |
| <b>8012533</b> small parts box Concrete/Carbon                       | <b>16.64 €</b>  |
| <b>8012534</b> U-divider Concrete/Carbon                             | <b>5.21 €</b>   |
| <b>8012535</b> V-divider Concrete/Carbon                             | <b>21.85 €</b>  |

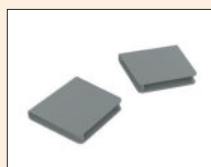

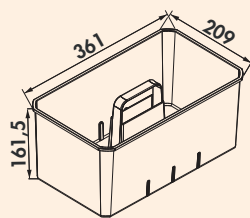

### Cox Work® Carbon

Utensil box. For storage of, e.g. brushes, cleaners, tabs and cloths.

- mobile utensil box, anthracite
- various applications
- can be integrated into all Cox® container systems with Cox® system dimensions 230 x 382 mm

|  |                 |
|--|-----------------|
| <b>8012540</b> Cox Work® Box   | <b>57.06 €</b>  |
| <b>8012541</b> set 1, incl. small parts box                          | <b>71.60 €</b>  |
| <b>8012542</b> set 2, incl. small parts box, 2 x U-divider/V-divider | <b>118.57 €</b> |

#### Optional accessories

|  |                |
|--|----------------|
| <b>8012533</b> small parts box Concrete/Carbon | <b>16.64 €</b> |
| <b>8012534</b> U-divider Concrete/Carbon       | <b>5.21 €</b>  |
| <b>8012535</b> V-divider Concrete/Carbon       | <b>21.85 €</b> |



### Cleaning Agent

**Absolutely practical**, very solid and extremely compact in design. In the smallest of spaces, Cleaning Agent offers many practical details and plenty of space to carry everything you need for cleaning. Sponges, brushes and other tools are always at hand on the top tray.

It can be pulled out with one finger – thanks to the Softstopp it closes gently and quietly.

Especially handy: the cleaning agent basket with ergonomic handle. All plastic bowls can be removed and cleaned in the dishwasher – so that the Cleaning Agent is always clean.



### Cleaning Agent

Cleaning agent pull-out. With ergonomic carrying handle.

Consisting of:

- 1 system support
- 1 insertable basket with carrying handle
- 2 large and 1 small container
- 6 separating hoops
- 480 x 298 x 480 mm (H x W x D)

8031103 grey

148.49 €



### Vario organising system

The consistent elliptic design of the anodised aluminium profiles in connection with the square, perforated base plate and the high-quality, stable plastic elements gives the organising system Vario its exclusive character.

Vario may be installed on the right or left in the floor cabinet.



### Vario organizing system 3909

Pull-out for installation on the side wall, 3-part, with one large and two narrow trays.

- 481 x 158 x 483 mm (H x W x D)

8035010 aluminium

232.69 €



### Cleaning agent pull-out model 1

Two levels, complete with pull-out guide.  
Enables better use of the storage space below the sink.  
— 420 x 190 (205 mm incl. guide) x 425 mm (H x W x D)

For each pull-out, 2 spacer strips are required for bridging the door hinges. Order separately if needed.

8031023 chrome 145.80 €



### Cleaning agent pull-out model 3

Pull-out basket. For clear placing of cleaning and dishwashing agents.  
— 400 x 117 (140 mm incl. guide) x 470 mm (H x W x D)

For each pull-out, 2 spacer strips are required for bridging the door hinges. Order separately if needed.

8031042 chrome 140.42 €

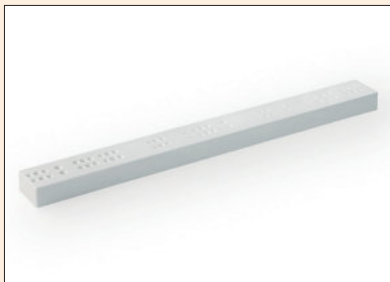

### Spacer strip

Plastic, for ball guide, to bridge the door hinges.  
2 spacer strips are needed per pull-out.

8031041 width 25 mm 13.95 €



### Towel holder Secco AluLine

Two or three armed version available.  
Universal installation, installation from a width of 150 mm, extendable.  
— length 457 mm

8032015 2-armed, W 122 mm, aluminium/graphite-grey 50.76 €

8032016 3-armed, W 184 mm, aluminium/graphite-grey 57.48 €



### Towel holder Secco S

One-armed version.  
Installation for all front pull-outs, adjustable to fit all cabinet situations. The towel disappears aesthetically and discretely into the pull-out cabinet when not in use.  
— length 457 mm  
— height 200 mm

8032017 1-armed, lightgrey 29.83 €



### Towel holder De Luxe S

Two or three armed version available. Universal installation on the side wall or underneath, 495 mm long, extendable.

Cover not included in scope of delivery, please order separately.

8031048 2-armed, W 102 mm, chrome 64.03 €

8031049 3-armed, W 145 mm, chrome 69.08 €

### Optional accessories

8031009 Cover for towel holder 7.90 €



### Towel holder De Luxe 1

Two or three armed version available. Aluminium version.  
Universal installation on the side wall or underneath, L 465 mm, extendable.

|         |                           |         |
|---------|---------------------------|---------|
| 8032005 | 2-armed, W 95 mm, silver  | 52.02 € |
| 8032008 | 3-armed, W 143 mm, silver | 65.97 € |



### Towel holder De Luxe 2

Two or three armed version available. Universal installation on the side wall or underneath, L 410 mm, extendable.

Cover not included in scope of delivery, please order separately.

|         |                     |         |
|---------|---------------------|---------|
| 8032014 | 2-armed, anthracite | 70.08 € |
| 8032018 | 3-armed, anthracite | 73.70 € |

#### Optional accessories

|         |                                |        |
|---------|--------------------------------|--------|
| 8032019 | Cover for De Luxe 2 towel rail | 8.32 € |
|---------|--------------------------------|--------|



### Towel holder for bathrooms with cover

One or two armed version available.  
For installation on the side, 325 mm long, extendable.

|         |                           |         |
|---------|---------------------------|---------|
| 8031089 | 1-armed, W 65 mm, chrome  | 60.42 € |
| 8031090 | 2-armed, W 105 mm, chrome | 70.08 € |

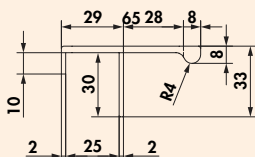

### Towel holder for handle-less kitchens

- aluminium anodised
- for handle-less kitchens, with front thickness of 16–21 mm
- no installation work, simply push-on
- felt insert supplied loose, glue in prior to fitting

|         |                                    |         |
|---------|------------------------------------|---------|
| 8032009 | L 320 mm, stainless steel coloured | 41.43 € |
| 8032023 | L 320 mm, black matt               | 41.43 € |
| 8032010 | L 520 mm, stainless steel coloured | 69.41 € |
| 8032013 | L 520 mm, black matt               | 69.41 € |





### Ventilation grid 1

Metal ventilation grid. Ventilation shaft 313 cm<sup>2</sup>/m.

- (1) W 250 mm, D 70 mm, cut-out dimension W 225 mm x D 58 mm
- (2) W 500 mm, D 70 mm, cut-out dimension W 475 mm x D 58 mm
- (3) W 750 mm, D 70 mm, cut-out dimension W 725 mm x D 58 mm
- (4) W 900 mm, D 70 mm, cut-out dimension W 875 mm x D 58 mm

**8033050** (1) silver **14.03 €**

**8033051** (1) stainless steel col. **16.30 €**

**8033052** (1) black matt **15.29 €**

**8033053** (2) silver **22.35 €**

**8033054** (2) stainless steel col. **30.92 €**

**8033055** (2) black matt **29.08 €**

**8033056** (2) white **31.76 €**

**8033057** (3) silver **32.69 €**

**8033058** (3) stainless steel col. **39.16 €**

**8033059** (3) black matt **36.81 €**

**8033060** (4) silver **36.64 €**

**8033061** (4) stainless steel col. **43.95 €**

**8033062** (4) black matt **43.95 €**



### Ventilation grid 2

Metal ventilation grid.

- 500 x 110 mm (W x D)
- cut-out dimension 475 x 98 mm (W x D)
- ventilation area ca. 496 cm<sup>2</sup>

**8033005** silver **24.71 €**

**8033028** stainless steel col. **29.41 €**

**8033027** black matt **27.39 €**

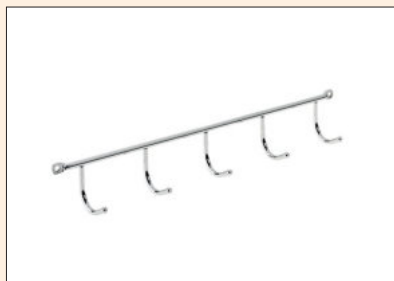

### Hook strip

For wall mounting. 5 hooks.

- 49 x 350 x 43 mm (H x W x D)

**8031031** chrome **11.51 €**



### Cleaning agent basket 1

Closed on three sides, may be bolted. With hooks for cloths and dusters.

- 100 x 330 x 115 mm (H x W x D)

**8031117** silver **17.90 €**



# STOREX®

## Built-in appliances for drawers

Concealed and immediately  
good to go



|                       |              |
|-----------------------|--------------|
| Multi-slicers         | Page 532–534 |
| Metal crossbar        | Page 533     |
| Evoline® Wing         | Page 534     |
| Built-in toaster      | Page 535     |
| Built-in hand blender | Page 535     |

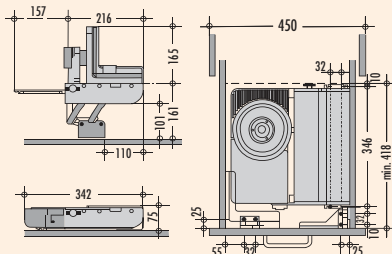
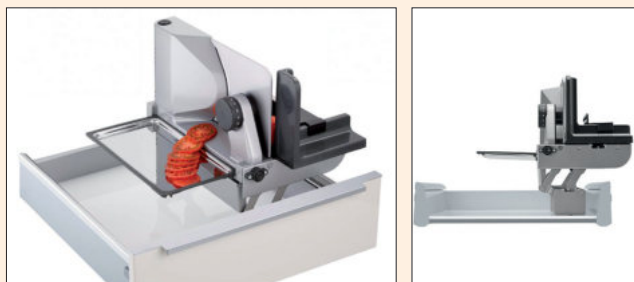

**ritter multi-cutter AES 72 SR**



For installation in drawers from 450 mm cabinet width. Prerequisite: clear internal dimension: >344 mm. Stands in front of the worktop. Distance from drawer bottom to upper worktop edge min. 116 mm, max. 161 mm.

- high-quality all-metal design
- drive: high-performance energy-saving motor 230 V, 65 watt short-time, operation 5 minutes
- 2 finger safety switching system
- circular blade: electrolytically polished edge Ø 170 mm, serrated
- bayonet quick lock for tool-free blade removal
- cutting width adjustment: up to approx. 14 mm
- fold-in lock when slice thickness set
- stand fitting locks automatically
- cable length 80 cm
- 75 x 342 x 365 mm (H x W x D), weight 4.3 kg
- accessories: cuttings tray made of stainless steel, fixing bracket for finger protection and left-overs holder
- 5 years manufacturer's warranty (see [www.ritterwerk.de/garantie](http://www.ritterwerk.de/garantie))

**1111044** silver metallic, cuttings guided on the right **760.50 €**

**Optional accessories**

**1111067** Ham slicer, smooth **97.48 €**

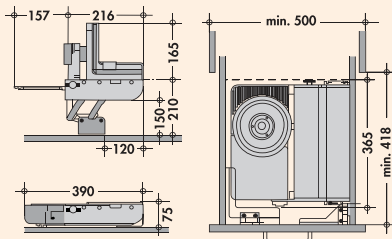
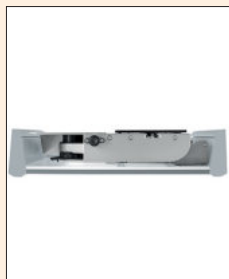
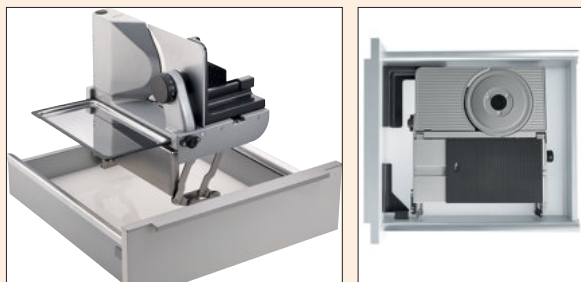

**ritter multi-cutter AES 72 SR-H**



High version for installation in drawers from 500 mm cabinet width. Prerequisite: clear internal dimension: >392 mm. Stands in front of the worktop. Distance from drawer bottom to countertop top min. 165 mm, max. 210 mm. Particularly suitable for handle-less kitchens or thicker work surfaces.

- high-quality all-metal design
- drive: high-performance energy-saving motor 230 V, 65 watt short-time, operation 5 minutes
- child safety lock with 2-finger activation system
- circular blade: polished edge, Ø 170 mm, serrated, the scissor lift and stand fitting locks automatically
- bayonet quick lock for tool-free blade removal
- cutting width adjustment: up to approx. 14 mm
- fold-in lock when slice thickness set
- set-up fitting locks automatically
- cable length 80 cm
- 75 x 390 x 365 mm (H x W x D), weight 4.3 kg
- accessories: cuttings tray made of stainless steel, fixing bracket for finger protection and left-overs holder
- 5 years manufacturer's warranty (see [www.ritterwerk.de/garantie](http://www.ritterwerk.de/garantie))

**1111030** silver metallic, cuttings guided on the right **845.38 €**

**Optional accessories**

**1111067** Ham slicer, smooth **97.48 €**

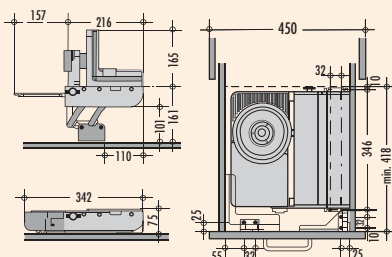

**ritter multi-cutter model AES 62**



For installation in drawers from 450 mm cabinet width. Prerequisite: clear internal dimension: >344 mm. Stands in front of the worktop. Distance from drawer bottom to upper worktop edge: min. 116 mm, max. 161 mm.

- drive: high-performance energy-saving motor 230 V, 65 watt, safety-brief and continuous operation switch, short-time operation 5 minutes
- metal design
- round blade: polished blade Ø 170 mm, with serrated edge
- cutting width adjustment: up to approx. 14 mm
- fold-in lock when slicethickness set
- stand fitting locks automatically
- cable length 80 cm
- 75 x 342 x 365 mm (H x W x D), weight: 4.1 kg
- accessories: cuttings tray made of stainless steel, fixing bracket for finger protection and left-overs holder
- 5 years manufacturer's warranty (see [www.ritterwerk.de/garantie](http://www.ritterwerk.de/garantie))

**1111051** silver-metallic, cuttings guided on the left **636.13 €**

**1111062** silver-metallic, cuttings guided on the right **636.13 €**

**Optional accessories**

**1111058** Ham and cold cuts knife, smooth **82.18 €**

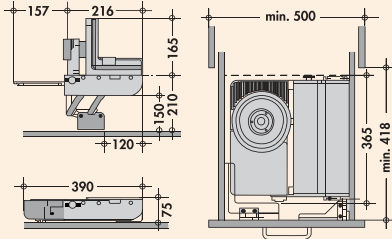
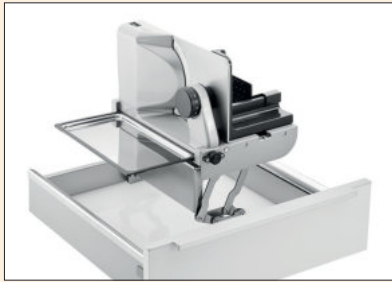

**ritter multi-cutter AES 62-H**



High version for installation in drawers from 500 mm cabinet width. Prerequisite: clear internal dimension: >392 mm. Stands in front of the worktop.

**Distance from drawer bottom to countertop top min. 165 mm, max. 210 mm. Particularly suitable for handle-less kitchens or thicker work surfaces.**

- drive: high-performance energy-saving motor 230 V, 65 watt short-time, operation 5 minutes
- metal design
- circular blade: polished edge, Ø 170 mm, serrated, the scissor lift and stand fitting locks automatically
- cutting width adjustment: up to approx. 14 mm, fold-in lock when slice thickness set
- cable length 80 cm
- 75 x 390 x 365 mm (H x W x D), weight 4.1 kg
- accessories: cuttings tray made of stainless steel, fixing bracket for finger protection and left-overs holder
- 5 years manufacturer's warranty (see [www.ritterwerk.de/garantie](http://www.ritterwerk.de/garantie))

|   |          |
|---|----------|
| 1111031 silver metallic, cuttings guided on the left  | 724.37 € |
| 1111032 silver metallic, cuttings guided on the right | 724.37 € |

**Optional accessories**

|   |         |
|---|---------|
| 1111058 Ham and cold cuts knife, smooth | 82.18 € |
|---|---------|

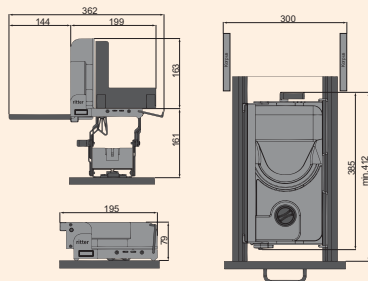

**ritter multi-cutter model AES 52**



For installation in drawers from 300 mm cabinet width. Prerequisite: clear internal dimension >197 mm. Stands in front of the worktop.

- drive: high-performance energy-saving motor 230 V, 65 watt, safety, brief and continuous operation switch, short-time operation 5 minutes.
- metal design
- round blade: polished blade, Ø 170 mm, with serrated edge
- cutting thickness setting: up to approx. 14 mm
- fold-in lock when slice thickness set
- stand fitting locks automatically
- device can be removed from the draw without tools for cleaning
- cable length 80 cm
- 79 x 195 x 385 mm (H x W x D), poids 4.3 kg
- accessories: cuttings tray, plastic
- 5 years manufacturer's warranty (see [www.ritterwerk.de/garantie](http://www.ritterwerk.de/garantie))

|   |          |
|---|----------|
| 1111043 silver-metallic, cuttings guided on the right | 726.89 € |
|---|----------|

**Optional accessories**

|   |         |
|---|---------|
| 1111058 Ham and cold cuts knife, smooth | 82.18 € |
|---|---------|

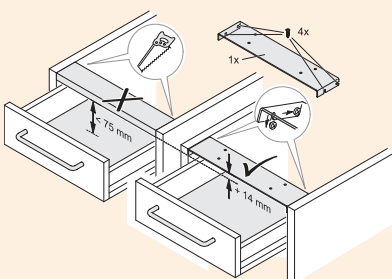

**Metal crossbar**

Suitable for all built-in multi-cutters and built-in toasters. The metal crossbars are needed if the clearance height is not sufficient for mounting, e.g. for under-floor guides or, to some extent, in case of handleless kitchens. If the standard crossbars are replaced by the thin metal crossbars, as a rule, 14 mm clearance height is gained. Only suitable for cabinets with 16 mm wall thickness.

|                             |          |
|-----------------------------|----------|
| 1111046 for 300 mm cabinet  | 44.71 €  |
| 1111057 for 400 mm cabinet  | 47.82 €  |
| 1111068 for 450 mm cabinet  | 49.66 €  |
| 1111069 for 500 mm cabinet  | 53.70 €  |
| 1111070 for 600 mm cabinet  | 57.48 €  |
| 1111071 for 800 mm cabinet  | 86.55 €  |
| 1111077 for 900 mm cabinet  | 88.24 €  |
| 1111078 for 1000 mm cabinet | 96.64 €  |
| 1111084 for 1200 mm cabinet | 110.92 € |



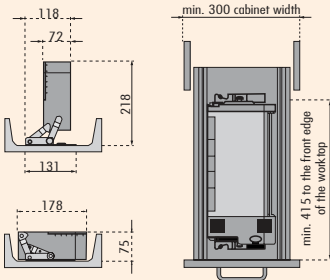
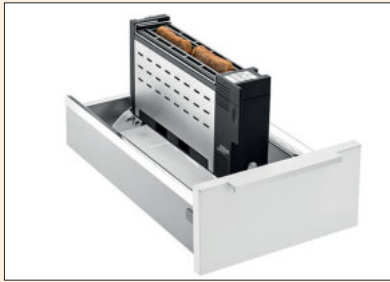

### ritter built-in toaster ET 10



Built-in toaster for mounting in drawers from 300 mm cabinet width. Prerequisite: clear internal dimension >180 mm.

- dimensions when retracted: 75 x 178 x 400 mm (H x W x D)
- stand mechanism in metal
- safety automatic switchoff, when toaster folded in
- toasting setting with LED display
- stop button
- defrost and reheat function
- bread centring
- integrated warming rack in stainless steel
- thermally insulated stainless steel housing
- crumb catching tray can be removed in standing and in lying position
- device can be removed from the draw without tools for cleaning
- cable length 105 cm
- 220–240 volts, 850–950 watts
- weight 2 kg
- 5 years manufacturer's warranty (see [www.ritterwerk.de/garantie](http://www.ritterwerk.de/garantie))

1111045 stainless-steel/black

428.57 €

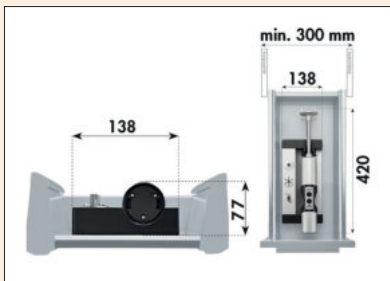

### ritter built-in hand blender ESM 50



For installation in drawers from 300 mm cabinet width. Required: clear width >145 mm.

- cordless, battery operated hand blender
- charger securely mounted into cabinet drawer
- LED charge indicator

#### 4 stainless steel attachments:

- utility knife: standard attachment for pureeing most foods
- whipping disk: for fluffy whipped foods
- stirring disc: for stirring thick creamy foods
- cutting knife: for cutting meat and fibrous fruit and vegetables
- 3 speeds: ca. 12,000 rpm, ca. 9,000 rpm, ca. 6,000 rpm
- aluminium housing, ergonomic plastic handle
- safety-2 finger-switch on system
- automatic safety shutdown in case of overload or overheating
- plug-in power supply 120 cm for charging station: input voltage 100–240 volts
- battery: 7.2 V, lithium-ion battery, 2.1 Ah
- 77 x 138 x 420 mm (H x W x D), weight 1.4 kilogram (including 400 g charging station)
- Ø 62 mm
- L 420 mm

1111090 aluminium/black

668.07 €



Cabinet  
equipment



# STOREX®

## Equipment for wall mounted cabinets

Everything in its place



Storage systems  
Stable and elegant storage Page 539–544

Lift fittings  
Clever use of storage space Page 545–550



# STOREX®

## Storage systems

Stable and elegant storage



|   |              |
|---|--------------|
| ■ Drawer container                      | Page 540–541 |
| Tray for hood cabinet                   | Page 542     |
| Boundary rail for wall mounted cabinets | Page 542     |
| Broom cupboard shelf                    | Page 542     |
| Hose holder                             | Page 542     |
| Spice racks                             | Page 543     |



### Drawer container box

Made of solid beech wood for drawer containers made of ceramic.



### Drawer container box 3

For three ceramic drawer containers. With covered wall mount.

- **drawer containers have to be ordered separately**
- 134 x 378 x 155 mm (H x W x D)
- can only be inserted horizontally

8022016 beech

178.15 €



### Drawer container box 4

For four ceramic drawer containers. With covered wall mount.

- **drawer containers have to be ordered separately**
- 134 x 500 x 155 mm (H x W x D)
- can only be inserted horizontally

8022017 beech

196.64 €



### Ceramic drawer container

- weight ca. 400 g
- capacity 0.75 l
- 106 x 116 x 145 mm (H x W x D)
- can only be inserted horizontally

8022005 smooth, white

40.50 €



### De Luxe 3

Drawer container. Three slim drawer containers in white stackable housing. The drawer container housing fits into all standard cabinets from 300 mm width with 16 mm thick side walls.

- 146 x 267 x 150 mm (H x W x D)
- can only be inserted horizontally

8021012 drawer containers crystal clear

45.80 €



### De Luxe 6

Drawer container. Six slim drawer containers in white stackable housing. The drawer container housing fits into all standard cabinets from 300 mm width with 16 mm thick side walls.

- 292 x 267 x 150 mm (H x W x D)
- can only be inserted horizontally

**8021020** drawer containers crystal clear

**80.76 €**



### Individual drawer container De Luxe

Suitable for De Luxe 3 and De Luxe 6.

- volume capacity 1 l
- 130 x 83 x 143 mm (H x W x D)
- can only be inserted horizontally

**8021026** crystal clear

**11.68 €**



### Tray for hood cabinet

The sections are simply clipped onto the base supports.



### Tray for hood cabinet

Complete with base supports, for 16 mm and 19 mm side walls.  
— 40 x 560 x 70 mm (H x W x D)

8031027 silver

14.03 €



### Boundary rail for wall mounted cabinets

For 600 mm tall cabinets. With this rail, even smaller pots or bottles won't go overboard (rail for drilling).  
— 35 x 504 mm (H x W)

8031060 chrome

10.76 €



### Broom cupboard shelf

Turns every common tall cabinet into a space wonder on four levels.  
— 872 x 350 x 174 mm (H x W x D)

8031063 silver

81.26 €



### Hose holder

Suitable for storing various hoses.  
— 100 x 198 x 55 mm (H x W x D)

8031066 silver

10.25 €





### Spice rack chrome 1

For 4 x 3 or 4 x 6 spice pots.

|  |                |
|--|----------------|
| <b>8031035</b> for 4 x 3 pots, H 425, W 202, D 66 mm | <b>44.87 €</b> |
| <b>8031036</b> for 4 x 6 pots, H 425, W 375, D 66 mm | <b>58.49 €</b> |



### Spice rack silver 1

Available in two varieties with different dimensions.

|  |                |
|--|----------------|
| <b>8031116</b> for 4 x 3 pots, H 425, W 202, D 66 mm | <b>19.41 €</b> |
| <b>8031119</b> for 4 x 6 pots, H 425, W 375, D 66 mm | <b>24.45 €</b> |

Cabinet  
equipment

# STOREX® Lift fittings

Clever use of storage space



|                     |              |
|---------------------|--------------|
| FREEslide           | Page 546     |
| Appliance holder    | Page 546     |
| Gas pressure spring | Page 547     |
| iMove               | Page 548–549 |



### Door lift fitting FREEslide

"Form follows function" – in a particularly aesthetic way. With FREEslide, the front moves straight up, which opens up a wide range of design options in kitchen planning.

FREEslide is also the perfect choice for cabinets hanging one above the other or wall cabinets with light or cornice profiles. All storage items are easily accessible and the integrated multi-position STOP guarantees an immediate and secure hold in any position. This means plenty of convenience behind a visually consistent cabinet front – not just in the kitchen, but throughout the entire house.

Adjust easily and safely:

The spring force is adjusted to different front weights for a feather-light run using a cordless screwdriver.

Minimal assembly effort:

The integrated positioning tabs ensure quick and perfect installation. With the subsequent screwing, you also save time and effort thanks to the pre-assembled Euro screws. The Euro screws grip directly on the base plate, which guarantees high stability of the movement system. As with the entire lifter family, the front connection is made using ClickFixx.

- front weight for 600-gauge width 3.4–6.7 kg
- suitable for cabinet heights 380–500 mm
- with opening support and closing damping

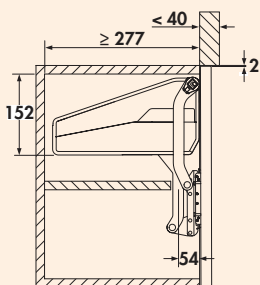

### Door lift fitting FREEslide

Parallel lift fitting for hinge-free connection of front doors. Suitable for 16 mm and 19 mm side walls.

8031082 for 600 mm width

224.37 €

Cabinet  
equipment

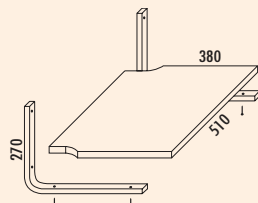

### Appliance holder

Multi-functional use for microwave ovens, television sets, radios and other small appliances, max. load bearing capacity 30 kg. with white fixing plate, melamine resin coated, with 2 mm PVC front edge.

- 19 x 510 x 380 mm (H x W x D)

8031120 holder silver coloured

141.93 €



### Gas pressure spring

- with protecting cap grey
- for door lift fittings
- Ø 19 mm
- L 210 mm

|                |       |                |
|----------------|-------|----------------|
| <b>8030101</b> | 200 N | <b>25.55 €</b> |
| <b>8030102</b> | 250 N | <b>25.55 €</b> |
| <b>8030103</b> | 380 N | <b>25.55 €</b> |



### iMove

Lift fitting. In many kitchen designs, the desire for lots of storage space and a continuous cornice height leads to wall cupboard solutions where the upper levels are not within everyone's reach. As a result, either items or even supplies are stored here that are rarely, if ever needed - or the stepladder is a regularly used kitchen aid. Both variants are far from optimal.

High time for a pull-out system which makes the contents of a wall cupboard conveniently accessible: iMove. Can be operated with one hand. The entire top shelf level is conveyed down in front of the cabinet body in one elegant movement. In this way, the items stored can be reached even more conveniently than those on the lower level of the wall cupboard. This is further facilitated by the simultaneous lowering of the shelf rail.

At the end of the movement, removing the desired objects is child's play. A tremendous benefit, especially for the youngest members of the household.

The big height differences between the wall cupboards are equalled out by iMove through a high degree of built-in flexibility - and through the choice of models with one or two levels. The iMove Single covers cabinet heights from 520 mm (no upwards limit), the iMove Double is used in cabinet heights from 710 mm. Body differences, for example the thickness of the side walls, are easily compensated by the system. Suitable for hinged doors and lifting doors. Incl. an integrated softstop. This gently decelerates the iMove and also cushions it in the closing direction.

#### Advantages:

- no adjustment necessary
- load capacity up to 8 kg
- gentle lowering
- simple lifting
- mature technology
- best materials
- safe (finger protection)

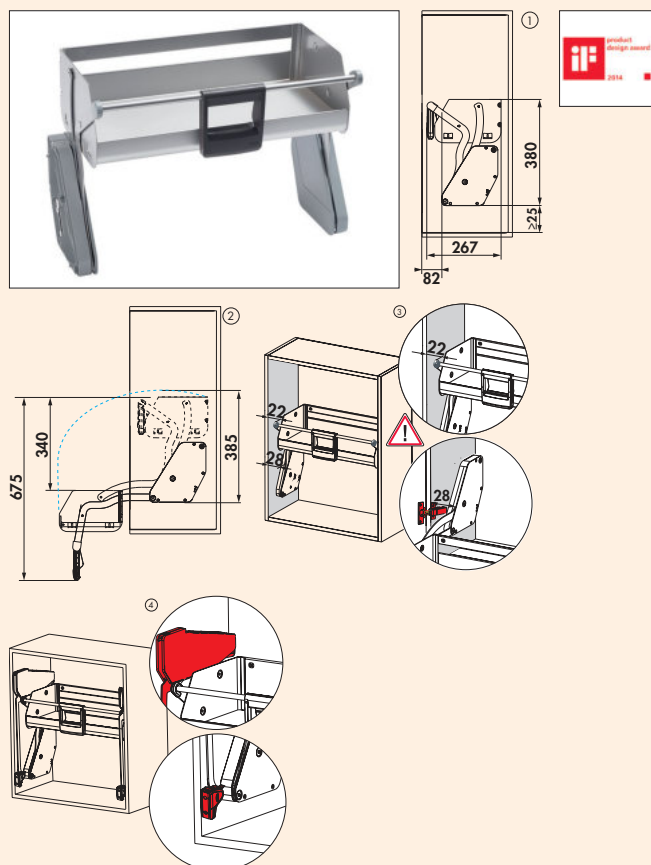

### iMove set Single Tray

Lift fitting. Silver. Incl. fittings (1 drilling template, 8 wood screws 4.5 x 50 mm). Suitable for retrofitting.

- minimum cabinet height\* (no upward limit)
- with hinged door: 520 mm
- with use of lift fittings: 650 mm
- suitable for 16 mm and 19 mm side walls
- load capacity up to 8 kg
- 380 x 267 mm (H x L)

\*cabinet height depends on hinge position, hinge protrusion or lift fitting (see illustrations 1-4).

|                                      |          |
|--------------------------------------|----------|
| 8031104 for 600 mm cabinet, W 562 mm | 354.62 € |
| 8031105 for 900 mm cabinet, W 862 mm | 376.22 € |



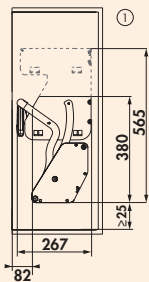

### iMove set Double Tray

Lift fitting. Silver. Incl. fittings (1 drilling template, 8 wood screws 4.5 x 50 mm). Suitable for retrofitting.

- minimum cabinet height\* (no upward limit)
- with hinged door: 710 mm
- with use of lift fittings: 710 mm
- suitable for 16 mm and 19 mm side walls
- load capacity up to 8 kg
- 565 x 267 mm (H x L)

\*Cabinet height depends on hinge position, hinge protrusion or lift fitting (see illustrations 1–4).

8031106 for 600 mm cabinet, W 562 mm

449.08 €

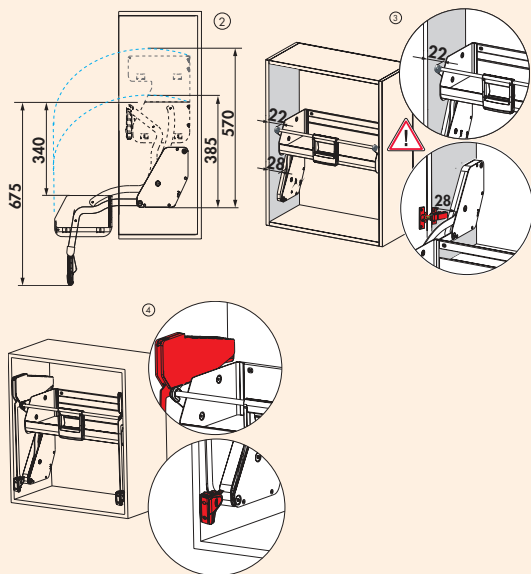

Cabinet  
equipment

# STOREX®

## Equipment for tall cabinets

Convenient and easy access



 Pullouts for tall cabinets

For the record

Page 553–558

 Storage systems

A variety of items perfectly sorted Page 559–564



# STOREX®

## Pullouts for tall cabinets

For the record



- VS TAL Side
- VS TAL Larder
- VS TAL Gate

Page 554

Page 555–556

Page 557–558



### VS TAL Side

The VS TAL Side pull-out allows you to make maximum use of the storage space in a 300 mm wide cabinet.

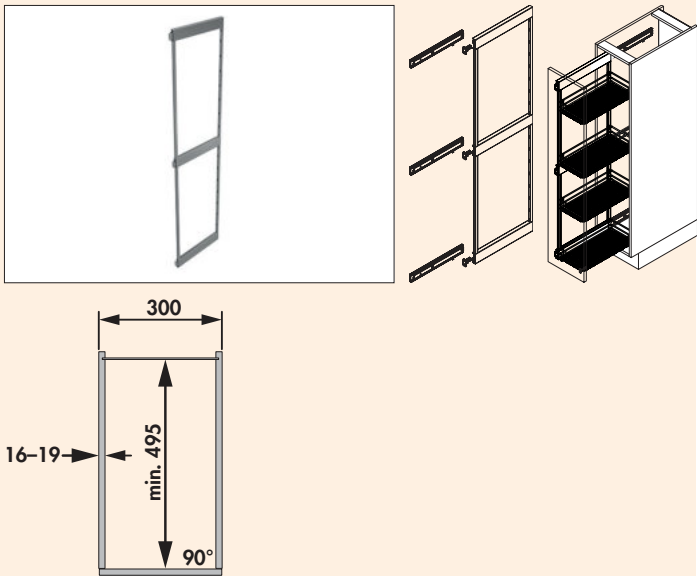

### VS TAL Side frame

Pull-out drawer incl. runners.

- cabinet width 300 mm
- installation depth min. 495 mm
- installation height min. 1222 or 1824 mm
- end stop left or right
- 3 runners
- integrated damping and self-closing in the runners
- load capacity of the system: max. 40 kg
- individual height adjustment of the baskets
- 3D front adjustment
- tool-free mounting of the front on the drawer

**Please note:**

**Baskets need to be ordered separately!**

|                |                                      |                 |
|----------------|--------------------------------------|-----------------|
| <b>8037008</b> | H 1222 mm, for 4 baskets, silver     | <b>220.08 €</b> |
| <b>8037009</b> | H 1824 mm, for 6 baskets, silver     | <b>240.76 €</b> |
| <b>8037149</b> | H 1222 mm, for 4 baskets, anthracite | <b>220.08 €</b> |
| <b>8037150</b> | H 1824 mm, for 6 baskets, anthracite | <b>240.76 €</b> |



### VS SUB/TAL Side Premea basket set

Storage elements for VS SUB/TAL Side frame.

- basket dimensions 84 x 220 x 470 mm (H x W x D)
- suitable for cabinet width 300 mm
- set consisting of two baskets
- rail silver, shelf grey, thickness 8 mm
- rail anthracite, shelf anthracite, thickness 8 mm

|                |            |                 |
|----------------|------------|-----------------|
| <b>8037010</b> | silver     | <b>118.57 €</b> |
| <b>8037148</b> | anthracite | <b>118.57 €</b> |





### VS TAL Larder

The VS TAL Larder is a classic apothecary cabinet. It allows well-conceived storage and organising of food in the kitchen. When open, the VS Tal Larder provides a good overview and quick access to the contents of the cabinet.

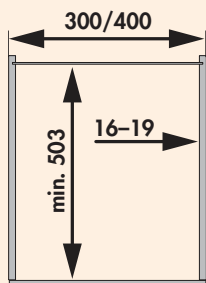
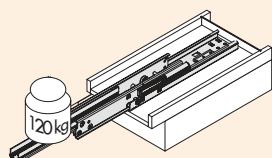
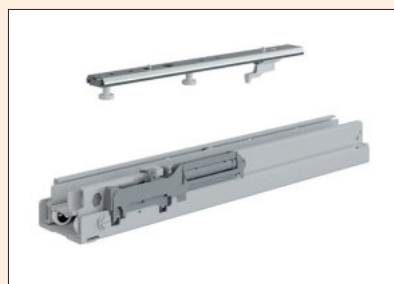

### VS TAL Larder runners

For tall cupboard pull-out VS TAL Larder.

- for 300 and 400 mm cabinet widths
- top and bottom runners
- installation depth min. 503 mm
- load capacity max. 120 kg
- drawer runner with synchronisation, self closing and damping

**Please note:**

**Support frame and baskets need to be ordered separately!**

|         |            |          |
|---------|------------|----------|
| 8037014 | light grey | 173.36 € |
| 8037152 | anthracite | 173.36 € |

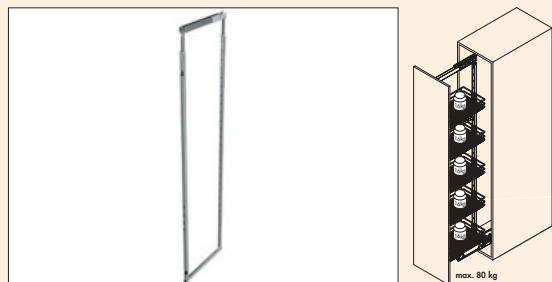

### VS TAL Larder frame

- For tall cupboard pull-out VS TAL Larder.
- cabinet width 300 and 400 mm
  - installation depth min. 503 mm
  - installation height 1200 to 2140 mm
  - support frame height telescopic
  - tool-free mounting of the frame on the lower and upper runners
  - load capacity max. 80 Kg
  - individual height adjustment of the baskets
  - 3D front adjustment

**Please note:**

**Runners and baskets need to be ordered separately!**

|                |   |                 |
|----------------|---|-----------------|
| <b>8037015</b> | H 1200–1450 mm, up to 4 baskets, silver     | <b>170.67 €</b> |
| <b>8037016</b> | H 1450–1700 mm, up to 4 baskets, silver     | <b>185.04 €</b> |
| <b>8037017</b> | H 1700–1950 mm, up to 5 baskets, silver     | <b>199.41 €</b> |
| <b>8037018</b> | H 1900–2140 mm, up to 5 baskets, silver     | <b>208.40 €</b> |
| <b>8037153</b> | H 1200–1450 mm, up to 4 baskets, anthracite | <b>170.67 €</b> |
| <b>8037154</b> | H 1450–1700 mm, up to 4 baskets, anthracite | <b>185.04 €</b> |
| <b>8037155</b> | H 1700–1950 mm, up to 5 baskets, anthracite | <b>199.41 €</b> |
| <b>8037156</b> | H 1900–2140 mm, up to 5 baskets, anthracite | <b>208.40 €</b> |

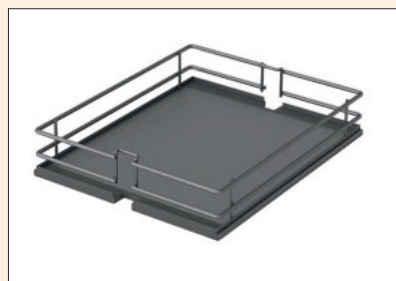

### VS TAL Larder Premea basket

- Storage elements for VS TAL Larder frame.
- basket width 250 mm for 300 mm cabinet width
  - basket width 350 mm for 400 mm cabinet width
  - basket dimensions 80 x 250/350 x 460 mm (H x W x D)
  - including attachment clip
  - load capacity max. 16 kg per basket
  - rail silver, shelf grey, thickness 8 mm
  - rail anthracite, shelf anthracite, thickness 8 mm

|                |                                   |                 |
|----------------|-----------------------------------|-----------------|
| <b>8037019</b> | 300 mm cabinet, 1 pc., silver     | <b>60.08 €</b>  |
| <b>8037020</b> | 300 mm cabinet, 4 pc., silver     | <b>239.83 €</b> |
| <b>8037157</b> | 300 mm cabinet, 1 pc., anthracite | <b>60.08 €</b>  |
| <b>8037158</b> | 300 mm cabinet, 4 pc., anthracite | <b>239.83 €</b> |
| <b>8037021</b> | 400 mm cabinet, 1 pc., silver     | <b>79.33 €</b>  |
| <b>8037022</b> | 400 mm cabinet, 4 pc., silver     | <b>312.61 €</b> |
| <b>8037159</b> | 400 mm cabinet, 1 pc., anthracite | <b>79.33 €</b>  |
| <b>8037160</b> | 400 mm cabinet, 4 pc., anthracite | <b>312.61 €</b> |



### Power-Move drive rod

- System component for opening support for VS TAL Larder.
- for 300 and 400 mm cabinet widths
  - max. 120 kg extension force
  - reacts to pressure or tension
  - simple installation on the existing pull-out
  - subsequent installation possible
  - 220 volt connection required

|                |      |                 |
|----------------|------|-----------------|
| <b>8037035</b> | grey | <b>617.14 €</b> |
|----------------|------|-----------------|



### VS TAL Gate

The VS Tal Gate impresses through maximum storage space, easy access and optimal overview. The VS TAL Gate sets new standards in convenience and design. Opening the revolving door automatically moves the cupboard contents towards the user in one go.

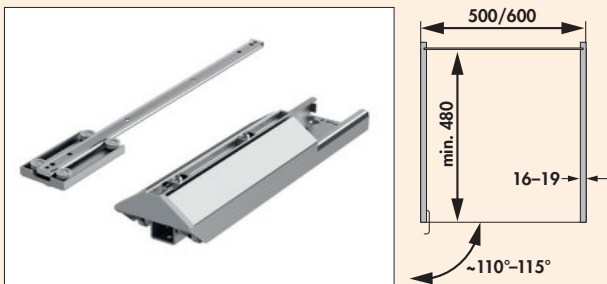

### VS TAL Gate runner

For larger cupboard drawer VS TAL Gate.

- top and bottom runner
- for cabinet with revolving door
- installation depth min. 480 mm
- load capacity max. 75 kg

**Please note:**

**Support frame and baskets need to be ordered separately!**

|                    |          |
|--------------------|----------|
| 8037036 silver     | 173.36 € |
| 8037161 anthracite | 173.36 € |

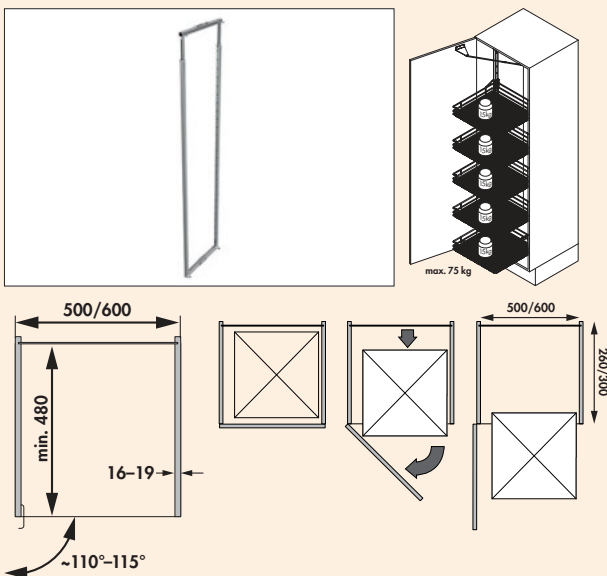

### VS TAL Gate frame

For larger cupboard drawer VS TAL Gate.

- cabinet widths 500 and 600 mm
- installation depth min. 480 mm
- installation height 1700 to 2140 mm
- support frame height telescopic
- tool-free mounting of the frame on the lower runner
- tool-free connection between the cam and support frame
- load capacity of the system max. 75 kg
- individual height adjustment of the 5 baskets
- can be mounted left or right

**Please note:**

**Runners and baskets need to be ordered separately!**

|   |          |
|---|----------|
| 8037043 500 mm cabinet, H 1700–1950 mm, up to 5 baskets, silver     | 199.41 € |
| 8037044 500 mm cabinet, H 1900–2140 mm, up to 5 baskets, silver     | 200.34 € |
| 8037162 500 mm cabinet, H 1700–1950 mm, up to 5 baskets, anthracite | 199.41 € |
| 8037163 500 mm cabinet, H 1900–2140 mm, up to 5 baskets, anthracite | 200.34 € |
| 8037047 600 mm cabinet, H 1700–1950 mm, up to 5 baskets, silver     | 200.34 € |
| 8037048 600 mm cabinet, H 1900–2140 mm, up to 5 baskets, silver     | 205.71 € |
| 8037164 600 mm cabinet, H 1700–1950 mm, up to 5 baskets, anthracite | 200.34 € |
| 8037165 600 mm cabinet, H 1900–2140 mm, up to 5 baskets, anthracite | 205.71 € |



### VS TAL Gate Premea basket

- Storage elements for VS TAL Gate larder cupboard drawer.
- basket width 400 mm for 500 mm cabinet width
  - basket width 500 mm for 600 mm cabinet width
  - basket dimensions 84 x /400/500 x 395 mm (H x W x D)
  - including attachment clip
  - load capacity max. 16 kg per basket
  - rail silver, shelf grey, thickness 8 mm
  - rail anthracite, shelf anthracite, thickness 8 mm
  - incl. door cam (only with basket set 4 pieces)

|                |                                   |                 |
|----------------|-----------------------------------|-----------------|
| <b>8037051</b> | 500 mm cabinet, 1 pc., silver     | <b>96.13 €</b>  |
| <b>8037052</b> | 500 mm cabinet, 4 pc., silver     | <b>377.31 €</b> |
| <b>8037166</b> | 500 mm cabinet, 1 pc., anthracite | <b>96.13 €</b>  |
| <b>8037167</b> | 500 mm cabinet, 4 pc., anthracite | <b>377.31 €</b> |
| <b>8037053</b> | 600 mm cabinet, 1 pc., silver     | <b>98.82 €</b>  |
| <b>8037054</b> | 600 mm cabinet, 4 pc., silver     | <b>395.29 €</b> |
| <b>8037168</b> | 600 mm cabinet, 1 pc., anthracite | <b>98.82 €</b>  |
| <b>8037169</b> | 600 mm cabinet, 4 pc., anthracite | <b>395.29 €</b> |

# STOREX® Storage systems

A variety of items perfectly sorted



 Tidy organising system    Page 560–563

# STOREX®

## Tidy organisation system

The complete solution for kitchen, bath or utility room



### **Tidy – the storage space concept**

- for tidy cupboards: everything neatly stowed and yet quickly to hand
- 60 cm wide cabinets of different heights can be individually equipped
- in just a few simple steps, components can quickly be changed, retrofitted or extended at any time
- various built-in modules that can be individually combined as required
- robust construction and durable materials for daily use
- made in Germany





### Tidy organising system

The comprehensive Tidy organising system uses the storage space available in the kitchen, bathroom or utility room as efficiently as possible. Above all in flats and houses without a basement or attic, special solutions are needed to create space for storing, washing and drying clothes.



### Tidy universal shelf

For various utensils (e.g. beverage crates, laundry baskets etc.). Pull-out function incl. pull-out rails.

- for 600 mm cabinet width
- corrosion-resistant coated steel sheet, white
- plastic parts white
- 68 x 568 x 510 mm (H x W x D)
- internal dimension: 445 x 500 mm (H x D)
- sidewall mounting (only suitable for 16 mm side walls)
- bearing capacity up to approx. 40 kg

8035216 white

265.88 €



### Tidy laundry basket

Laundry basket. Plastic.

- volume 41 liters
- 304 x 520 x 462 mm (H x W x D)

8035217 blue

107.82 €



### Tidy shoe rack

Built-in modules for storage of shoes.

- as attachment on universal shelf
- corrosion-resistant coated steel sheet, white
- 158 x 496 x 356 mm (H x W x D)

8035218 white

160.84 €



### Tidy utensils container

Utensils container. 2-fold with wall holder. Can be hooked in and removed.

- for 600 mm cabinet width
- for mounting to the outside of the cabinet or on the wall
- corrosion-resistant coated sheet steel, white
- plastic parts blue
- 241 x 436 x 198 mm (H x W x D)

8035200 white/blue

84.29 €



### Tidy broom/wipe holder

2-fold.

- corrosion-resistant coated steel sheet, white
- 262 x 137 x 352 mm (H x W x D)
- mounting with only four screws

8035219 white

81.18 €



### Tidy shelf

Shelf incl. dustpan and brush set.

- corrosion-resistant coated steel sheet, white
- 158 x 289 x 480 mm (H x W x D)
- mounting with only four screws

8035220 white

161.68 €



### Tidy clothes dryer attachment

For attaching to the outside of the cabinet or on the wall.

- for 600 mm cabinet width
- corrosion-resistant coated sheet steel, white
- folding
- 300 x 525 x 820 mm (H x W x D)

8035209 white

130.25 €



### Tidy wall bracket

For ironing board or household ladder.

- powder coated steel sheet, white
- 50 x 155 x 350 mm (H x W x D)

8035215 white

29.50 €



### Tidy laundry container pull-out 500

2-fold.

- for 500 mm cabinet width
- container volume 2 x 33 l
- metal parts sheet steel white, plastic parts white/light blue
- 545 x 462–468 x 528 mm (H x W x D)
- side wall mounting 16–19 mm
- with covered, damped self-closing mechanism including synchronised over-extension

8035211 white/light blue

397.98 €

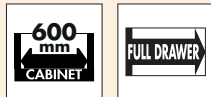

### Tidy laundry container pull-out S 600

- 2-fold.
- for 600 mm cabinet width
  - container volume 2 x 33 l
  - metal parts sheet steel white
  - plastic parts white/light blue
  - 545 x 562–568 x 448 mm (H x W x D)
  - side wall mounting 16–19 mm
  - sytem depth only 448 mm
  - **with covered, damped self-closing mechanism including synchronised over-extension**

8035213 white/light blue

456.39 €

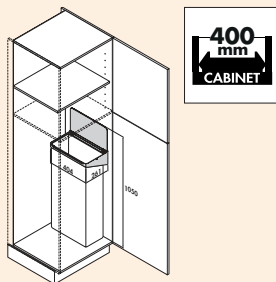

### Tidy bin bag holder

- Suspension device for bin bags or cloth bags.
- powder coated steel sheet
  - incl. cotton sack
  - installation in cabinets or outside on the cabinet wall
  - mounted with only 2 screws, recommended clearance height 1050 mm
  - 125 x 404 x 261 mm (H x W x D)

8035214 white

211.09 €

Cabinet  
equipment

# STOREX® Accessories

Things you always need



## Ladders

Supports heavy loads without  
being in the way

Page 567–568

## Miscellaneous

What also helps

Page 569–574





# STOREX® Ladders

Supports heavy loads  
without being in the way



Stepfix

Page 568

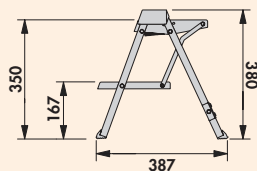

### Stepfix

Folding step. Two step hinged step especially designed for use in built-in kitchens. For storage behind front pull-outs or in the base area from a height of 100 mm.

- only 90 mm deep
- **load bearing capacity ca. 150 kg**
- **step height 380 mm**
- **dimensions installation 100 x 403 x 470 mm (H x W x D)**
- **dimensions product 380 x 403 x 387 mm (H x W x D) open**

8034030 aluminium

170.67 €



### Fastening bracket

As accessories for individual base pieces. Suitable for Stepfix. Due to clip-on technology, the base may be taken off.

8034032 chrome

40.17 €

# STOREX®

## Miscellaneous

What also helps



|                         |          |
|-------------------------|----------|
| ■ Stove protection grid | Page 570 |
| Decotop                 | Page 571 |
| Radios for installation | Page 572 |
| INTUBLU                 | Page 573 |

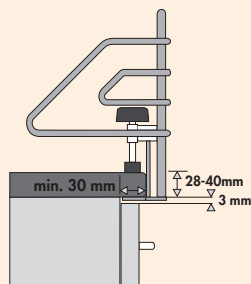

### Stove protection grid

Chrome. For simple mounting on the worktop in front of a 600 mm or 900 mm hob.  
— 175 x 140 mm (H x D)

|   |                 |
|---|-----------------|
| <b>8031005</b> for 600 mm cabinet, W 678 mm | <b>94.45 €</b>  |
| <b>8031008</b> for 900 mm cabinet, B 978 mm | <b>145.80 €</b> |





Galaxy Star

### Decotop

Inserted in a stainless-steel tray form granite surface Decotop. All types of granite are expressive and high quality. So everyone can find the type that suits them, and give their creativity free rein. And all that at a convincing price.

Our tip: Damaged work surfaces, e.g. due to burn marks, can be quickly and creatively remedied.



### Decotop 1

Granite section.  
 — dimensions 250 x 250 mm (incl. stainless-steel pan)  
 — cut-out dimensions 236 x 236 mm  
 — installation depth 13 mm

3012005 Galaxy Star

176.47 €



### Decotop 2

Granite section.  
 — dimensions 510 x 325 mm (incl. stainless-steel pan)  
 — cut-out dimensions 496 x 311 mm  
 — installation depth 13 mm

3012012 Galaxy Star

281.51 €



### Fonico 2022

DAB+/VHF-RDS radio. For installation from below. With fixed station memory, dimmable LCD display, LED workstation lighting on the underside, foldable stand, two alarm times, radio or alarm tone, sleep and snooze function, two kitchen timers, incl. mains adapter, power in operation 2 x 1 watt RMS.  
— 58 x 257 x 162 mm (H x W x D)

8031219 silver

127.73 €



### Fonico 2045

DAB+/FM-PLL radio. For installation from below. With pre-set memory, Bluetooth® function, music streaming from mobile phone, hands-free function, LED light strips (underside of the device), kitchen timer, two alarm times can be set, timer function, incl. AD/DC mains adapter 7 V 2A. Power consumption in operation 2 x 5 watt RMS.  
— 45 x 260 x 157 mm (H x W x D)

8031218 silver

163.03 €



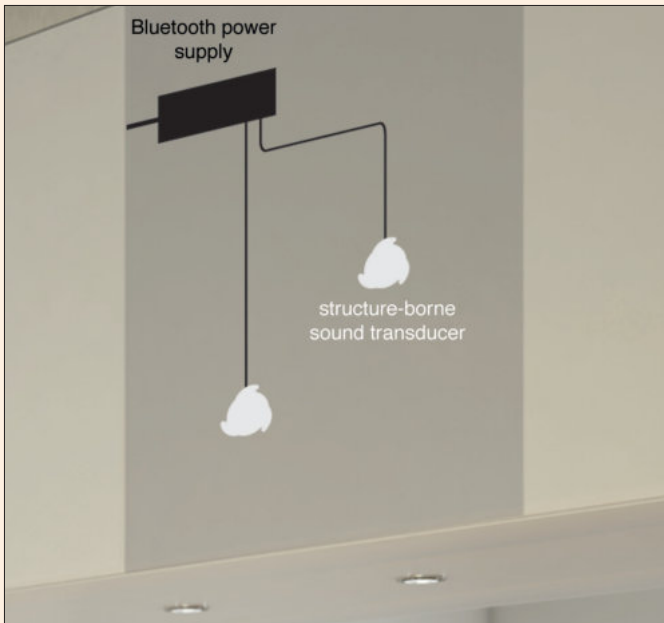

### INTUBLU

INTUBLU combines music and good design. This makes visible speakers a thing of the past, because from now on, furniture in the kitchen and living room play the music.

The sophisticated room concept is no longer interrupted by the appearance of inappropriate speakers.

The small Exciter elements can be easily integrated into kitchen drawers, cabinet doors or behind every mirror and played via smartphone, tablet or laptop in the best sound quality.



### INTUBLU

Built-in furniture speaker. With Bluetooth power supply and two structure-borne sound transducers. **For surfaces and furniture.** The invisible INTUBLU **speaker system** includes a Bluetooth receiver and two speakers that can be installed in furniture or on surfaces. The music is controlled and played by tablets, laptops or smartphones via Bluetooth.

Technical data:

- structure-borne sound transducer dimensions Ø 68 mm
- materia aluminium
- control via Bluetooth
- Bluetooth power supply dimensions 62 x 140 x 30 mm (H x W x D)
- radio frequency (unidirectional) 2.4. 2.83 MHz
- max. contrast load (ohm) 20 W
- max. range 10 m
- 3 screw-on points on the speaker
- appealing sound quality
- space-saving design
- cable length of the two structure-borne sound transducers 2 m | PVC connecting cable
- cable length Bluetooth power adapter 1.5 m | H03VVH2-F | 2 x 0.75 mm<sup>2</sup>
- no cables or speakers visible
- simple mounting by gluing or screwing

8031220 silver

326.05 €

Cabinet  
equipment