

MONTEC®

Fitting
materials



Fitting
materials

Precision

Naber[®]
...inspires!

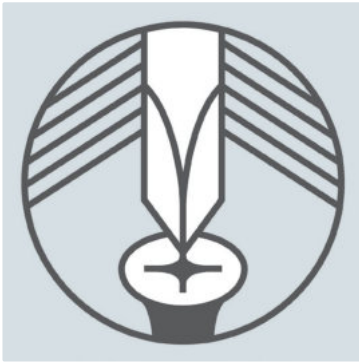

Always exactly the right solution for sink or faucet connections, electrical installation, pipe and line connections: MONTEC® has everything you need! And, at the same time, provides important installation aids.

Professionals know: the less space there is for sanitary and electrical installation, the cleverer the design of the distribution and fastening systems has to be. This is precisely where the MONTEC® range of installation materials comes into its own. With innovative product systems such as Flex-Frame®, the conveniently integrable mounting system for base cabinet sanitary installation, e.g. for kitchen islands. Or with the ready-to-connect Water Box water distribution tool. Or the power splitter MONTEC® Energy Box for hassle-free installation of additional built-in appliances without having to lay additional sockets in the furniture body.

Particularly for the special challenges that occur "behind the scenes" when planning and assembling kitchen islands, MONTEC® has quick and secure solutions. For pipes, connections and drains, with reduced service costs and fail-safe accessories!

MONTEC®

Fitting materials

Tested and ideally suited



■ MONTEC®
Accessories for sink connection
When you want the perfect connection Page 109–120



■ MONTEC®
Accessories for faucet connection
Secure connection in all situations Page 121–132



■ MONTEC®
Electrical accessories
You can rely on them Page 133–144



■ MONTEC®
Connecting materials
They keep their promise Page 145–154

MONTEC®

Accessories for sink connection

When you want the
perfect connection



■ Installation sets	Page 110–114
Odour trap	Page 114
Space saver	Page 114
Pipe odour trap	Page 114–116
Ball joint siphon	Page 115
Odour trap, flat	Page 115
Washing stand furniture siphon	Page 116
Pipe odour trap bathroom	Page 116
Siphon connection hose bathroom	Page 116
Drain fitting "Klick-Komfort"	Page 116
Flanged pipe	Page 117
Space-saving connector	Page 117
Waste bend 90°	Page 117
Adjusting pipe	Page 117
Extension pipe	Page 117
Screw connection	Page 117
Threaded hose connection	Page 118
Threaded nipple	Page 118
HT-rubber nipple	Page 118
Rubber collar for connecting pipes	Page 118
Rubber collar for bathroom connecting pipes	Page 118
HTEM drain pipe	Page 119
HTR transition pipe	Page 119
HTB bend	Page 119
HTMM double sleeve	Page 120
HTB-S bend continuously variable	Page 120
Reducer	Page 120
Lubricant	Page 120

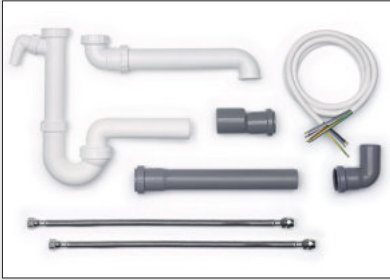

Installation set-1

Consisting of:

- 1 x ball siphon DN 40 (1051011)
- 1 x space-saving connector (1051017)
- 1 x HTB bend, DN 40/87.5° (1053014)
- 1 x HTEM drain pipe, DN 40, 250 mm long (1053002)
- 1 x HTR transition piece, DN 40/50 (1053031)
- 2 x stainless steel hoses with screw caps (5031028)
- 1 x connecting cable, 5 x 2.5 mm², 2000 mm long (7012004)

When purchasing 20 sets, these may be compiled individually.

1051022 set 8-part

77.40 €

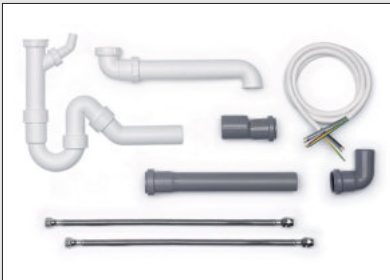

Installation set-1A

Consisting of:

- 1 x pipe odour trap DN 40 (1051003)
- 1 x space-saving connector (1051017)
- 1 x HTB bend, DN 40/87.5° (1053014)
- 1 x HTEM drain pipe, DN 40, 250 mm long (1053002)
- 1 x HTR transition piece, DN 40/50 (1053031)
- 2 x stainless steel hoses with screw caps (5031028)
- 1 x connecting cable, 5 x 2.5 mm², 2000 mm long (7012004)

When purchasing 20 sets, these may be compiled individually.

1050022 set 8-part

73.34 €

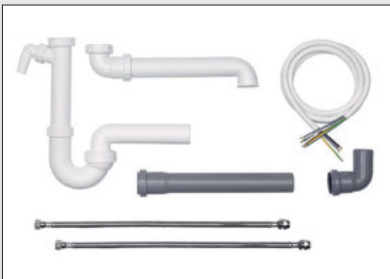

Installation set-8

Consisting of:

- 1 x ball siphon DN 50 (1051012)
- 1 x space-saving connector (1051017)
- 1 x HTB bend, DN 50/87.5° (1053020)
- 1 x HTEM drain pipe, DN 50, 250 mm long (1053006)
- 2 x stainless steel hoses with screw caps (5031028)
- 1 x connecting cable, 5 x 2.5 mm², 2000 mm long (7012004)

When purchasing 20 sets, these may be compiled individually.

1051072 set 7-part

75.80 €

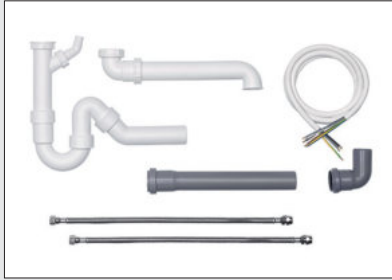

Installation set-8A

Consisting of:

- 1 x pipe odour trap DN 50 (1051004)
- 1 x space-saving connector (1051017)
- 1 x HTB bend, DN 50/87.5° (1053020)
- 1 x HTEM drain pipe, DN 50, 250 mm long (1053006)
- 2 x stainless steel hoses with screw caps (5031028)
- 1 x connecting cable, 5 x 2.5 mm², 2000 mm long (7012004)

When purchasing 20 sets, these may be compiled individually.

1050072 set 7-part

71.81 €

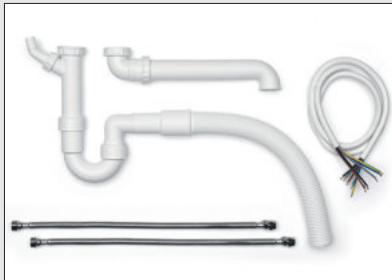

Installation set-2

Consisting of:

- 1 x odour trap (1052007)
- 1 x space-saving connector (1051017)
- 2 x stainless steel hoses 500 mm (5031028)
- 1 x connecting cable, 5 x 2.5 mm², 2000 mm long (7012004)

When purchasing 20 sets, these may be compiled individually.

1050028 set 5-part

67.14 €

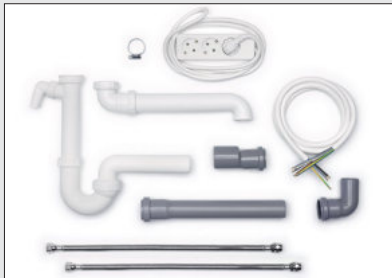

Installation set-3

Consisting of:

- 1 x ball siphon DN 40 (1051011)
- 1 x space-saving connector (1051017)
- 1 x HTB bend, DN 40/87.5° (1053014)
- 1 x HTEM drain pipe, DN 40, 250 mm long (1053002)
- 1 x HTR transition piece, DN 40/50 (1053031)
- 2 x stainless steel hoses with screw caps (5031028)
- 1 x connecting cable, 5 x 2.5 mm², 2000 mm long (7012004)
- 1 x triple power strip (7011087)
- 1 x hose clip 12 mm (4011044)

When purchasing 20 sets, these may be compiled individually.

1051063 set 10-part

99.69 €



Installation set-3A

Consisting of:

- 1 x pipe odour trap DN 40 (1051003)
- 1 x space-saving connector (1051017)
- 1 x HTB bend, DN 40/87.5° (1053014)
- 1 x HTEM drain pipe, DN 40, 250 mm long (1053002)
- 1 x HTR transition piece, DN 40/50 (1053031)
- 2 x stainless steel hoses with screw caps (5031028)
- 1 x connecting cable, 5 x 2.5 mm², 2000 mm long (7012004)
- 1 x triple power strip (7011087)
- 1 x hose clip 12 mm (4011044)

When purchasing 20 sets, these may be compiled individually.

1050063 set 10-part	95.53 €
----------------------------	----------------



Installation set-4

Consisting of:

- 1 x ball siphon DN 40 (1051011)
- 1 x space-saving connector (1051017)
- 1 x HTB bend, DN 40/87.5° (1053014)
- 1 x HTEM drain pipe, DN 40, 250 mm long (1053002)
- 1 x HTR transition piece, DN 40/50 (1053031)
- 2 x stainless steel hoses with screw caps (5031028)
- 1 x connecting cable, 5 x 2.5 mm², 2000 mm long (7012004)
- 1 x triple power strip (7011087)
- 1 x connecting cable 3000 mm (7011045)
- 1 x outlet valve (5031009)
- 1 x hose clip 12 mm (4011044)

When purchasing 20 sets, these may be compiled individually.

1051064 set 12-part	165.83 €
----------------------------	-----------------



Installation set-4A

Consisting of:

- 1 x pipe odour trap DN 40 (1051003)
- 1 x space-saving connector (1051017)
- 1 x HTB bend, DN 40/87.5° (1053014)
- 1 x HTEM drain pipe, DN 40, 250 mm long (1053002)
- 1 x HTR transition piece, DN 40/50 (1053031)
- 2 x stainless steel hoses with screw caps (5031028)
- 1 x connecting cable, 5 x 2.5 mm², 2000 mm long (7012004)
- 1 x triple power strip (7011087)
- 1 x connecting cable 3000 mm (7011045)
- 1 x outlet valve (5031009)
- 1 x hose clip 12 mm (4011044)

When purchasing 20 sets, these may be compiled individually.

1050064 set 12-part	161.93 €
----------------------------	-----------------

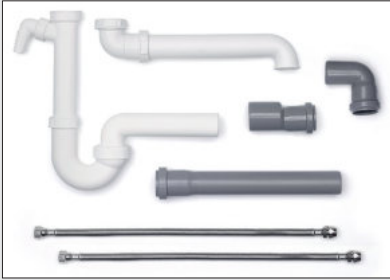

Installation set-5

Consisting of:

- 1 x ball siphon DN 40 (1051011)
- 1 x space-saving connector (1051017)
- 1 x HTB bend, DN 40/87.5° (1053014)
- 1 x HTEM drain pipe, DN 40, 250 mm long (1053002)
- 1 x HTR transition piece, DN 40/50 (1053031)
- 2 x stainless steel hoses with screw caps (5031028)

When purchasing 20 sets, these may be compiled individually.

1051014 set 7-part

61.46 €

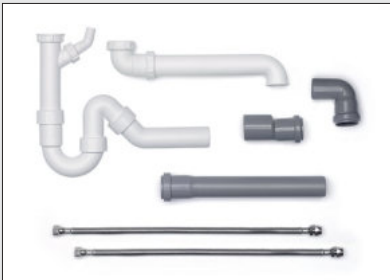

Installation set-5A

Consisting of:

- 1 x pipe odour trap DN 40 (1051003)
- 1 x space-saving connector (1051017)
- 1 x HTB bend, DN 40/87.5° (1053014)
- 1 x HTEM drain pipe, DN 40, 250 mm long (1053002)
- 1 x HTR transition piece, DN 40/50 (1053031)
- 2 x stainless steel hoses with screw caps (5031028)

When purchasing 20 sets, these may be compiled individually.

1050014 set 7-part

57.41 €



Installation set-6

For the washing machine connection.

Consisting of:

- 1 x reinforced hose 2000 mm (5031113)
- 1 x drain hose 1500 mm (5031109)
- 2 x hose connecting tube brass (5031114)
- 1 x hose clamp, 9 mm, Ø 12–22 mm (4011043)
- 1 x hose clamp, 9 mm, Ø 20–32 mm (4011044)

For orders of 20 sets, these can be put together individually.

5030010 set 6-part

67.32 €



Installation set-7

For washing machine. Connection extensions.

Consisting of:

- 1 x reinforced hose 2000 mm (5031113)
- 1 x drain hose 2500 mm (5031110)
- 1 x hose connection tube in plastic (5031111)
- 2 x hose clamp, 9 mm, Ø 20–32 mm (4011044)

On orders of 20 sets or more these can also be put together individually.

5030013 set 5-part	63.87 €
--------------------	---------

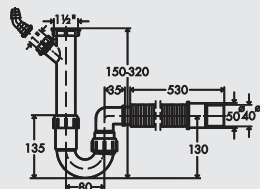

Odour trap 1, flexible

The flexible connection of this standard siphon solves almost any plumbing problem. With additional waste water hose connection for dishwasher or washing machine. Drain hose may be shortened.

1052007 Connecting sleeve Ø 40/50 mm	13.87 €
--------------------------------------	---------

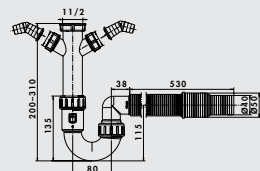

Odour trap 2, flexible

The flexible connection of this standard siphon solves almost any plumbing problem. With two appliance connections for a dishwasher or washing machine. Drain hose may be shortened.

1051161 Connecting sleeve Ø 40/50 mm	14.79 €
--------------------------------------	---------

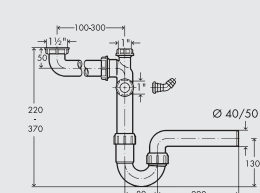
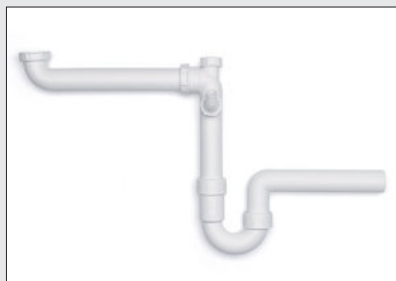

Space saver

Space saver without drain and spillover fittings. With additional waste water hose connection for dishwasher or washing machine.

– tested as per DIN EN274

1051001 1 1/2" x Ø 40 mm	21.43 €
1051002 1 1/2" x Ø 50 mm	21.43 €

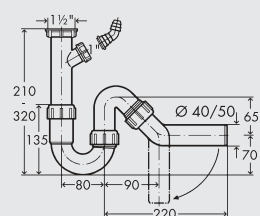
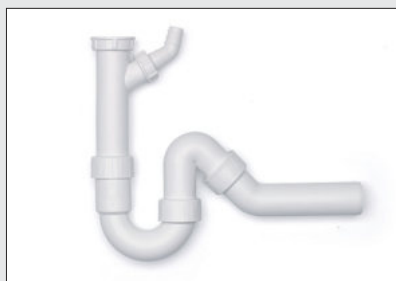

Pipe odour trap 1

The drain pipe may be swivelled by 90° and enables more variable routing of the drain pipe. With additional waste water hose connection for dishwasher or washing machine.

– tested as per DIN EN274

1051003 1 1/2" x Ø 40 mm	12.94 €
1051004 1 1/2" x Ø 50 mm	12.94 €

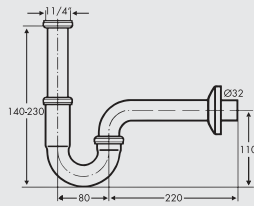

Pipe odour trap 4

Chrome-plated pipe odour trap for washing stands with greater adjusting range.
— tested as per DIN EN274

1051029 1 1/4" x 1 1/4" 35.46 €

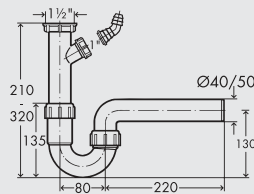

Pipe odour trap 2

For sinks with a level drain. With additional waste water hose connection for dishwasher or washing machine.
— tested as per DIN EN274

1051023 1 1/2" x Ø 40 mm 10.25 €

1051024 1 1/2" x Ø 50 mm 10.25 €

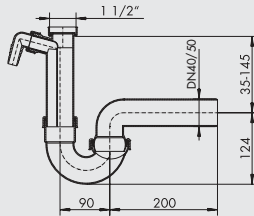

Ball joint siphon 1

The drain is variable in height and depth due to a ball joint and may therefore be optimally connected to the drain pipe connections even in close spaces. With additional waste water hose connection for dishwasher or washing machine.
— tested as per DIN EN274

1051011 1 1/2" x Ø 40 mm 15.71 €

1051012 1 1/2" x Ø 50 mm 15.71 €

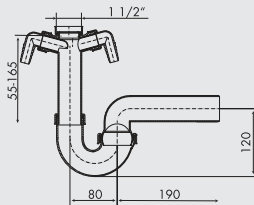

Ball joint siphon 2

The drain is variable in height and depth due to a ball joint and may therefore be optimally connected to the drain pipe connections even in close spaces. 2 additional angular spouts for waste water connection of a dishwasher and a washing machine.
— tested as per DIN EN274

1050011 1 1/2" x Ø 40 mm 20.76 €

1051019 1 1/2" x Ø 50 mm 24.03 €

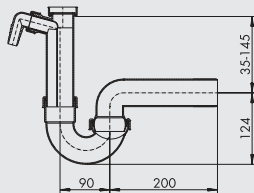

Ball joint siphon 3 super silent

The drain is variable in height and depth due to a ball joint and may therefore be optimally connected to the drain pipe connections even in close spaces. Additionally with a separate chamber for the waste water from the dishwasher or the washing machine, making it super-quiet.
— tested as per DIN EN274

1051013 1 1/2" x Ø 50 mm 20.50 €

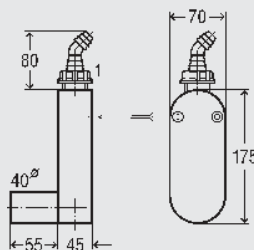

Odour trap, flat

For the drain hose of washing machines or dishwashers.

- wall mounting
- drain pipe horizontal
- fixing screws
- hose connection 45°
- tested according to DIN 19541

1051065 DN 40 white 54.29 €

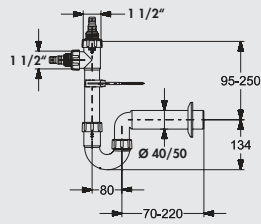

Pipe odour trap 5

For the drain hose of washing machines or dishwashers. With wall bracket (bracket, hanger bolt and pivot nut). Seals and rosette. Colour white.
— tested according to EN274

1051066	1 1/2" x Ø 40 mm	12.10 €
1051067	1 1/2" x Ø 50 mm	12.10 €

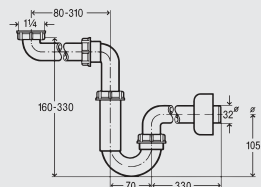

Pipe odour trap

For basins and bidets. Space saving.
— tested according to EN274
— 1 1/4" x DN 32

1051059	white	41.85 €
---------	-------	---------

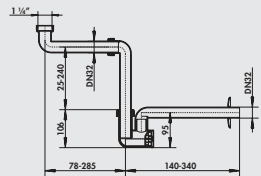
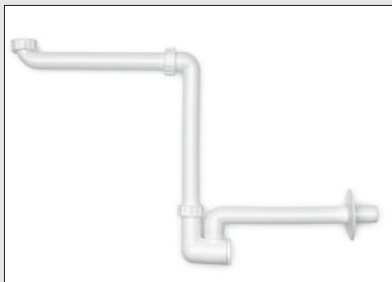

Washing stand furniture siphon

Extremely space-saving thanks to continuously adjustable rotating joints, especially for washing stand substructures and wheelchair accessible washing stands, with pull-out cleaning insert rosette.
— material polypropylene, highly impact resistant
— tested as per DIN EN274
— 1 1/4" x DN 32

1051052	white	65.80 €
---------	-------	---------

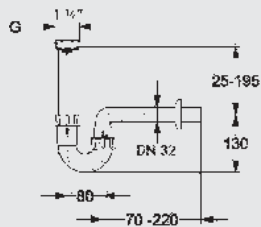

Pipe odour trap bathroom

Incl. drain pipe 240 mm long and height-adjustable immersion tube. Seals and rosette.
— 1 1/4" x DN 32
— tested as per DIN EN274

1051026	white	10.50 €
---------	-------	---------

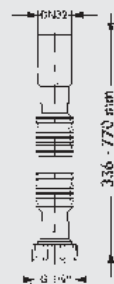

Siphon connection hose bathroom

— flexible and extendable as required
— 1 1/4"

1051071	white	6.22 €
---------	-------	--------

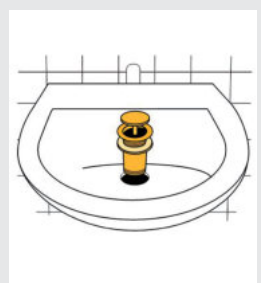

Drain fitting "Klick-Komfort"

— chrome plated brass
— suitable for basins
— closure Ø 63 mm
— 1 1/4"

1051069	without overflow, L 50 mm	45.88 €
1051070	with overflow, L 70 mm	55.97 €

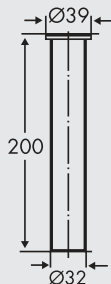

Flanged pipe, straight

– 32 x 200 mm (Ø x L)

1051038 chrome

9.92 €

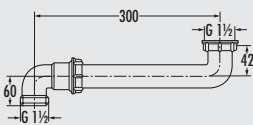
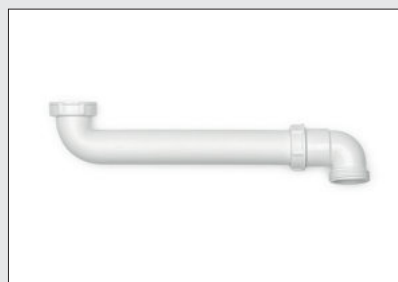

Space-saving connector

This fitting part enables movement of the siphon to the often unused space near the wall of the floor cupboard and under the sink and therefore saves space.

– threaded joint 1 1/2"

1051017 white

5.63 €

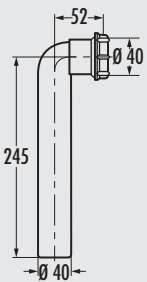

Waste bend 90°

With screw cap.

– 40 x 245 mm (Ø x L)

1051010 white

8.57 €

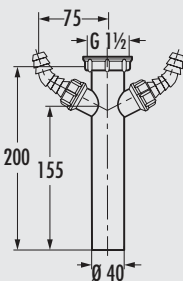

Adjusting pipe

With two threaded hose joints for connection of drain hoses of washing machines or dishwashers.

– L 200 mm

– 1 1/2"

– Ø 40 mm

1051018 white

8.32 €



Extension pipe

With screw cap.

– L 250 mm

– 1 1/2"

– Ø 40 mm

1051020 white

5.38 €

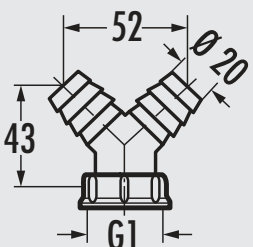

Screw connection

For connecting the washing machine or dishwasher drain hose – with double nozzle.

– version plastic, flat gasket

– thread 1

– for hose i. dia. 3/4", 19 mm

1051021 white

4.37 €

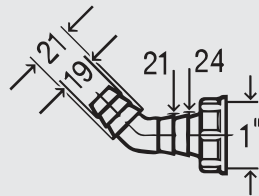

Threaded hose connection

- 45°
- plastic Ø 20–24 mm
- for waste water hose connection

1051062 white 2.02 €

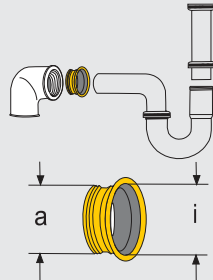

Threaded nipple

Black. Drain connector for chrome-plated brass and plastic siphons. For connecting to iron pipes.

1051045 for 1 1/2" x 32 mm, o 47 mm, i 30.5 mm 1.85 €

1051056 for 2" x 40 mm, o 58 mm, i 39 mm 3.70 €

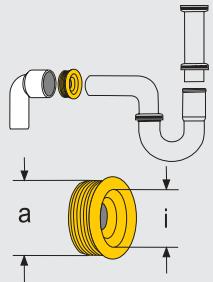

HT rubber nipple

Black. Nipple suitable for straight transition nozzles, siphon angles and HT-pipe. The outside diameter is decisive for sleeves and pipe diameters.

1051043 for 1 1/2", DN 40–50, o 54 mm, i 33 mm 3.11 €

1051057 for 2", DN 50, o 68 mm, i 42 mm 3.11 €

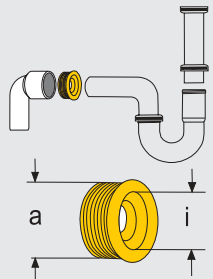

Rubber collar for connecting pipes

Black. Collar suitable for most siphon connections, especially for direct connection in roller cage sleeves for PVC connecting pipes, without using transition pieces.

1051053 for 1 1/2", DN 40–60, o 59 mm, i 33 mm 3.19 €

1053030 for 1 1/2", DN 40–50, o 50 mm, i 36 mm 3.61 €

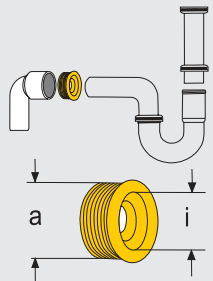

Rubber collar for bathroom connection pipes

Black. Collar suitable for most connecting bends, especially for direct connection to siphons.

1053032 for 1 1/4", DN 32–40, o 41 mm, i 26 mm 4.79 €

1053033 for 1 1/4", DN 32–50, o 50 mm, i 27 mm 6.81 €



HTEM drain pipe

Ready for assembly with one-sided plug-in sleeve and inserted rubber gasket, manufactured in PP, as per DIN 4102.

1053001	L 150, Ø 40 mm	2.18 €
1053002	L 250, Ø 40 mm	2.52 €
1053003	L 500, Ø 40 mm	3.11 €
1053004	L 1000, Ø 40 mm	4.62 €
<hr/>		
1053005	L 150, Ø 50 mm	2.69 €
1053006	L 250, Ø 50 mm	3.19 €
1053007	L 500, Ø 50 mm	4.37 €
1053008	L 1000, Ø 50 mm	5.80 €



HTR transition pipe

With inserted rubber gasket, manufactured in PP, as per DIN 4102.

1053031	NW 50/40	2.52 €
----------------	----------	---------------



HTR transition pipe short

With inserted rubber gasket, manufactured in PP, as per DIN 4102.

1053025	NW 50/40	2.52 €
----------------	----------	---------------



HTB bend

Standardised bend piece made of PP per DIN 4102.

1053009	angle 15°, Ø 40 mm	2.18 €
1053010	angle 30°, Ø 40 mm	2.18 €
1053011	angle 45°, Ø 40 mm	2.18 €
1053012	angle 67.5°, Ø 40 mm	2.18 €
1053014	angle 87.5°, Ø 40 mm	2.18 €
<hr/>		
1053015	angle 15°, Ø 50 mm	2.61 €
1053016	angle 30°, Ø 50 mm	2.61 €
1053017	angle 45°, Ø 50 mm	2.61 €
1053018	angle 67.5°, Ø 50 mm	2.61 €
1053020	angle 87.5°, Ø 50 mm	2.61 €



HTMM double sleeve

With inserted rubber gaskets, manufactured in PP, as per DIN 4102.

1053023 Ø 40 mm	2.10 €
1053013 Ø 50 mm	2.27 €



HTB-S bend continuously variable

Always the right angle, with just one bend, continuously variable from 0–87°.

1053028 angle 0–87°, Ø 50 mm	5.38 €
-------------------------------------	---------------

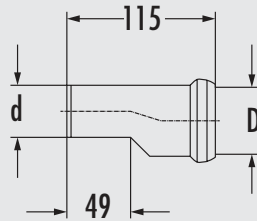

Reducer

With lip seal.
– 50/40 mm

1053019 white	2.94 €
----------------------	---------------



Lubricant

For HT pipes.

1053022 tube 150 ml	4.20 €
----------------------------	---------------

MONTEC®

Accessories for faucet connection

Secure connection
in all situations



Fitting
materials

Stainless steel hoses	Page 122
Water Box	Page 123–124
Flex-Frame®	Page 125–126
Corner valves	Page 127
Dirt filter Ecco 1	Page 127
Outlet valve	Page 127
Slanted device valve	Page 127
Sink duct	Page 128
Spacer disk	Page 128
Copper pipe chrome-plated	Page 128
Double screw connection	Page 128
Wall disk for copper pipe	Page 128
T-screw connection	Page 128
T-connector	Page 129
Hose burst protection	Page 129
Faucet hole plug	Page 129
Screw-in hole punch	Page 129
Aerator regulator wrench	Page 129
Pillar top wrench	Page 129
Deflector for hoses with shower head	Page 130
Adapter nipple	Page 130
Washing machine hose supply line	Page 130
Washing machine hose extension	Page 130
Hose clip	Page 130
Safety supply hose	Page 131
Drain hose	Page 131
Hose connecting tubes	Page 131
Backflow preventer nibble	Page 131
Reinforced hose	Page 131
Flow meter	Page 132

High safety

Especially pressure resistant due to close-meshed stainless steel braiding

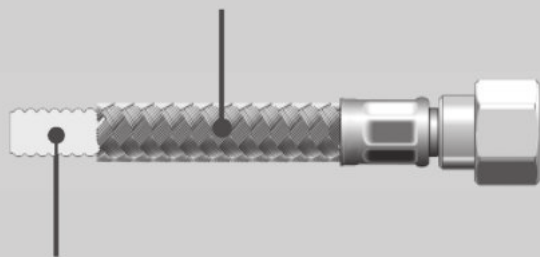

Hygienic

due to the inliner PE-RT material

Flexible sanitary hoses

Features:

- inliner (material PE-RT) with a strong 0.6 mm wall thickness
- high stability against buckling, consistent flow guaranteed
- tested for micro-biological limits (W 270), neutral to foods and odour-free (KTW-A)
- very flexible in installation, minimal bending forces
- high pressure stability due to high-quality stainless steel mesh
- high stability against stress cracks from the inliner to the connectors
- long-term stability against oxidative degradation (aging)
- usable with long-term loading
- very good temperature change properties
- all positive mechanical properties as per worksheet W 543 **DVGW** certified
- assembly and connection may be carried out as part of the activities of the "furniture specialist for specified activities" Module 2 sanitary technology (TÜV Rheinland)



Stainless steel hose

Sturdy, flexible water hose. The sheath made of stainless steel mesh and anti-slip stepped shoulder on the pipe connecting piece guarantees optimum functional properties.

- 3/8" squeeze-type threaded joint
- tested as per W 270 + KTW-A

5031001 L 300 mm, pipe connection 10 mm **9.58 €**

5031002 L 500 mm, pipe connection 10 mm **11.68 €**

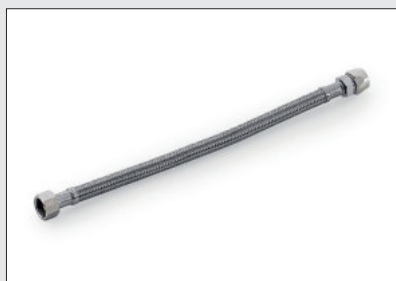

Stainless steel hose with 3/8" screw cap

Sturdy, flexible water hose. The sheath made of stainless steel mesh with 3/8" screw cap guarantees optimum functional properties.

- 3/8" squeeze-type threaded joint
- tested as per W 270 + KTW-A

5031017 L 300 mm **10.67 €**

5031018 L 500 mm **13.45 €**

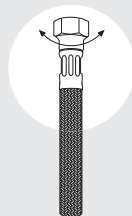

Flex-stainl. steel hose squeeze-type joint

Sturdy stainless steel mesh with rotating 3/8" squeeze-type threaded joint, therefore no hose twisting is possible (**twist-free**).

- tested as per W 270 + KTW-A

5031025 L 300 mm, pipe connection 10 mm **11.85 €**

5031026 L 500 mm, pipe connection 10 mm **14.79 €**

5031031 L 1000 mm, pipe connection 10 mm **29.58 €**

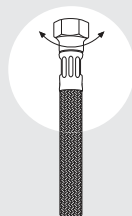

Flex-stainless steel hose screw cap

Sturdy stainless steel mesh with rotating 3/8" screw cap, therefore no hose twisting is possible (**twist-free**), with 3/8" squeeze-type threaded joint.

- Suitable for flexi-hose and extension of copper pipes.
- tested as per W 270 + KTW-A

5031027 L 300 mm **13.87 €**

5031028 L 500 mm **17.48 €**

5031034 L 1000 mm **34.87 €**

MONTEC®

Water Box



Fitting materials

The optimal solution for connecting multiple devices to the domestic water installation.

The Naber Water Box enables the simple connection of several water consumers (faucet, dishwasher, washing machine) to a supply point. This greatly facilitates the plumbing of the water connection of various appliances in the kitchen. The boiling water fittings, drinking water filters, water dispensers, fully automated coffee machines, etc. in modern kitchens are easily connected to the domestic water installation and supplied with water via the Naber Water Box.

The Naber Water Box makes the use of various angle and bonnet valves superfluous. All consumers are connected in a space-saving way to only one connection cube and centrally supplied.

The water is supplied via a 500 mm long flexible connection hose DN 10 with a 3/8" collar nut. This connects the on-site angle valve with the Naber Water Box. The kitchen faucet, dishwasher, washing machine and other devices with a fixed water connection can simply and easily be connected to the on-site cold water angle valve via the four remaining 1/2" connections of the Naber Water Box.

When installing pressure-resistant storage water heaters, the solid brass block on the appliance safety group provides a secure hold and, thanks to the flexible installation position, ensures sufficient gradient to the drainage point of the siphon. Four mounting holes ensure good attachment to the kitchen furniture or walls.



The connection of the Water Box to an on-site angle valve may be done within the scope of the activities of the "furniture specialist for specified activities" module 2 sanitary technology (Modulreihe TÜV Rheinland Akademie www.tuv.com) in relation to kitchen or furniture assembly.

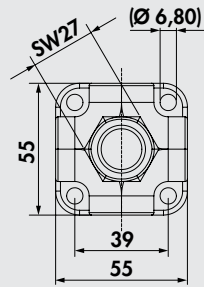

Water Box



For connecting several water consumers to one supply point.
Individual mounting position possible due to flexi-hose.

- connection 1 x ½" internal thread open, 3 x ½" internal thread closed with sealing plugs
- incl. 500 mm 3/8" flexible stainless steel hose (connections: ½" AG x 3/8" union nut)
- 55 x 55 x 55 mm (H x W x D)
- max. water flow rate up to 27 l/min at 3 bar
- material: brass CB 757S, DVGW certified and suitable for drinking water
- assembly and connection may be carried out as part of the activities of the "furniture specialist for specified activities" Module 2 sanitary technology (TÜV Rheinland)

5031035 chrome plated

121.01 €

MONTEC®

Flex-Frame®

Perfect installation of all connections for kitchen islands

Kitchen islands are popular as attractive eye-catchers in the centre of spacious, high-quality living kitchens. However, there are special challenges "behind the scenes" during planning and installation. If pipes, connections and drains are positioned on the floor on site, installation is awkward and complicated.

The clearly better solution is called **MONTEC® Flex-Frame®**. With this, Naber offers a safe and quick way to fit water connections and all other components intended for installation in the base cabinet.

The basis of **Flex-Frame®** is a mounting frame consisting of two fixing brackets with a sliding middle piece. The fastening via slotted holes allows for continuous adjustment. On-site wall disks for the connections and drains can be firmly and effortlessly fitted. Especially convenient: this perfect and clever installation aid is flexibly adapted to the standard dimensions of kitchen base units.



Fitting materials



Cleanly and clearly mounted: cold and hot water, sink drain, surface-mounted socket, connection for drinking water pipe (e.g. for a coffee machine with a fixed water connection or a refrigerator with an ice cube maker).

Naber
FLEX FRAME®
↔

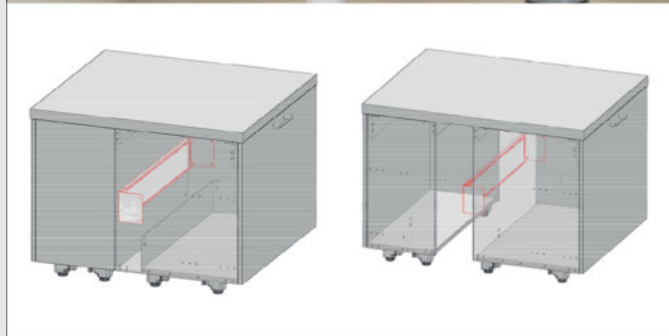

Flex-Frame®

When installing water connections, the kitchen fitter normally finds pre-installed corner valves on the wall. For the water outlet, the discharge connection is usually located next to the corner valves.

If a kitchen island is planned, the situation is different. Here the pipes and waste outlets are positioned on the floor and are very difficult to reach.

Flex-Frame® offers the fitter a neat solution. In order to cover all common widths of kitchen furniture, the product consists of two brackets each, onto which a sliding centre piece is placed. Slotted holes in the centre piece allow flexible length adjustment of the Flex-Frame® to the standard dimensions of kitchen base units. With the aid of the Flex-Frame®, an additional mounting level is created, which makes it possible to position all the components freely and safely.

Mounting position of the Flex-Frame®

Depending on the planning position of the sink cabinet, the Flex-Frame® can be mounted inside the base cabinet or outside it in the installation space behind. This provides more space in tight installation situations, e.g. for waste separation systems, water filters or under-sink devices.

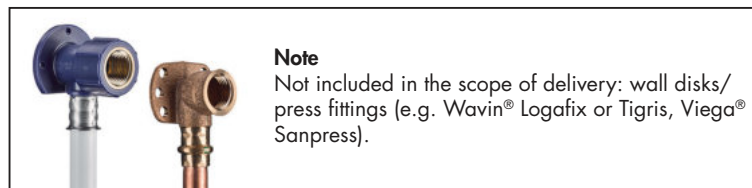

Note
Not included in the scope of delivery: wall disks/
press fittings (e.g. Wavin® Logafix or Tigris, Viega®
Sanpress).

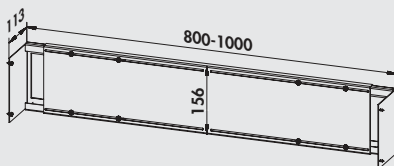
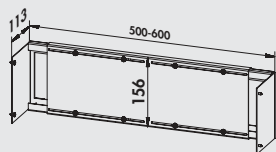
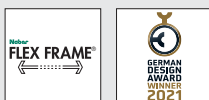

Flex-Frame®

Mounting frame sheet steel, white (RAL 9010), telescopic.

- for a clear mounting level in kitchen base units
- installation options for commercially available angle valves (1/2", 3/8") in connection with wall discs/press fittings for surface-mounted sockets, pipe clamps for HT-pipes, Naber Water Box, etc.
- suitable for cabinet widths 500/600 or 800/900/1000 mm (16+19 mm body thickness)
- high-quality appearance due to scratch- and impact-resistant powder coating
- easy to install due to prior fixing of the frame to the required cabinet width

5031037 for cabinet widths 500/600 mm **95.80 €**

5031038 for cabinet widths 800/900/1000 mm **119.33 €**

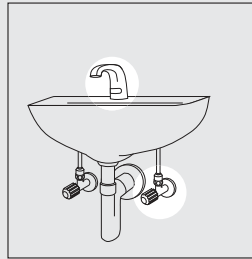

Corner valve

Connecting fitting with self-sealing installation thread, including extension, push-on collar chrome-plated.
— tested as per DIN 3227

5031004 1/2", chrome 14.96 €

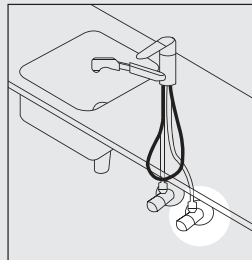

Corner valve COMFORT

Connecting fitting with extension, push-on collar chrome-plated, high tensile brass taper, squeeze-type threaded joint with length compensation and self-sealing thread.

— noise classification I
— tested as per DIN 3227

5031029 1/2", chrome 16.13 €

5031003 3/8", chrome 19.66 €

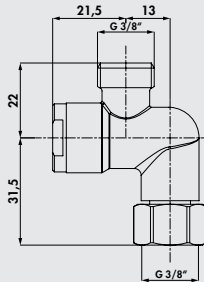

Dirt filter Ecco 1

For corner valves DN 10. With filter insert and removable screw. Protects the cartridge against ingress of dirt. For high-pressure faucets two filters are required, for low-pressure faucets, only one filter.

5031005 3/8", chrome 28.99 €

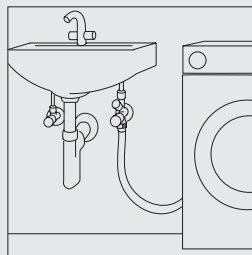

GA corner valve 2

Chrome-plated fitting for connection of dishwashers and washing machines, with self-sealing thread, with return flow inhibitor, length compensation connection, crown grip and push-on collar.

5031030 1/2", chrome 57.73 €

5031006 3/8", chrome 73.45 €

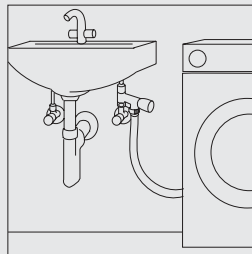

Outlet valve

For corner valve connection, with crown grip and length compensation connection, incl. return flow inhibitor.

— suitable for copper pipe 10 mm

5031009 3/8", chrome 53.61 €

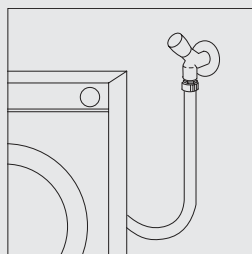

Slanted device valve

With grease chamber upper part, threaded hose connection and return flow inhibitor.

5031032 1/2", chrome 52.94 €

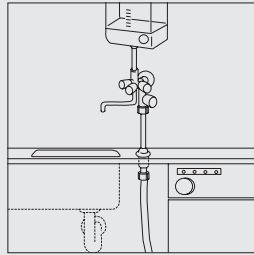

Sink duct

For reliable sealed connection of water supply pipe and sink/mixer fitting. An adjusting range of 70 mm enables the use of even very thick worktops or thick-walled moulded sink parts. With flexible hose connection on the valve side.
Copper pipe Ø: 12 x 500 mm and 3/4" screw cap with gasket and hose thread 1/2" x 12 mm.

5031014 Ø 12 mm, chrome

74.37 €

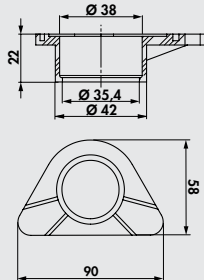

Spacer disk

Optional accessories for all faucets. This plastic disc provides for extra stability especially under stainless steel sinks for additional stability.

5031020 white

5.46 €



Copper pipe chrome-plated

Packaged in rings of 5000 mm.

5031010 L 5000 mm, Ø 10 mm

100.84 €



Double screw connection

With two squeeze-type threaded joints, chrome.
Only available in PU of 20 pieces.

5031016 3/8" x 3/8", Ø 10 mm, price per PU

131.93 €



Wall disk for copper pipe

Chrome with squeeze-type threaded joint.

5031036 1/2", Ø 10 mm

32.10 €



T-screw connection

Chrome with 3 squeeze-type threaded joints.

5031039 3/8" x 3/8" x 3/8", Ø 10 mm

15.04 €



T-connector

For connection to washing machines and dishwashers.
2 external threads 3/4" and 1 internal thread 3/4".

5031046 chrome

36.97 €



Hose burst protection



For 1/2" hoses, internal and external threads 3/4" and closing function in case the connecting hose bursts or slides off. Reacts to water pressure up to a maximum of 18 l/min. flow volume.

5031051 chrome

27.23 €



Faucet hole plug

The faucet hole plug made of plastic closes an existing, but unused hole for mixer fittings in the sink.

— plug Ø 50 mm

1051008 chrome

12.52 €



Screw-in hole punch

Simple but effective punch device for creating holes in stainless steel sinks, sturdy and clean precision workmanship for constant use.

Makes holes in iron and steel plates up to a thickness of 2 mm and VA-Nirosta steel plates up to a thickness of 1.5 mm.

1051016 Ø 35 mm, M 12 x 1.5

88.24 €

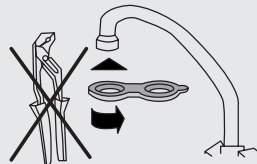

Aerator regulator wrench

Heavy-duty aerator regulator wrench in extremely tough, fibre-reinforced plastic. Suitable for most aerator regulators.

5031047 red

4.54 €



Pillar tap wrench

Chrome Vanadium special steel, very durable, swivelling sliding bar, with swivelling, spring-loaded jaw for turning to left and right. For easy installation and removal of faucet screw connection which is hard to reach.

— size 3/8"-1 1/4"

— clamping range 10-32 mm

5031048 L 235 mm

46.72 €

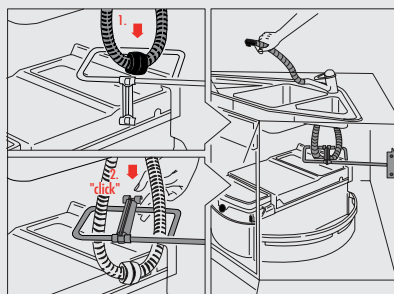

Rondo plus deflector for hoses with shower head

For all common hose fittings with shower head.

- easy installation by screwing to the floor cupboard
- forced routing of the hose in the remaining free spaces, right, left, rear, top
- installed appliances are not impaired in their function
- metal yoke, powder coated with epoxy resin
- **optimal accessory for Rondo plus**

8011175 white 19.83 €

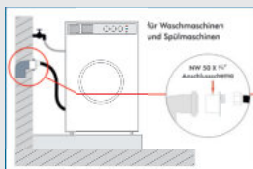

Adapter nipple

Drain hose, firmly screwed.

- for washing machines, dishwashers and effluent pumps
- no slipping out of the drain hose
- permanent and tight connection
- universally applicable
- adapter nipple NW 50 x 3/4"
- hose nozzle with 3/4" union nut

5031121 white 16.39 €



Washing machine hose supply line

Washing machine/dishwasher hose supply line. With a straight screwed joint 3/4" and an angled screwed joint 3/4", grey, heat-resistant up to max. 25 °C, only for connection to cold water supply.

– **operating pressure max. 10 bar**

5031100 L 1500 mm 10.42 €

5031102 L 2500 mm 16.72 €

5031103 L 3500 mm 21.26 €



Washing machine hose extension

Washing machine/dishwasher hose extension, PVC grey, one straight plastic joint 3/4" and one completely assembled external thread 3/4", heat-resistant up to max. 25 °C.

– **operating pressure 10 bar**

5031104 L 1500 mm 9.50 €

5031105 L 2500 mm 13.95 €



Hose clip

Galvanised steel with hexagon screw.

- aluminium coloured
- band width 9 mm

4011043 1/2" 3/4", nominal width 12–22 mm 2.10 €

4011044 3/4" 7/8", nominal width 20–32 mm 2.44 €



Safety supply hose

For washing machines and dishwashers, valve closes automatically when the hose bursts, with straight joint and angle joint.

- maximum pressure 10 bar
- maximum water temperature 90 °C

5031106	L 1500 mm	60.67 €
5031107	L 2000 mm	69.33 €
5031108	L 3000 mm	91.60 €



Drain hose

Plastic spiral drain hose with hanger yoke, with moulded, elastic sleeves on both sides. Particularly suitable for the waste connection of the devices in fitted kitchens. The hose cannot snap off when the device is pushed under the worktop. 19 mm and 22 mm connecting sleeves, grey.

5031109	L 1500 mm	8.74 €
5031110	L 2500 mm	11.68 €



Hose connecting tube 3/4", plastic

Suitable for the drain hose 5031109 and 5031110.

5031111	L 75 mm, Ø external 19 and 22 mm	2.35 €
---------	----------------------------------	--------

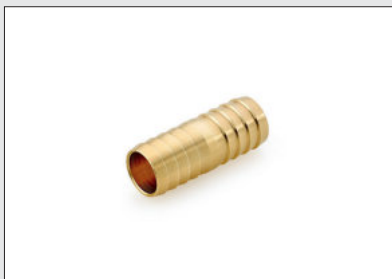

Hose connecting tube 3/4", brass

Suitable for the drain hose 5031109 and 5031110.

5031114	L 53 mm, Ø 19 mm	5.38 €
---------	------------------	--------



Backflow preventer nipple 3/4"

Backflow preventers protect drinking water pipes against the unwanted backflow of used water according to DIN EN 61770.

- for white appliances according to KTW-BWGL
- brass
- backflow preventer nipple internal thread 3/4" x 3/4" external thread to prevent backflow of water in dishwashers, washing machines and similar appliances

5031119	IG/AG 3/4"	23.11 €
---------	------------	---------



Reinforced hose

Washing machine hose with stainless steel mesh, one side with 3/4" external thread, the other side with screw cap and 3/4" internal thread. Operating pressure: 10 bar, burst pressure: 80 bar, heat resistance: max. 90 °C

5031112	L 1000 mm	31.26 €
5031113	L 2000 mm	48.15 €
5031116	L 3000 mm	67.90 €



Flow meter

Measuring beaker. Plastic. For flow measurement. For measuring the water flow rate in low-pressure storage tanks.

Note: the water flow rate should not exceed 4.5-5 l/min!

In extreme cases, a water flow rate that is too high can cause the boiler to burst.

6011045 red

59.92 €

MONTEC®

Electrical accessories

You can rely on them



Energy Box	Page 134–135
Kitchen connection box	Page 136
Connection box	Page 136
Evoline® Plug	Page 137
Flat plug	Page 138
Triple power strip	Page 139
Earthing contact plug	Page 139
Angled earthing contact plug	Page 139
Adapter for Swiss plug	Page 139
Protective contact box coupling	Page 139
Spiral connection line	Page 139
Connection line	Page 140
Connecting cable	Page 140
Line cords	Page 140
Stove connecting box	Page 141
Vario energy distributor	Page 141
Wago connecting clamp	Page 141
Wago feedthrough terminal	Page 142
Duct tape	Page 142
Moveable flange	Page 142
Cable duct	Page 142
Cable feed-through	Page 142
Rocker switch	Page 143
Earthed plug sockets	Page 143
Cover frames	Page 143
Flush mounted boxes	Page 143–144

MONTEC® Energy Box

Connection of hob, oven or dishwasher made easy

The assembly aid for the Naber kitchen. It's used when the hob and oven are not installed as one appliance. You also save space in assembly. A mechanical pull-off protection gives the plug a good hold in the connection box.

The four-core output line is intended as a permanent connection to hobs with a **maximum** power consumption of **2 x 3680 W**. The three-core output line with earthing contact coupling is intended exclusively for the connection of a plug-in oven/dishwasher with a maximum power consumption of **1 x 3680 W**.

Max. capacity: 11 KW (with symmetrical distribution)



Self-extinguishing material according to UL 94 (FR). In case of fire, this plastic will stop burning within a short time after removal of the ignition source (self-extinguishing).



General safety regulations

- Before using or operating the Energy Box, always read the instructions. The product may **ONLY** be connected by a qualified electrician.
- The Energy Box corresponds to protection class IP20 and is **NOT** suitable for use in wet rooms. The installation has to be carried out with the appropriate protection.
- After inserting the connection cables into the Energy Box, check the mechanical locking of the plug connections.
- Transportation or improper use may cause damage to the device. **In this case** do not open the device, do not operate the device, replace the damaged device.
- In case of failure to follow the instructions, the manufacturer's warranty ceases to apply.

Connection input (for connection to the hob connection socket)

1 x permanent connection cable – 2.0 m, 5G2,5 mm² with ferrules – max. capacity 11 KW (3-phase)

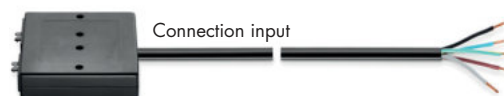

Dishwasher/oven

1 x cable 2.0 m, 3G1,5 mm² – page 1: plug EPN1104 – page 2: earthing contact coupling – max. capacity 3680 W (1-phase)



Induction field/hob

1 x cable 2.0 m – 4G2,5 mm² – page 1: plug EPN1204



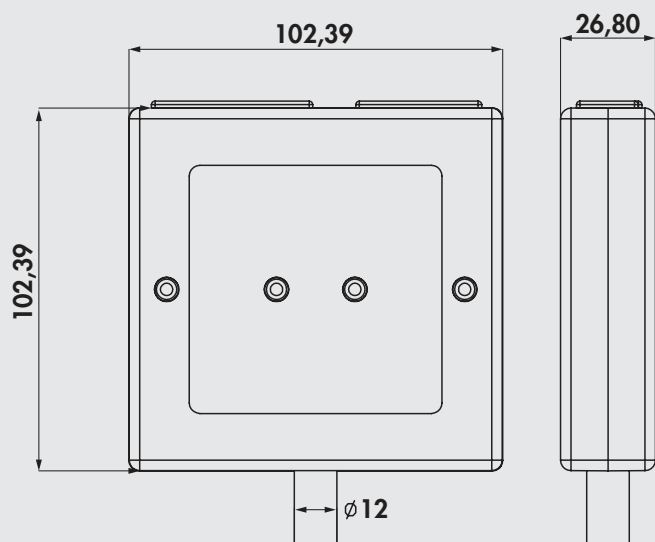

Energy box



Technical specifications:

- input voltage 400 V
- output voltage 4- pin (2-phase) 400 V
- output voltage 3- pin (1-phase) 230 V
- current max. 20 A
- tested according to IEC 60670-1 (DIN EN 60670-1), IEC 60670-22 (DIN EN 60670-22) and IEC 61535 (DIN EN 61535)
- material: self-extinguishing according to UL 94 (FR). In case of fire, after removal of the ignition source, this plastic will stop burning within a short time (self-extinguishing)
- construction: the housing is screwed and must not be opened by unauthorised persons
- dimensions of the box: 102 x 105 x 27 mm (H x W x L)
- protection type for the entire product IP20
- material: plastic

Calculation of the power requirement of the energy box:

- total power requirement of the cooker socket: 11 KW (with symmetrical distribution)
- hob power (4-pin connection): max. 7360 W (2-phase)
- oven power (3-pin connection): max. 3680 W (1-phase)

The use of a table socket to connect multiple consumers via a box coupling is not allowed for safety reasons.

If the induction hob already has a fixed cable, its use is compulsory. In this case, disconnect the 4-pin connector from the preassembled cable of the energy box and attach to the existing cable of the induction hob.

7012050 per 2 m cable length	115.97 €
7012051 per 5 m cable length	180.67 €
7012052 5 m/2 m (supply line) cable length	167.23 €
Optional accessories	
7012053 Adapter cable, 10 m, 3 x 1,5 mm ²	71.43 €

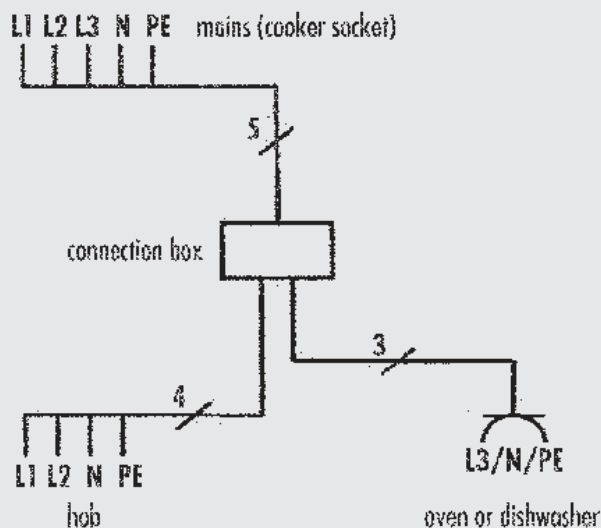

Kitchen connection box



The practical electrical kitchen connection is already equipped with all the necessary connecting cables for hob, oven, dishwasher or induction fields. The kitchen electric appliances can simply be connected from the cooker socket and the electrical connection implemented in an easy and space-saving manner.

Technical specifications:

- input voltage 400 V
- preliminary fuse max. 16 A
- cable and socket tested according to IEC 60670-1 (DIN EN 60670-1), IEC 60670-22 (DIN EN 60670-22) and IEC 61535 (DIN EN 61535)
- construction: The socket housing is screwed and sealed against unauthorised opening. This prevents any interference in the wiring. The internal wiring is printed on a label.
- grey distribution box 45 x 95 x 95 mm (H x W x L)

Calculation of the connection value of the kitchen connection box:

- total connected value cooker socket 11 KW (given symmetrical distribution)
- hob power (4-pole connection) max. 7360 W (2-phase)
- oven power (3-pole connection) max. 3680 W (1-phase)

The device corresponds to protection class IP20 and is not suitable for use in wet rooms. Connection and commissioning may only be carried out by a qualified electrician.

For safety reasons, a power strip should not be used to connect several electricity consumers via the box coupling.

7012017	each 1.8 m cable length, white	77.31 €
7012018	each 4.8 m cable length, white	114.29 €
7012019	4.8 m/1.8 m (supply line) cable length, white	97.48 €



Connection box



Mounting box for joining connecting cables. 16 entries, 3 bottom entries with self-sealing, soft insertion membranes. Tool for opening the cable entry not required, sealing range 2–14 mm. With external mounting straps.

- conductor cross section: 2.5 mm²
- rated insulation voltage AC: 400 V
- total number of entries: 19
- protection class: IP55 – acc. DIN EN 60670 (VDE 0606)
- equipment: screw terminal 5-pole 2.5 mm²
- 85 x 130 x 37 mm (H x W x D)

7011089	grey	11.85 €
---------	------	---------



Evoline® Plug

The innovative flat plug which gives you more space! Thanks to its flat design, furniture can easily be positioned closer to the wall.

With the aid of the extended grip element, you can easily lever the plug from the socket without applying much force.

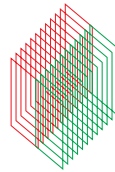

Ausgezeichnet mit dem 1. Preis
11. Designpreis des Landes
Nordrhein-Westfalen 2009
Universal Home: Product Design



Evoline® Plug



Loose flat plug, **only 5 mm deep**. Wherever space is very limited, the Evoline® Plug is in its element.
— 3680 W/16 A

7011069 white **20.17 €**



Extension cable with Evoline plug connector



With Evoline® plug connector and appliance plug socket, 3 x 1.5 mm² wired.
— line H05VV-F3 x G 1.5 mm²
— 3680 W/16 A

7011068 L 500 mm, white **32.02 €**

7011067 L 1000 mm, white **34.03 €**

7011066 L 2000 mm, white **43.36 €**



Triple power strip with Evoline® plug connector



250 V, sockets at a slant 45°, 3000 mm mains connection line, with Evoline® plug connector.
— line H05VV-F3 x G 1.5 mm²
— 3680 W/16 A

7011065 L 3000 mm, white **46.13 €**



Flat plug

The innovative flat plug solves an old problem: Furniture or equipment can now be pushed very close to the wall, because the plug has an extremely flat construction. But even in normal sockets it fits flat against the wall and is thus a small design object for your kitchen!

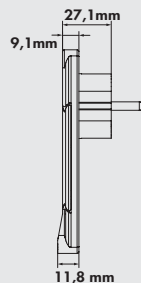

Flat plug



Flat plug, loose for the screw mounting.

Only 12 mm deep, extremely flat for reliable contact in the smallest space.
– 3500 W/16 A

7012020 white

19.33 €



Connection line with flat plug



Flat plug and connector (device socket), fully assembled.

– line H05VV-F3 G x 1.5 mm²
– 3500 W/16 A

7012021 L 500 mm, white

27.14 €

7012022 L 1000 mm, white

29.66 €

7012023 L 2000 mm, white

37.14 €



Triple power strip with flat plug



Flat plug and 3-fold power strip 45°, 3000 mm mains connection line, ready-made.

– line H05VV-F3 x G 1.5 mm²
– 3500 W/16 A

7012024 white

42.35 €



Triple power strip



Sockets slanted by 45°, with angled safety plug.
 – line H05VV-F3 x G 1.5 mm²
 – capacity max. 3500 watts

7011058 L 1400 mm mains connection line **16.22 €**

7011087 with increased contact protection, L
 3000 mm mains connection line **23.03 €**



Earthing contact plug



With integrated strain relief and central line connection.
 – capacity max. 3500 watts

7011021 white **3.53 €**



Angled earthing contact plug



With integrated strain relief and central line connection.
 – capacity max. 3500 watts

7011040 white **4.87 €**



Adapter for Swiss plug

This adapter from two-pin earthed plug to Swiss plug turns a two-pin earthed plug into a CH-compliant connection.

- black
- protection type IP20, design approved by Electrosuisse
- after fitting, the adapter can no longer be removed

7011042 up to max. 16 A/250 V **18.32 €**

7011027 up to max. 10 A/250 V **15.71 €**



Protective contact box coupling



- 2-pole,
- max. load 3500 W
- impact-proof

7011059 white **6.97 €**



Spiral connection line



With angled safety plug and sleeve coupling, expandable from 0.6–2.75 m.

- line H05VV-F3 x G 1.5 mm²
- capacity max. 3500 watts

7011044 white **73.61 €**



Connection line



With angled safety plug and sleeve coupling.
— line H05VV-F3 x G 1.5 mm²
— capacity max. 3500 watts

7011063	L 2000 mm, white	13.19 €
7011045	L 3000 mm, white	17.23 €
7011046	L 5000 mm, white	23.19 €

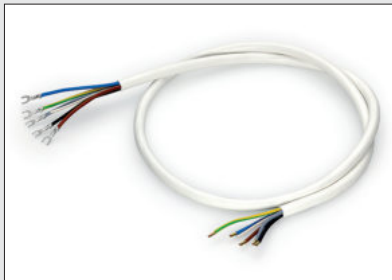

Connecting cable 1



Stripped, bared, with wire terminating sleeves and lugs.
(incl. copper surcharge)

7012006	L 2000 mm, 5 x 1.5 mm ²	16.05 €
7012007	L 1500 mm, 5 x 2.5 mm ²	18.32 €
7012008	L 2000 mm, 5 x 2.5 mm ²	20.76 €

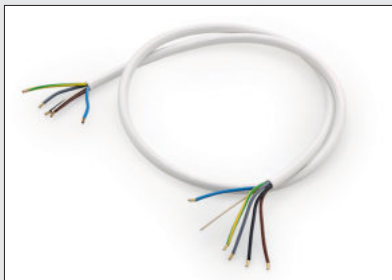

Connecting cable 2



Stripped, bared, with wire terminating sleeves on both sides.
(incl. copper surcharge)

7012001	L 1500 mm, 5 x 1.5 mm ²	12.86 €
7012002	L 2000 mm, 5 x 1.5 mm ²	15.21 €
7012003	L 1500 mm, 5 x 2.5 mm ²	16.72 €
7012004	L 2000 mm, 5 x 2.5 mm ²	17.06 €
7012013	L 3000 mm, 5 x 2.5 mm ²	27.48 €
7012014	L 5000 mm, 5 x 2.5 mm ²	56.55 €



Connecting cable on reel



— line H05VV-F3 x G 1.5–2.5 mm² (incl. copper surcharge)
— 1 reel 50 m

7012011	3 x 1.5 mm ²	191.60 €
7012010	5 x 2.5 mm ²	378.15 €



Line cords



With moulded angled safety plug. (incl. copper surcharge)
— line H05VV-F3 x G 1.5 mm²

7011061	L 2000 mm	11.60 €
7011062	L 3000 mm	13.11 €



Universal stove connecting box



For surface or flush mounting as per VDE 0606.

- claw-type holder
- cover cap with snap-in closure
- large connecting space due to positioning of the terminals outside of the flush mounted box
- support frame for screw connection on 58-gauge and 70-gauge switch box or dowel fixing
- covered double clamp terminal 5 x 6 mm² nominal cross-section

7012012 white

16.05 €



Stove connecting box flat



For flush mounting.

- 16 A/400 V
- with claw-type holder
- for 55 mm wall box, height 12 mm
- with screw clamp 5 x 2.50 mm² and pull relief
- clips with colour coding correspond to the valid wire colours
- with snap lid

7012025 white

12.10 €



Stove connecting box WAGO clamps



For surface and flush mounting.

- 16 A/V400 V
- screwless clamping points up to 6 mm²
- for 55 mm wall box, H 12 mm
- swivelling strain relief
- double cable outlet (5 x 2 mm², 3 x 4 mm²)
- with snap-on lid

7012028 white

35.21 €

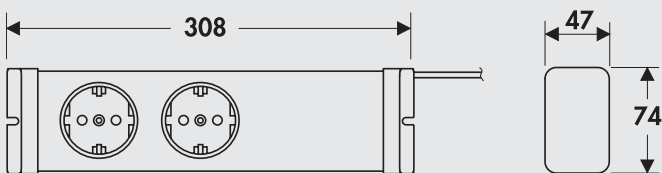

Vario energy distributor

With 1500 mm mains connection cable. The Vario power distributor controls the interaction of strong consumers with high connection values to a 230 V/16 A safety socket.

Given simultaneous operation of two appliances with high energy consumption (e.g. washing machine and dryer or dishwasher and boiler), during the heating phase of the appliances, the supply line may become overloaded and, as a result, the circuit breaker may be activated.

The Vario power distributor recognises this and switches off one appliance to avoid triggering of the circuit breaker.

For example, if a washing machine is operated in the black socket and a dryer in the white socket, the dryer is switched off briefly during the heating phase of the washing machine. Once the heating process of the washing machine finishes, the dryer is automatically switched back on again. If the white socket is switched on, the red function display is also automatically lit. A 2-pole illuminated rocker switch also makes it possible to disconnect all the connected consumers from the mains so as to avoid potential danger sources. The extended contact protection offers you and your family additional safety.

- disconnection by overload protection at approx. 3400 W
- reconnection at approx. 450 W

7011064 silver

102.52 €



Wago connecting clamp

- 3 clamping points with operating lever
- nominal cross-section 0.14–4 mm²
- colour transparent
- nominal voltage 450 V
- nominal current 32 A
- suitable for solid conductors, flexible conductors, multiple conductors
- **only available in units of 50 piece**

7011039 transparent, Price per PU

53.87 €



Wago feed-through terminal

- 2 clamping points with operating lever
- nominal cross-section 0.2–4 mm²
- colour transparent
- nominal voltage 450 V
- nominal current 20 A
- suitable for solid conductors, flexible conductors, multiple conductors
- **only available in units of 60 piece**

7011097 transparent, Price per PU **63.70 €**



Duct tape

- L 10 m
- W 15 mm

7011052 white **4.45 €**



Moveable flange



For switch box. Suitable for niche rear walls.

- H 12 mm
- Ø 60 mm

7011043 red **2.10 €**

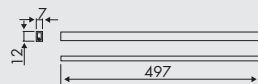

Cable duct

Plastic duct with duct tape. Suitable for LED and halogen spots.

- 497 x 12 x 7 mm (L x W x H)

7011088 L 497 mm, stainless steel coloured **2.94 €**

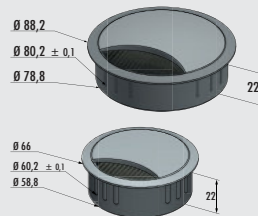

Cable feed-through metal

Round. With brush. Made of Zamak (zinc die-cast).

- shaft height 22 mm

7011090 Ø 80 mm, stainless steel coloured **26.22 €**

7011091 Ø 60 mm, stainless steel coloured **22.52 €**

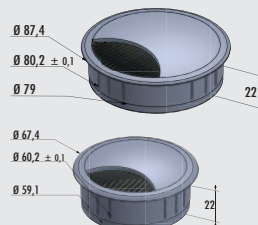

Cable feed-through plastic

Round. With brush.

- shaft height 22 mm

7011092 Ø 80 mm, silver-painted **6.89 €**

7011093 Ø 60 mm, silver-painted **4.96 €**

7011095 Ø 80 mm, black matt **5.80 €**

7011096 Ø 60 mm, black matt **3.95 €**

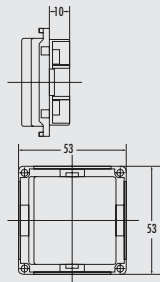

Rocker switch



- contact one-pin outlet
- switching voltage 230 V
- switching current 16 A

7013046 silver coloured

20.00 €

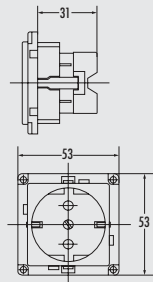

Earthed plug socket



- voltage 230 V
- current 10/16 A

7013047 silver coloured/black

26.97 €

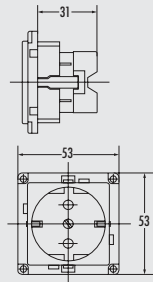

Earthed plug socket with flip lid



- voltage 230 V
- current 10/16 A

7013048 silver coloured/black

33.95 €

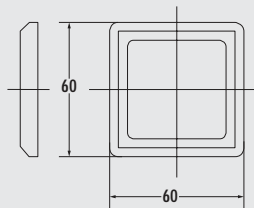

Cover frame 1

- 1-fold. For switches and sockets.
– plastic

7013049 silver coloured

14.29 €

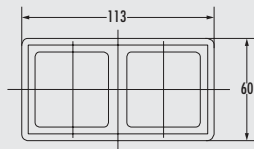

Cover frame 2

- Double. For switches and sockets.
– plastic

7013050 silver coloured

19.75 €

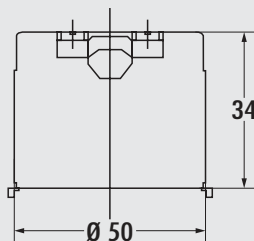

Flush mounted box 1

- 1-fold. For switches and sockets.
– plastic
– drill Ø 50 mm
– installation depth 34 mm
– pull relief 1 outlet at side

7013044 black

3.61 €

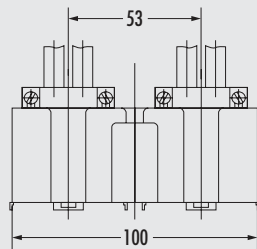

Flush mounted box 2

Double. For switches and sockets.

- plastic
- drill \varnothing 2 x 50 mm
- installation depth 40.5 mm
- pull relief 2 outlets at side

7013045 black

8.40 €

MONTEC®

Connecting materials

They keep their promise



Fitting materials

■ Side profile	Page 146
Steam protection plates	Page 146
Alukleb	Page 146
RAUKANTEX Foliex	Page 146
Heat protection plates	Page 146
Suspension strip	Page 147
Brackets	Page 147–149
Splices	Page 149
Worktop fastening bracket	Page 149
Stabilising strip	Page 149
Punched tape	Page 149
Worktop joint	Page 150
Silicone rubber	Page 150
Caulking set	Page 150
Installation glue	Page 150
Ceramic stove top cleaner	Page 150
Glass scraper	Page 150
Stainless steel cleaner Utral	Page 151
Stainless steel care agent	Page 151
Cleaning spray for artificial leather	Page 151
Stainless steel system care	Page 151
Care set Cin-Nagranit	Page 151
Soundproofing in the kitchen	Page 152
Rubber bushing	Page 153
Rubber pad	Page 153
Rubber rondel	Page 153
Rubber strip	Page 153
PE strip	Page 153
PE edge strip	Page 153

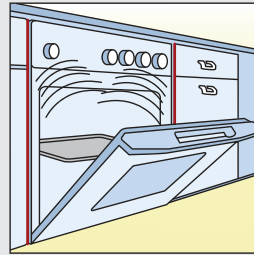
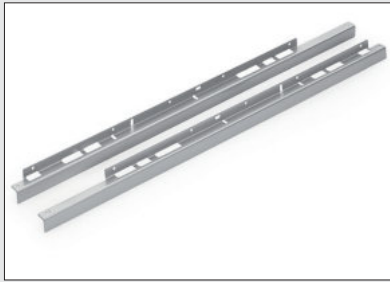

Side profile

The steel profiles are attached to the side body edges of the stove housing. The profiles chamfered to the front protect the laterally connecting body sides against all possible heat emission. The side profiles are fitted with punch holes for oven fastening.

- for side walls of 16 mm
- only available in PU of 2 pieces

9015015 L 600 mm, silver coloured, price per PU

15.97 €

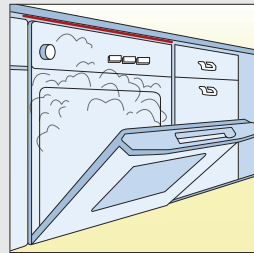

Steam protection plate 1

The galvanised steam protection plate is fastened above the dishwasher door, on the lower edge of the worktop. It prevents the steam emitting when opening the dishwasher from penetrating the worktop and causing it to swell over time. Incl. mounting material.

9015011 L 450 mm, silver coloured

18.49 €

9015012 L 600 mm, silver coloured

19.58 €

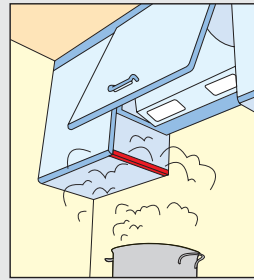

Steam protection plate 2

Prevents swelling of the cabinet sides.

- depth 335 mm
- height 30 mm
- chamfering 19 mm
- thickness 1.5 mm
- incl. mounting material
- only available in PU of 2 pieces

9015031 silver coloured, price per PU

28.49 €



Alukleb A2

Pure aluminium adhesive tape according to DIN 4102, non-flammable (A2).

- film thickness 0.025 mm
- W 50 mm
- 1 roll = 10 m

4061039 aluminium

9.58 €



RAUKANTEX Foliex

With RAUKANTEX Foliex protective films can be removed more quickly and precisely.

- easy to use
- little effort required
- faster assembly

9013003 beech

40.42 €

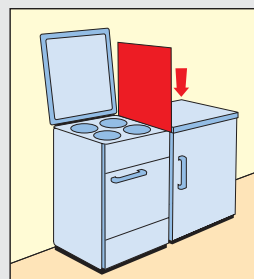

Heat protection plates

For use between the refrigerator and the stove. Fitted with a nickel-coated frame on all sides, front side clad with aluminium foil, which is characterised by high light reflection and heat radiation.

- temperature stability up to max. +750 °C
- 800 x 500 mm (H x D)
- thickness 3 mm

9015030 aluminium

83.61 €



Suspension strip for kitchen cupboards

With galvanised surface, completely perforated with round and elongated holes.
 – profile thickness 1.75 mm
 – distance between individual holes approx. 20 mm
 – distance between elongated holes approx. 140 mm

8031080 L 2000 mm, galvanised **16.39 €**

Optional accessories

8031081 Special screws, galvanised, price per PU of 100 pieces **23.61 €**



Top safe fitting

Special safety fitting for fastening wall cabinets according to DIN EN 1153, also for bridging electrical cables.

1111145 140 x 50 x 10 mm, zinc-coated **16.72 €**

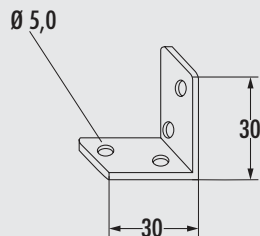

Bracket 1

- thickness 2 mm
- sides 30 x 30 mm
- width 25 mm

1111101 galvanised **1.51 €**

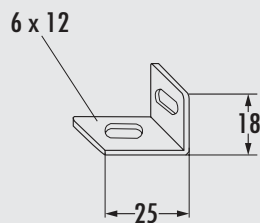

Bracket 2

With horizontal and vertical elongated holes.

- thickness 1.5 mm
- sides 25 x 18 mm
- width 20 mm

1111102 galvanised **1.43 €**

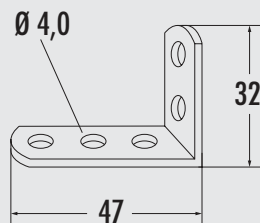

Bracket 3

Blade angle.

- thickness 2 mm
- sides 47 x 32 mm
- width 18 mm

1111103 galvanised **1.51 €**

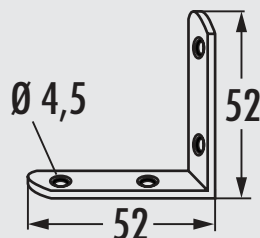

Bracket 4

- thickness 2 mm
- sides 52 x 52 mm
- width 15 mm

1111104 galvanised **1.76 €**

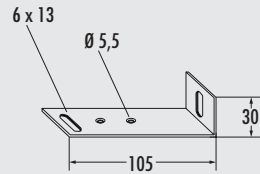

Bracket 5

With elongated holes (bracket tipping protection).

- thickness 1.5 mm
- sides 105 x 30 mm
- width 20 mm

1111105 galvanised 1.85 €

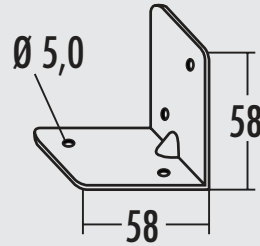

Bracket 6

With pleat.

- thickness 2 mm
- sides 58 x 58 mm
- width 60 mm

1111106 galvanised 2.61 €

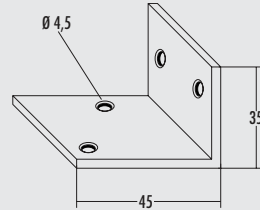

Bracket 7

- thickness 3 mm
- sides 45 x 35 mm
- width 50 mm

1111107 galvanised 8.07 €

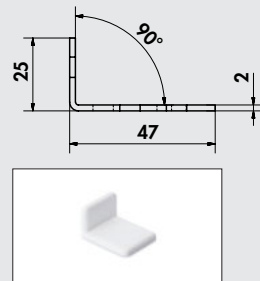

Euro-bracket

Universal bracket.

- thickness 2 mm
- sides 47 x 25 mm
- width 35 mm

1111123 galvanised 2.27 €

Optional accessories

1111124 Covering cap, white 2.27 €

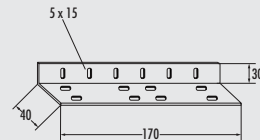

Bracket 8

- thickness 2 mm
- sides 40 x 30 mm
- width 170 mm

1111108 galvanised 6.89 €

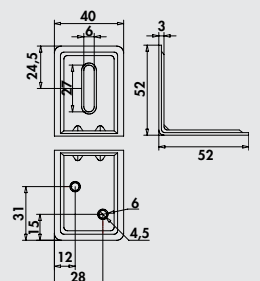

Bracket 9

- thickness 3 mm
- sides 52 x 52 mm
- with pleat

1111144 zinc-coated 2.44 €

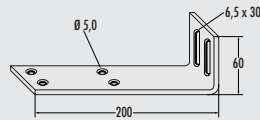

Upper shelf bracket

— sides 200 x 60 mm

Including accessories bag:

- 2 x wood screws 5.5 x 6 mm
- 2 x tooth lock washers galvanised 6.4 mm
- 2 x KS multi-purpose dowels
- 4 x chipboard screws 4 x 16 mm

1111109 white **21.26 €**

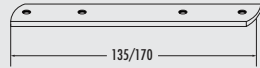

Splices

Straight, for joining door strike plates. Thickness 3 mm.

1111110 L 135, W 20 mm, chrome-plated **4.12 €**

1111111 L 135, W 20 mm, white **3.45 €**

1111112 L 135, W 20 mm, silver **3.53 €**

1111113 L 170, W 20 mm, chrome-plated **4.20 €**

1111114 L 170, W 20 mm, white **3.53 €**

1111115 L 170, W 20 mm, silver **4.12 €**

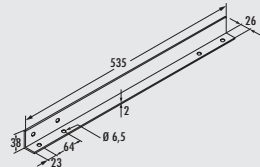

Worktop fastening bracket

Supporting bracket for kitchen worktops.

1111119 L 535 mm, white **20.34 €**

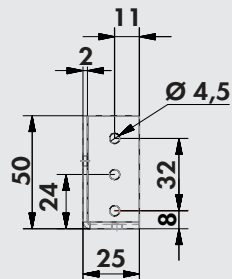

Stabilising strip

The stabilising strip for 16 mm sidewalls can be used universally as a spacer bar and in combination to support the worktop. This can be used upright as well as flat, depending on the requirement. Due to the design, a wooden panel can also be fitted in front mounting.

— to support long and narrow worktops

1111125 L 567 mm, white **55.29 €**

1111126 L 767 mm, white **61.68 €**

1111127 L 867 mm, white **61.93 €**

1111128 L 967 mm, white **62.77 €**

1111129 L 1167 mm, white **68.99 €**



Punched tape

High strength installation punched tape made of galvanised steel in plastic dispenser. For fastening pipes, rods, cables, ducts, air ducts, etc.

— W 17 mm

— L 10 m

5031049 galvanized steel **20.59 €**



Worktop joint

Steel connecting element for kitchen worktops. Metal bend for drill hole 60 mm Ø, completely assembled with installation aids and long nut M6.

1111039 M6 x 150 mm, galvanised 4.20 €



Silicone rubber

Permanently elastic sealing compound for joints and industrial bonding. Very easy handling due to the dispenser cartridge, excellent bond to metal, glass, concrete, wood and plastic.

Not suitable for granite.

– temperature resistant from –40 °C to +150 °C

1111040 310 ml cartridge, transparent 20.92 €

1111041 310 ml cartridge, white 20.92 €



Caulking set

Create silicone joints like a professional – it's the only way to achieve clean and uniform joints. Push the cartridge tip as far as it will go through the central hole of the hand gun and cut it off at the furthest point.

Set consisting of:

- silicone scraper 6 mm
- caulking tool
- cleaning set

1111002 orange 21.68 €



Installation glue

1-component, elastic adhesive on hybrid basis with very high initial adhesion. Suitable for indoor and outdoor use, can be painted over if necessary (refer to the special instructions for this).

1111042 290 ml cartridge, white 17.14 €



Ceramic stove top cleaning agent CLEANER

An economical cleaning agent for daily cleaning and care of ceramic and induction stove tops. After each cleaning, the CLEANER creates a film which facilitates the next cleaning. CLEANER is also excellently suited for cleaning copper and chrome. Does not contain formaldehyde, solvents, phosphates or nitrates.

1111130 200 ml 16.47 €



Glass scraper

For cleaning glass and ceramics, with integrated blade protection. Stainless steel with steel blade.

1111131 stainless steel 10.76 €

Optional accessories

1111132 Three-hole blade, 5 pc. in packet 6.55 €



Stainless steel cleaning agent Utral

Cleaning agent for stainless steel surfaces, metallic grease filters and ovens. With very strong dirt and grease dissolving properties.

1111142 250 ml

14.96 €



Stainless steel care agent Edelglanz

Care agent in a spray bottle for stainless steel and chrome surfaces. Spots, finger marks and scum disappear without a trace. The surface shines like new. Economical use.

1111143 250 ml

23.36 €



Cleaning spray for artificial leather

A special cleaning spray that has been developed with a specific formulation that enables effortless cleaning of artificial leather.

1111139 500 ml

14.87 €



Stainless steel system care

Our stainless steel sinks with high-gloss surface are manufactured with great care and using state-of-the-art manufacturing and processing technology. The stainless steel applied for this is subject to strict quality control and ensures a constant high quality level of the sinks.

The material properties of stainless steel 18/10 – according to the current state of the art – exclude absolute scratch-proofing. Therefore, the occurrence of small scratches is normal. Only after regular care using the recommended stainless steel system care, will you achieve a semi gloss surface after about 2–4 weeks.

Note

When cleaning, make sure that the stainless steel surface is not processed against the grain!

1111141

17.98 €



Care set Cin-Nagranit

Set consisting of 3 bottles à 50 ml incl. eraser sponge.

- 1 x easy care product
- 2 x descaler/stain remover

1100003

32.35 €

Sound-proofing in the kitchen



Minimising noise sources, enhancing wellbeing, increasing living comfort!

Good sound insulation with the Naber "SOUND of SILENCE" system

The noises produced when using a kitchen can be passed by structure-borne sound transmission to the adjacent room or the neighbouring apartment. Sounds like chopping or banging, putting down pots and hard objects on the kitchen worktop are transmitted through the furniture and wall into the adjacent units. Further disturbing noises occur when putting away dishes, pans, bottles or cans in cupboards, drawers and pull-outs.

Without noise protection measures, structure-borne sound is transmitted, through the fixed built-in kitchen and into the walls and floor of the building structure. The results are disturbing, easily perceived noises from adjacent flats or rooms. To avoid this, the fixtures and contact points of the kitchen cabinets have to be acoustically decoupled from the building structure.

With the Naber "SOUND of SILENCE"-sound-proofing and insulation components – sound transmission points can quickly and easily be insulated and decoupled from the building structure during the kitchen installation.

Advantages of the Naber "SOUND of SILENCE" sound protection and insulation components for kitchens:

- tested according to SIA standard 181:2006 – the increased requirements are met
- suitable for installation in single-shell concrete party walls
- only 4 mm thick decoupling from building structure required
- for kitchens according to Swiss and Euro standard

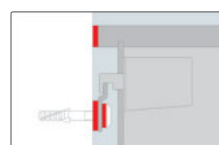
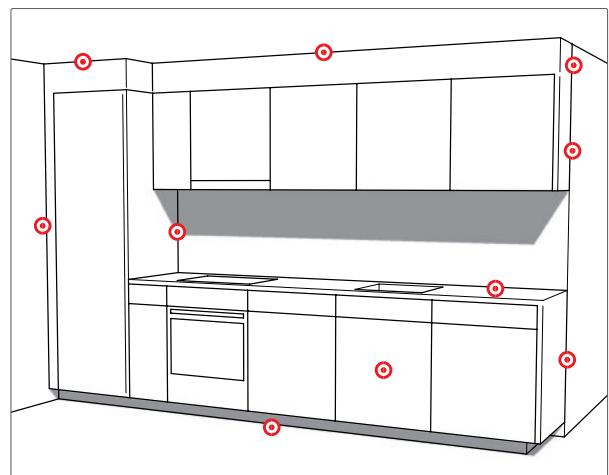

Fasten rail with rubber pads and rubber sleeves, decouple cupboard lid or side walls with rubber band.



Decouple feet with rubber washers and frame from the floor with rubber band.



Decouple the worktop from the wall at the front using PE edge band or PE band.



Decouple cupboard floor or side walls with rubber band.



Decouple frames from the wall using PE band.



Rubber bushing with washer

For suspension rails. Decoupling for screw head and shaft, made of rubber 45° Shore A.

- for 5 mm screws
- \varnothing i 10 mm, \varnothing o 16 mm
- L 5 mm
- **only available in units of 10 pieces**

1112008 black, price per PU **10.50 €**

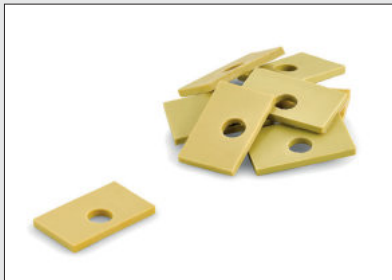

Rubber pad

Decoupling cupboards and suspension rails, self-adhesive, with through hole, made of rubber 45° Shore A.

- 4 x 50 mm (H x L)
- **only available in PU of 10 pieces**

1112002 \varnothing of the hole 12 mm, W 30 mm, price per PU **13.87 €**



Rubber rondel

Decoupling for adjustable feet self-adhesive with sliding film made of rubber 45° Shore A.

- H 4 mm
- **only available in PU of 50 pieces**

1112010 \varnothing 60 mm, price per PU **136.13 €**



Rubber strip

Robust strip for decoupling, self-adhesive, made of rubber 45° Shore A.

- L 10 m
- 4 x 13 mm (H x W)

1112005 white **65.46 €**



PE strip

Strip to secure spacing, self-adhesive, made of closed-cell PE, density 33 kg/m³.

- L 10 m
- 4 x 15 mm (H x W)

1112012 white **13.70 €**



PE edge strip

Strip to secure spacing of the front and top surfaces of worktops, self-adhesive, with longitudinal cut, made of closed-cell PE 33 kg/m³.

- L 20 m
- 4 x 50 mm (H x W)

1112007 white **109.24 €**

Fitting materials